

Repair Manual



FORDSON MAJOR

(1952-1958)

POWER MAJOR

SUPER MAJOR

THE NEW

FORDSON MAJOR

MANUFACTURED IN ENGLAND BY
FORD MOTOR COMPANY LTD.

Repair Manual



FOREWORD

This manual is written to assist in the efficient repair of the New Fordson Major Tractor. Wherever possible, each operation is self-contained and sufficient detail is given to ensure that unnecessary dismantling will be avoided.

Special tools have been developed to assist when carrying out the work and reference has been made to these tools in the appropriate places. The tools are numbered according to the Basic Part Number of the component in question.

All necessary specifications, repair data and wear limits are quoted at the end of each section and will be of assistance when deciding if parts are suitable for further service.

Whenever reference is made to the right- and left-hand side of the tractor, this is as viewed from the Driver's seat, facing forward.

The tractor number is the same as the engine number which is stamped on the left-hand top face of the flywheel housing flange. This number is also stamped on a plate attached to the engine front bulkhead.

Ford Policy is one of continuous improvement and the right to change prices, specifications and equipment at any time without notice is reserved.

CONTENTS

7 SECTION	PAGE NO.
Engine--Diesel	5
—Petrol—Vaporising Oil	35
—Lubrication System	59
Cooling System	68
Fuel System—Diesel	75
—Fuel Tanks and Fuel Supply Taps	99
— Petrol/Vaporising Oil	103
Separating the Tractor	115
Clutch	119
Front Transmission—Gearbox	129
Rear Transmission—Rear Axle	137
Hydraulic System	147
Front Axle	167
Steering Gear	173
Braking System	179
Wheels and Tyres	187
Electrical System	191
Power Take-off Equipment	231
Index	242
Supplement	245

COPYRIGHT IN GREAT BRITAIN, JANUARY 1954.
Reproduction in any manner, in whole or in part, prohibited
without the express permission in writing of Ford Motor
Company Limited, 88 Regent Street, London, W.1, England.

THE DIESEL ENGINE

The 3.61 litre, four cylinder, direct injection type diesel engine fitted in the New **Fordson Major** Tractor has a bore diameter of 100 mm, and a stroke of 115 mm.

Overhead valves are employed operated by push rods from a gear driven camshaft located in the right-hand side of the cylinder block. The compression ratio is 16 to 1.

The valves are fitted vertically in the cylinder head, the inlet valve head being larger than the exhaust. The valve guides are replaceable.

Aluminium alloy pistons are employed with a combustion chamber machined in the crowns and have three **compression** rings and one oil ring above the piston pin and one **oil** control ring below the piston pin. The piston pins are fully floating and are retained in position by two **circlips**.

Detachable wet cylinder liners are fitted, flange-mounted in the top face of the cylinder block and retained in position by the cylinder head.

The crankshaft is supported in five large diameter main bearings. These bearings and the connecting rod **big** end bearings are of the detachable steel-backed lead-bronze type. Crankshaft end-float is controlled by detachable thrust washers fitted at each side of the centre main bearing.

An **enclosed** camshaft type fuel injection pump is driven from the rear end of the auxiliary drive shaft and feeds multi-holed type injectors located at an angle in the top of the cylinder head.

The engine speed is controlled by a pneumatic governor **mounted** on the **fuel injection** pump. An excess fuel device is fitted to assist cold starting.

On current engines rotator type exhaust valves are fitted. A cap located over the end of the valve stem transmits pressure from the rocker lever to the spring retainer and valve spring. This anion allows the valve to remain free throughout its operating cycle.

A decompressor, operating on all valves, was fitted to early type engines. On current engines this is optional equipment.

Note — The operations described in the following pages are each complete in themselves and used in conjunction with the instructions from page 31 onwards give detailed information for a complete engine strip down and rebuild.

These instructions have been prepared in order that the operations **may** be completed in the quickest time, involving the removal of the least number of component parts.

A guide as to whether a part is fit for re-use or not is given in the form of wear limits tabulated at the end of the section. In the case of a complete overhaul of the engine, discretion must be exercised when re-fitting parts which, although within the limits, may be subject to arduous service when reassembled.

THE ROCKER SHAFT ASSEMBLY

To Remove

- 1 Undo the adaptor nut securing the ventilation pipe from the rocker cover to the inlet manifold.
- 2 Unscrew the two securing bolts and remove the rocker cover and gasket.
- 3 Release the retaining nut on the decompressor control (where fitted) and disengage the inner end of the control from the rocker shaft lever.
- 4 Release the tab washers on the five rocker shaft bolts. Gradually unscrew the bolts and lift off the rocker shaft, taking care not to dislodge the rotator caps from the exhaust valves if this type of valve assembly is fitted. (See Fig. 1.)
- 5 Lift out the push rods from their block locations, keeping them in their correct order and remove the rotator caps which should also be kept in their correct order.

Note — It is possible to change a push rod without removing the rocker shaft. This is done in the following manner: make sure that the valve in question is closed, slide the valve rocker sideways off the valve stem, until its ball end can be disengaged from the push rod cup.

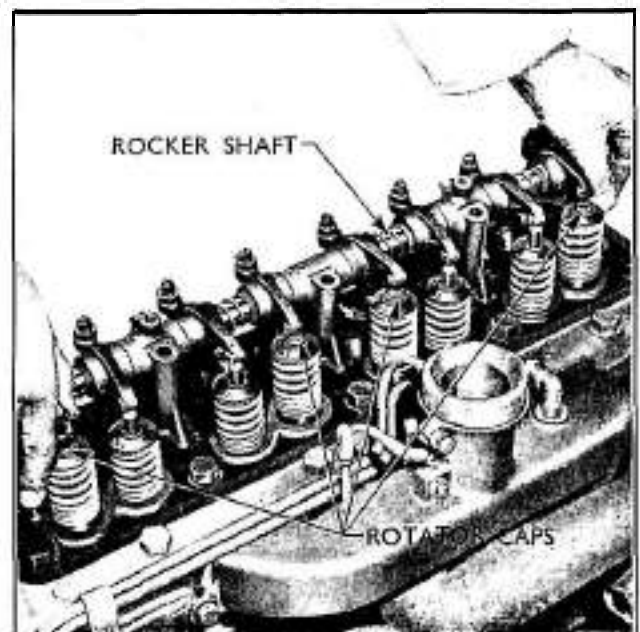

Fig. 1
Removing the Rocker Shaft

To Dismantle

Note — Where a decompressor lever is not fitted the eccentric sleeves and keys referred to are also not fitted, and the build-up is similar to that used on the Petrol and Vaporising **CI** engines with the exception of the rocker levers.

- 1 Stand the assembly on end with the decompressor lever uppermost, push the rocker levers, springs, eccentric sleeves and support brackets downwards until the pin retaining the decompressor lever or the end plug is revealed. Remove the pin and withdraw the decompressor lever or end plug assembly. (See Fig. 3.)
- 2 Pull off the adjacent support bracket, then the two rockers, spacer spring and eccentric sleeve. This will disclose the eccentric sleeve key, which must be removed before the next support bracket can be pulled off the shaft. Remove the remaining parts in a similar sequence and extract the keys as they are revealed.
- 3 Finally, remove the front plug after removing the retaining pin.

To Reassemble

- 1 Fit the front end plug and retaining pin to that end of the shaft which has the pin hole centrally drilled.
- 2 Fit the support brackets, keys, eccentric sleeves, rocker levers and spacer springs in their correct order as shown in Fig. 2. The front and rear brackets are interchangeable, as also are the intermediate brackets, which are identified by a tapped hole for the rocker cover bolt. Ensure that the support bracket bolt holes are to the right viewing the shaft from the front end, with each pair of rocker levers inclined towards each other at the valve end.



Fig. 3
Decompressor Lever

- 3 Complete the assembly by pushing all the parts towards the front of the rocker shaft and fitting the decompressor lever and its retaining pin.

To Replace

- 1 Fit the push rods in their original position and place the rotator caps on the exhaust valve stems if this type of valve assembly is fitted. Care should be taken to prevent these caps falling in the engine.

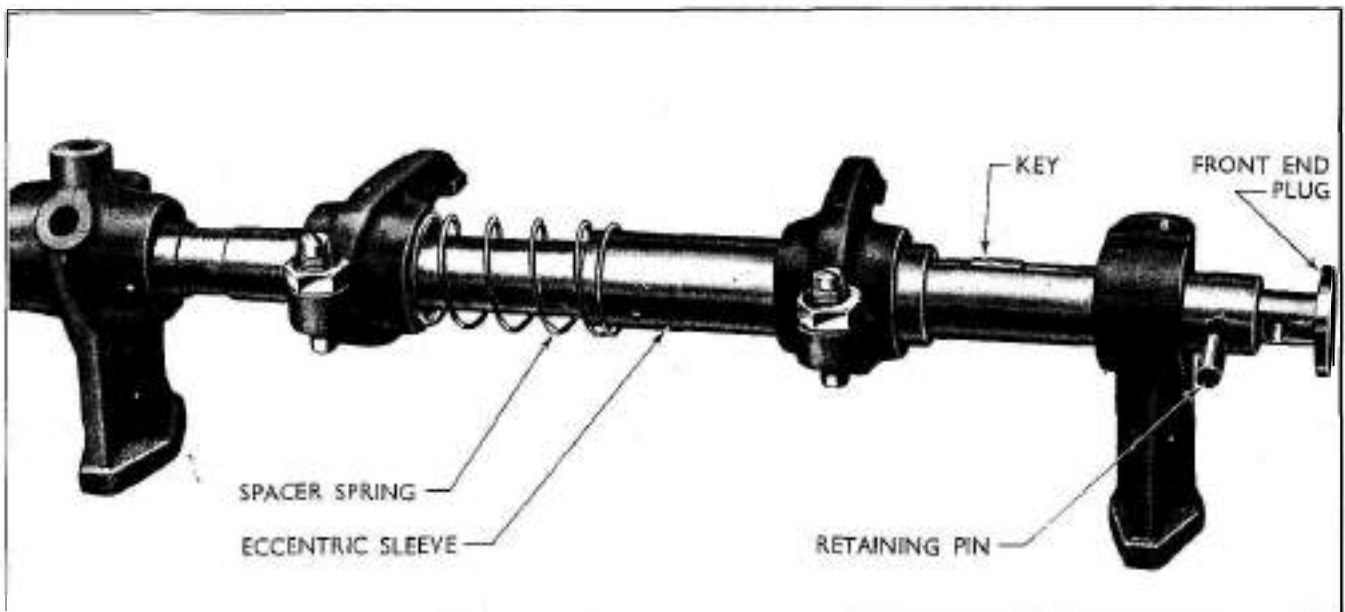

Fig. 2
Rocker Shaft and Supports

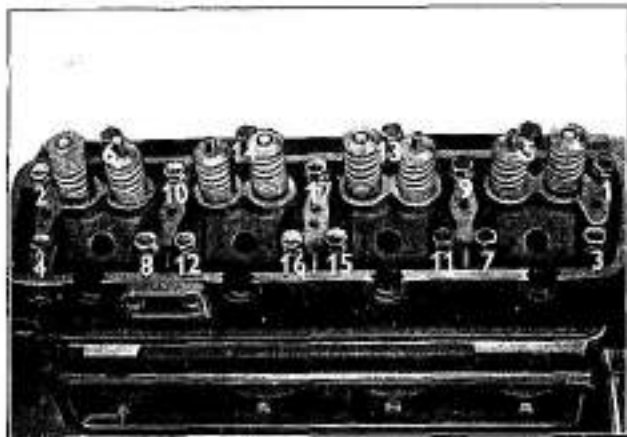

Fig. 4

Correct Sequence for Loosening Cylinder Head Bolts

- 2 Fit the rocker shaft to the cylinder head, entering the adjusting screw ball ends in the push rod cups and engage the decompressor control with the decompressor lever.
- 3 Fit and tighten down evenly the five rocker shaft support bracket bolts and lock with the tab washers.
- 4 Adjust the valve clearances initially to 0.015 in. for inlet valves and exhaust valves without rotators. Rotator type exhaust valves should be set to 0.012 in. Ensure that all locknuts are tightened.

Note — Ensure that the decompressor control is pushed in and the locking nut screwed in before carrying out the valve adjustment.

- 5 Warm up the engine and if necessary readjust the valve clearance to 0.015 in. for inlet valves and exhaust valves without rotators and 0.012 in. for rotator type exhaust valves.
- 6 Fit the rocker cover and gasket and tighten down the two securing bolts which are fitted with folded copper sealing washers.
- 7 Fit the ventilation suction pipe between the rocker cover and the inlet manifold.

CYLINDER HEAD ASSEMBLY AND GASKET**To Remove**

- 1 Disconnect the negative cable from the battery terminal post.
- 2 Remove the radiator filler cap and drain the water from the cooling system through the two taps, one on the radiator and one on the left-hand side of the cylinder block.
- 3 Disconnect the radiator tie bar, remove the water outlet connection and lift out the thermostat.
- 4 Remove the temperature gauge connection from the front of the cylinder head.
- 5 Remove the rocker cover, gasket, rocker shaft and push rods as described on page 5.

- 6 Remove the injectors as described in the Fuel System Section.
- 7 Remove the inlet and exhaust manifolds as described on page 8.
- 8 Unscrew the seventeen bolts retaining the cylinder head to the cylinder block in the order shown in Fig. 4.
- 9 Lift off the cylinder head and remove the gasket and rocker shaft oil feed seal.

Note — Current type cylinder head bolts are marked “100” on the head.

To Replace

- 1 Thoroughly clean off all dirt, carbon, etc., from the cylinder block, cylinder head faces and the recess in the cylinder block for the rocker shaft oil feed seal.
- 2 Fit a new rocker shaft oil feed seal and screw the cylinder head locating studs (tool No. TTr/MD 6050) into opposite corners of the cylinder block face and locate the new cylinder head gasket in position.
- 3 Replace the cylinder head and screw in the seventeen bolts and tighten in the correct order, as shown in Fig. 5, to the correct torque shown in the specification.
- 4 Replace the inlet and exhaust manifolds as described on page 8.
- 5 Replace the injectors as described in the Fuel System Section.
- 6 Replace the rocker shaft, push rods, rocker cover and gasket, and adjust valve clearances as described on this page.
- 7 Replace the temperature gauge connection in the front of the cylinder head.
- 8 Refit the thermostat, water outlet connection and the radiator tie bar.
- 9 Refill the cooling system.
- 10 Reconnect the battery lead to the battery terminal post.

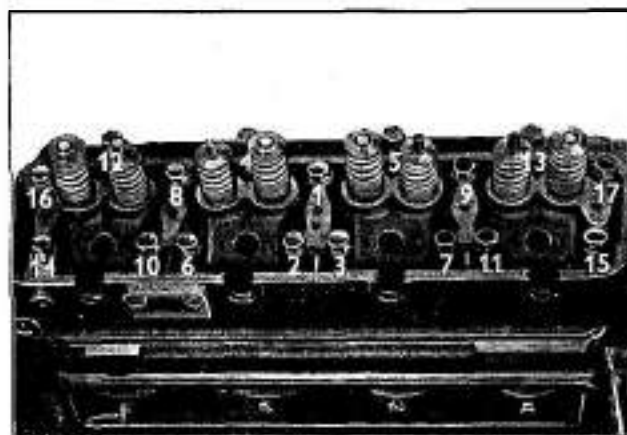

Fig. 5

Correct Sequence for Tightening Cylinder Head Bolts

THE INLET AND EXHAUST MANIFOLDS

To Remove

- 1 Lift off the vertical type exhaust pipe. If the horizontal type is fitted, disconnect the pipe at the manifold.
- 2 Unscrew the clips at either end of the rubber hose between the air cleaner and the inlet manifold and remove the hose.
- 3 Disconnect the throttle control rod.
- 4 Disconnect, at the manifold end, the two suction pipes from the pneumatic governor. Also disconnect and remove the ventilation suction pipe between the rocker cover and the inlet manifold.
- 5 Unscrew the manifold to head bolts and lift away the manifolds.

i o Replace

- 1 Fit the manifolds using new gaskets, and screw in the retaining bolts evenly, making sure that the clamping washers are correctly positioned in their recesses.
- 2 Connect the pneumatic governor suction pipes, making sure that the bleed pipe (i.e. the outer pipe on the governor casing) is fitted to the upper connection on the inlet manifold, and refit the ventilation suction pipe between the rocker cover and the inlet manifold.

NOTE — THE ENGINE MUST NOT BE RUN WITH THE GOVERNOR PIPES DISCONNECTED, AS UNDER THESE CONDITIONS THE GOVERNOR IS INOPERATIVE, AND SERIOUS DAMAGE MAY RESULT.

- 3 Reconnect the throttle control rod.
- 4 Refit the rubber hose between the inlet manifold and the air cleaner.
- 5 Replace the horizontal type exhaust pipe with two bolts and a nut, or if vertical type, replace in adaptor.

VALVES, GUIDES AND SPRINGS

The valves are mounted vertically in the cylinder head and operated from the camshaft by conventional type push rods and rocker arms. The diameter of the inlet valve head is greater than that of the exhaust valve to improve engine breathing.

On current engines rotator type exhaust valves are fitted and the operation of these is described overleaf. The inlet valve on all engines remains the same.

Oil seals are fitted to the stems of all valves with the exception of the rotator type exhaust valves.

To Renew a Valve Spring (without removing the cylinder head)

- 1 Remove the rocker cover and rocker shaft assembly, push rods and rotator caps (if fitted), as described on page 5.
- 2 Turn the piston on the cylinder beneath the valve affected, to the top of its stroke.
- 3 Refit a rocker shaft support bolt adjacent to the affected valve, slide the block of the valve spring compressor (tool No. TTr/D 6513) under the bolt head and tighten down the bolt. Pull down the cam handle to compress the valve and extract the collets. (See Fig. 6.)
- 4 Release the cam handle and remove the spring retainer, valve spring and rubber sealing ring.
- 5 Fit a new valve spring with the close-coiled end to the cylinder head and replace the spring retainer. Compress the valve spring and fit a new rubber sealing ring into the lower groove of the valve stem where applicable and locate the collets.
- 6 Remove the tool and replace the push rods, rotator caps, rocker shaft assembly and rocker cover, as described on page 6.
- 7 Readjust the valve clearances to the figure specified.

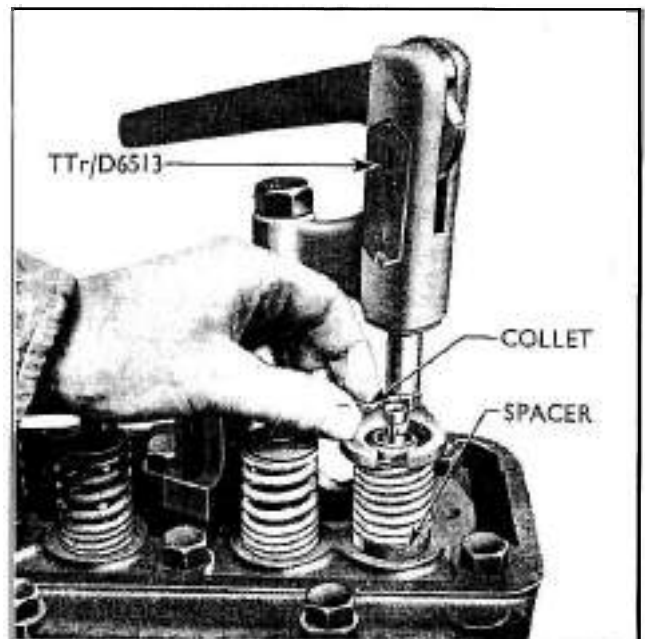

Fig. 6
Valve Spring Compressor

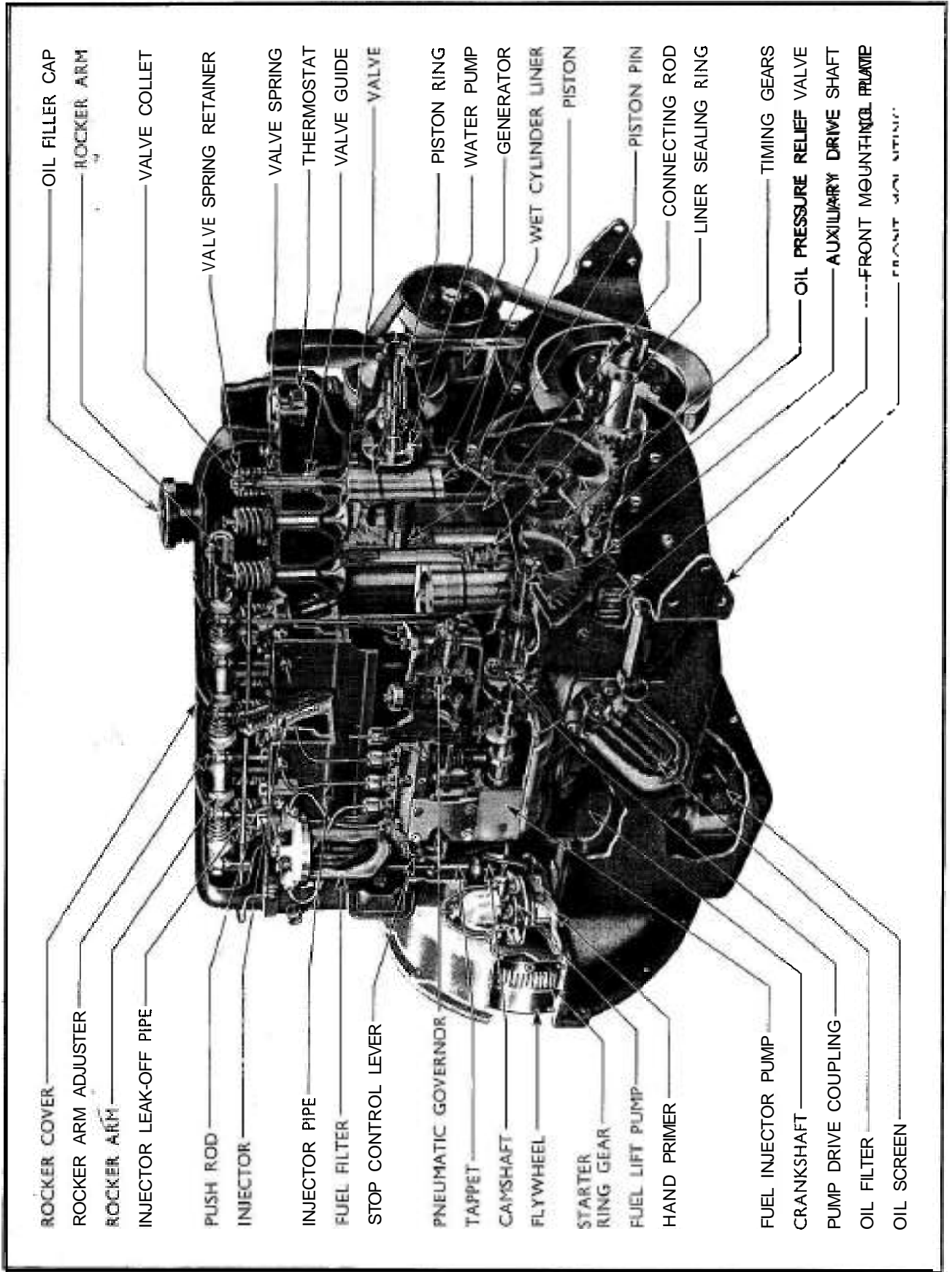

Fig. 7

Sectioned View of Diesel Engine

Rotator-type Exhaust Valves

Engines equipped with rotator type exhaust valves (see Fig. 8) can be identified without removing the rocker cover, by inspecting the valve assemblies through the oil filler aperture. If this type exhaust valve is fitted, the overall height of the exhaust valve spring assemblies is much greater than those of the inlet valves. In addition, the valve spring retainers on the exhaust valves are approximately flush with the valve stem ends.

The cylinder head incorporating this type of exhaust valve assembly does not have a recess for the exhaust valve spring in the cylinder head. Recesses are still provided for the inlet valve springs. (See Fig. 9). These heads also incorporate solid type injector housings.

A small cap is fitted over the end of the valve stem, so that the pressure from the rocker lever is transmitted direct to the valve spring retainer and valve spring, and the valve itself is relieved of spring pressure during the working cycle.

To achieve this condition, a slight clearance exists between the valve cap and the end of the valve stem (see Fig. 10).

It is important that this clearance of between 0.002 in. and 0.006 in. is maintained.

If the clearance is insufficient, then the valve may not be relieved of the spring pressure during the working cycle, or if it is excessive, the valve may hammer on the collets and lead to excessive wear.

In service, the depth of the cap can be determined either by using a depth micrometer or by measuring the overall length of the cap, and subtracting from it the thickness of the top of the cap. The distance from the end of the valve stem to the outer end of the collet groove should also be measured carefully.

The difference in these two dimensions thus obtained should be between 0.002 in. and 0.006 in. With new parts the manufacturing tolerances are such that the clearances should always be within the limits specified.

After the valves have been in service for some time, a small amount can be polished off the open end of the cap if the clearance exceeds 0.006 in. or from the valve stem end if the clearance is less than 0.002 in.

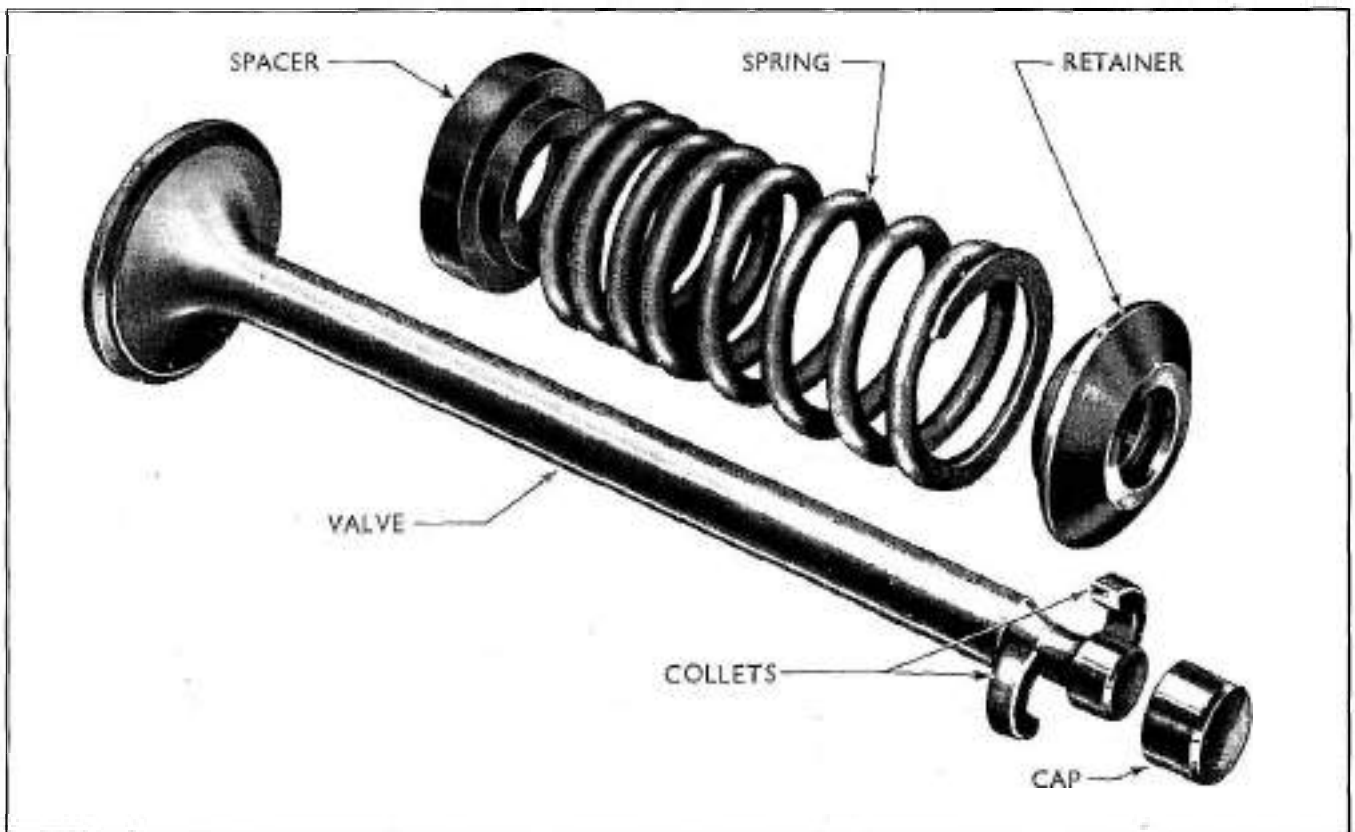

Fig. 8
Rotator Type Exhaust Valve

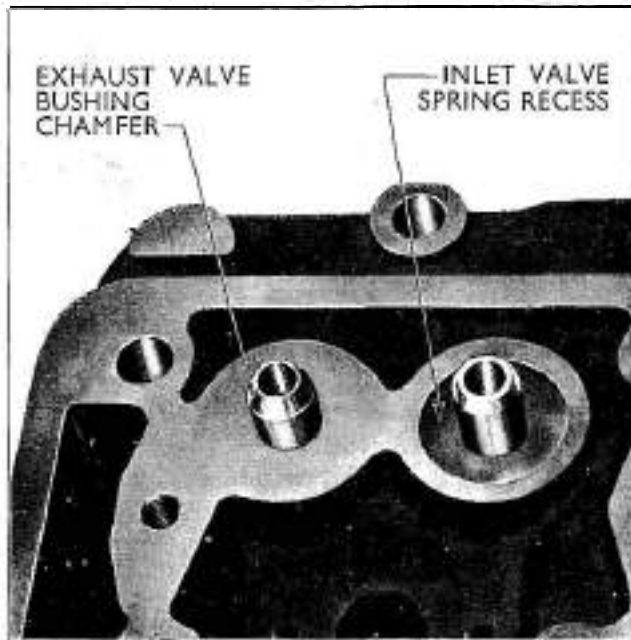

Fig. 9

Short Exhaust Valve Guide and Spring Recess

The faces of the collets which contact the cap must be flat and square.

A number of engines were produced having a cylinder head incorporating integral type injector housings but without rotator type exhaust valves.

These cylinder heads do not incorporate the short exhaust valve guides as do the current engines but they do have recesses for both exhaust and inlet valve springs.

It is possible to fit the rotator type exhaust valve assemblies to all cylinder heads having solid type injector housings. On heads having recesses for the exhaust valve springs a valve spring recess spacer will be required for each valve spring location.

Removal and replacement of rotator type exhaust valves is carried out in the same way as the early type, except that particular care should be taken to ensure that the chamfered ends of the short valve guides do not become damaged and that rotator caps are not dislodged and dropped into the engine.

To Remove Valves

- 1 Remove the rocker shaft assembly and cylinder head, see pages 5, 6 and 7.

- 2 Lay the cylinder head on a flat surface to support the valves.
- 3 Mount the valve spring compressor (tool No. TTr/D 6513) on the cylinder head and secure it with the rocker shaft support bolt nearest the valve to be removed.
- 4 Locate the foot of the tool over the valve, compress the spring, extract the collets and remove the retainer, spring and rubber seal. Repeat for all valves.
- 5 Turn the head on its side and remove the valves.

Do not stamp the heads of the valves with a centre punch, but place them with their components in a suitable container so that they may be refitted to the port from which they were removed.

VALVE GUIDES

Valve guides are serviced for both inlet and exhaust valves, and may be removed and replaced, using tool No. Tr/D 6510-AB.

If worn beyond the limits specified at the end of this section, the valve guides should be renewed.

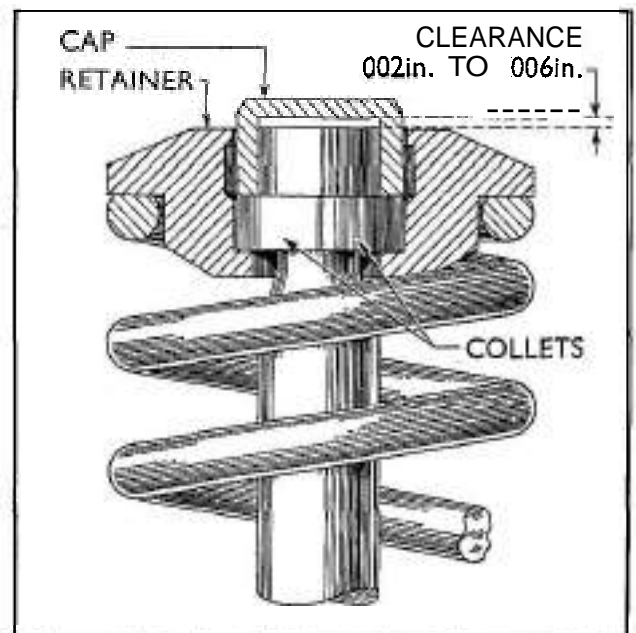

Fig. 10
Valve Cap Clearance

To Remove

- 1 Pass the rod of the valve guide remover and replacer (tool No. Tr/D 6510-AB) through the guide to be withdrawn so that the tool body abuts the valve seat, enter the spacer on the rod and screw on the retainer.
- 2 Turn the wing nut and pull the guide from the cylinder head.

The valves, springs, guides and retainers should be cleaned and the valve faces and valve seatings in the cylinder head examined for signs of pitting, burning or distortion.

To Replace

- 1 Pass the rod of the valve guide remover and replacer (tool No. Tr/D 6510-AB) through the valve guide housing so that the tool body abuts the valve seat.
- 2 Locate the guide, then the correct adaptor. (See Fig. 11.) "Code 3" is suitable for all valve guides where the head incorporates the valve spring recess. Code " Diesel Exhaust " is used for guides fitted to cylinder heads without a spring recess.

The use of the correct adaptor will ensure that the guide is correctly positioned, i.e., early type exhaust and all inlet valves 0.820-0.880 in. protrusion above the spring seat and with the short type exhaust valve guides 0.690-0.750 in.

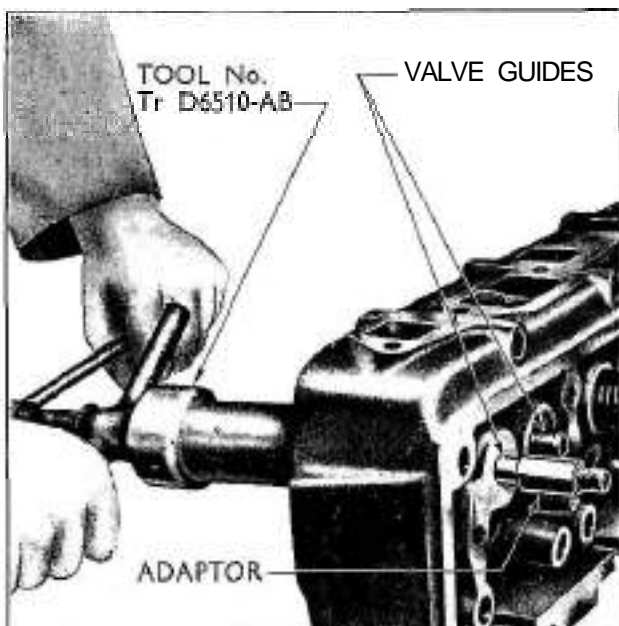

Fig. 11
Replacing the Valve Guides

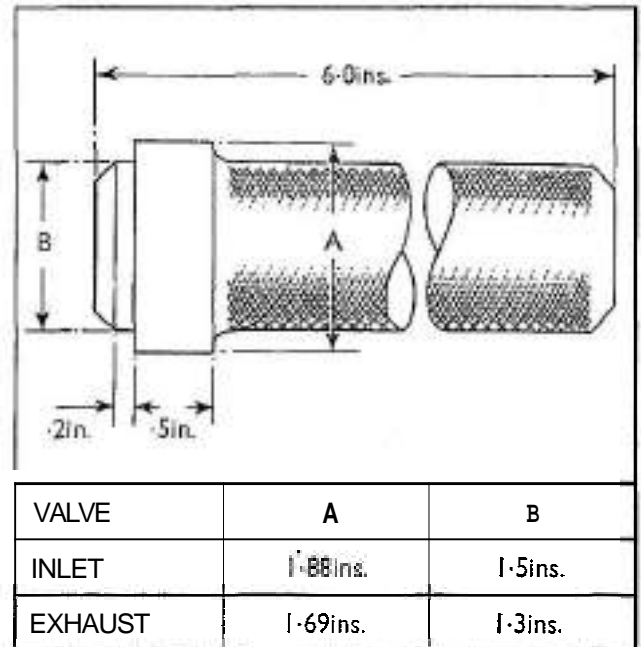

Fig. 12
Valve Seat Insert Driver

- 3 Turn the wing nut to pull the guide into its housing and continue to do so until the adaptor abuts the face of the valve spring seat on the cylinder head.

VALVE SEAT INSERTS

Where replaceable valve inserts are fitted in the cylinder head, they can be renewed, if necessary, by following the instructions given below.

The first operation is to remove the original insert and the utmost care must be taken to avoid damage to the cylinder head. The easiest method for removal is to position a bar through the insert so that the end locates under its lower inside edge, suitably protecting the edge of the head on which the fulcrum point of the bar rests. A smart tap on the outer end of the bar will force the insert out of the cylinder head.

A new insert should be placed in the recess in the cylinder head, chamfered edge first. It can then be pressed home with the aid of a driver, tool No. 6057D/19 (Inlet) and 6057D/20 (Exhaust) rings with 316-12 pilot. If not available suitable drivers can be made locally from the details given in Fig. 12. Great care should be taken to ensure that the insert is entered squarely in its recess and an extension to the driver, to locate in the valve guide, may be found advantageous.

Peening or rolling the surrounding metal of the cylinder head over the edge of the insert is unnecessary, as the

Insert	Valve	I.D. of Recess in Head	Depth of Recess in Head
Standard	Inlet	1.887"—1.888"	0.301"—0.306"
	Exhaust	1.699"—1.700"	0.301"—0.306"
.010" o/s dia. std. depth	Inlet	1.897"—1.898"	0.301"—0.306"
.010" o/s dia. and depth	Exhaust	1.709"—1.710"	0.311"—0.316"
.020" o/s dia. and depth	Exhaust	1.719"—1.720"	0.321"—0.325"

Fig. 13
Valve Seat Insert Data

interference fit is such that the insert will be firmly retained in the cylinder head.

Suitable cutters are marketed to enable the cylinder head to be machined to accept an insert where not previously fitted and also to permit an oversize insert to be fitted, should the original for any reason need renewing.

The dimensions of standard and oversize inserts can be obtained from the table shown in Fig. 13.

VALVE SEATS

If it should be necessary at any time to re-cut the valve seats in the cylinder head, one of the proprietary portable valve seat grinding machines with the stone faced to 30°, should be used.

Care should be taken when re-cutting the valve seats to ensure that too much metal is not removed. As narrow a valve seat as possible should always be maintained.

If the valve seats in the cylinder head are badly damaged, valve seat inserts should be fitted.

VALVE GRINDING

If the valve face is found to be unduly pitted or distorted, it should be refaced on a suitable valve grinding machine to an angle of 29½°. Fig. 14 shows a valve mounted in such a machine. The grinding should continue only until the face is true and free of pits, as the removal of an excessive amount of metal may thin the edge of the valve head to a degree where it will "curl" and overheat under operating conditions. For a similar reason the valve will be unduly lowered in its seating in the cylinder head and "pocketing" will result. If a valve tends towards thinness at the edge, particularly after refacing, it is more satisfactory to renew it.

If the valve seats show signs of pitting, burning or other evidence of gas leakage, they should be machined or hand ground according to their condition. Remember that hand grinding is a finishing process and on no account should excessive hand grinding be attempted, otherwise the seat angles may be altered and the seat width increased excessively. Valves which are badly burned, distorted or which have been previously ground to the limits should be discarded and new parts fitted as replacements. Always grind a replacement valve into its seating.

- 1 With the valve removed, apply a small amount of medium or fine grinding paste to the valve face and replace in correct port.
- 2 Rotate the valve lightly, using a suitable suction grinding tool, first in one direction then in the other, raising the valve off its seat from time to time and turning it approximately one-quarter of a turn to ensure a concentric seat.
- 3 Add more fine grinding paste if necessary and continue the operation until an even, clean, matt-grey finish has been obtained on a seating between $\frac{1}{16}$ in. and $\frac{3}{32}$ in. in width, keeping as near to the lower limit as possible in the case of rotator type valves. If the condition cannot be reached, it will be necessary to reface or re-cut the valves and/or seats.

After grinding-in the valves, carefully clean all paste and foreign matter from the seats and valves.

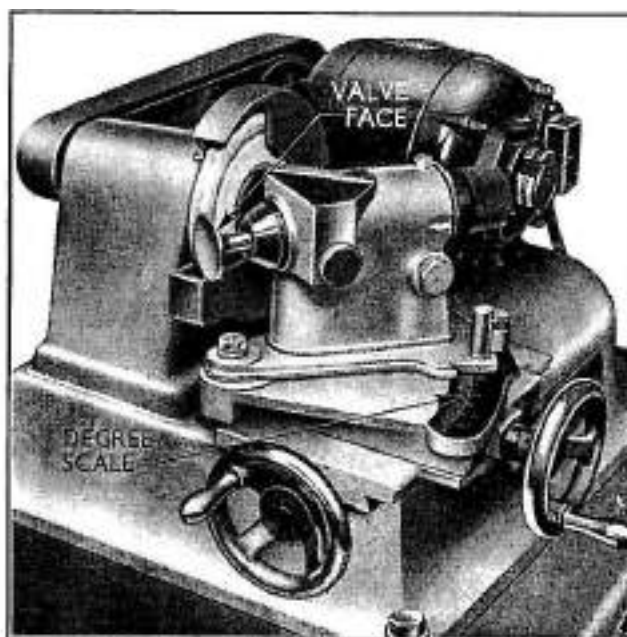

Fig. 14
Grinding the Valve Face

VALVE SPRINGS

Similar valve springs are used for the inlet and exhaust valves. They are “close-coiled” at one end to increase their efficiency and, when assembling, this end must be positioned against the valve spring seat on the cylinder head.

Before re-use all the valve springs should be carefully examined, with particular attention to squareness of ends and pressure developed at the compressed lengths.

To Replace the Valves

- 1 Remove all traces of grinding paste and foreign matter from the valve heads and stems and from the seats and guides in the cylinder head.
- 2 Oil the valve stems and guides to provide initial lubrication.
- 3 Insert each valve in its correct port.
- 4 With the cylinder head on a flat surface to support the valves, locate the valve springs in the spring retainers with the closed coils to the cylinder head.
- 5 Using the valve spring compressor (tool No. TTr/D 6513) as for dismantling, compress each valve spring in turn and fit a new rubber seal (except rotator type exhaust valves) in the lower groove in the valve stem and position the valve collets. Remove the tool.
- 6 Replace the cylinder head as described on page 7.

Adjusting the Valve Clearances

After replacing the rocker shaft assembly and push rods it will be necessary to readjust the valve clearances. With the

tappet foot on the heel of the cam the clearance between the end of the valve stem and the rocker arm should be approximately 0.015 in. measured initially for the inlet and exhaust valves without rotators. Rotator type exhaust valves should be set to 0.012 in. clearance.

After the engine has been started up the tappets should be checked and readjusted if necessary, when the engine is running at its normal working temperature.

PUSH RODS AND TAPPETS

Push rods should be checked for straightness before fitting to the engine. The tappets can only be removed from the crankcase locations after the camshaft has been withdrawn.

Note — Diesel and Vaporising Oil engine push rods are not interchangeable. (See Specification.)

DECARBONISING

It is difficult to lay down any set period when it will be necessary to carry out decarbonising a diesel engine. All other factors contributing towards loss of power, etc., such as faulty injectors and dirty air cleaners, should be checked before assuming that the cause is the need for decarbonising.

- 1 Remove the cylinder head assembly as described on page 7.
- 2 If the valves require attention, they should be removed and treated as described on pages 12 and 13.

Carbon Removal

It is essential that absolute cleanliness is observed throughout the following operations to prevent any possibility of consequential damage resulting from particles of carbon falling into the engine and causing scoring of the cylinder bores, pistons, bearings, etc.

- 1 Clean all the carbon from the face of the cylinder head and from all ports. Ensure that no burrs are made on the machined face of the cylinder head.
- 2 Apply a smear of grease inside the tops of the cylinders and rotate the engine until numbers 1 and 4 pistons are at the top of their strokes. This causes the grease to fill up the gap between the piston crown and the cylinder wall and prevents carbon particles from reaching the ring grooves and subsequently causing wear.
- 3 Cover up numbers 2 and 3 bores and all water and oil ways, using clean rag, to prevent the entry of carbon and dirt.
- 4 With a suitable scraper remove all the carbon from the piston crowns and combustion chambers, taking care not to scratch the pistons aluminium alloy.
- 5 When numbers 1 and 4 piston crowns are completely free of carbon, repeat the process of greasing on numbers 2 and 3, turn these pistons to the top of their strokes and cover up numbers 1 and 4 bores.

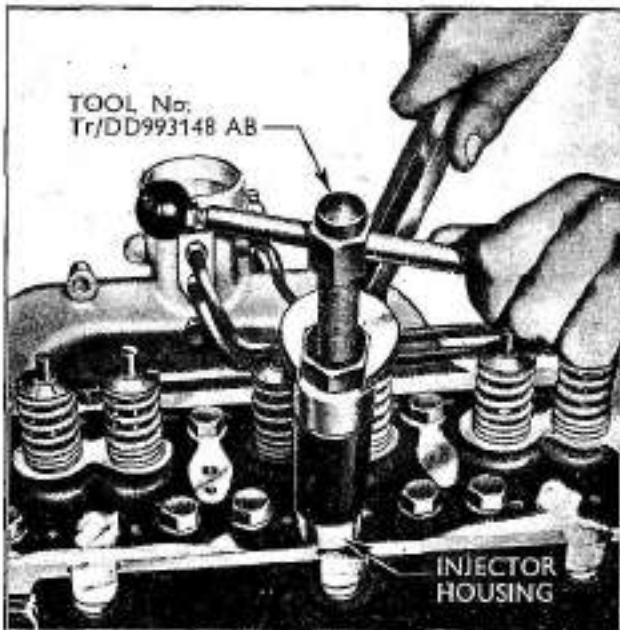

Fig. i5
Removing Injector Housing

Note — Leave the piston crowns absolutely clean and smooth, as carbon will not deposit so fast on a smooth surface, but do not use any form of abrasive, as particles may find their way into the working parts of the engine.

- 6 Clean all piston crowns and cylinder bores with a paraffin moistened non-fluffy rag, lubricate with engine oil and cover for protection until the cylinder head assembly is to be replaced.

Reassemble the valves to the cylinder head and refit the head as described in the appropriate section.

INJECTOR HOUSINGS AND SEALS

On earlier production engines, copper housings are fitted in the cylinder head, the injectors being situated in these housings.

Normally, it should not be necessary to remove the injector housings which are a light tap fit in the cylinder head.

Should it be necessary to remove any or all of these housings the remover tool (No. Tr/DD 993148-AB) should be used. New rubber seals and copper housings should always be used as replacements.

To carry out this operation there is no necessity to remove the cylinder head.

On later production diesel engines the injector housings are cast integral with the cylinder head and a plain copper washer is used to ensure a gastight joint between the injector nozzle and cylinder head.

To Remove

- 1 Drain the cooling system through the two taps, one on the radiator and one on the left-hand side of the cylinder block.
- 2 Remove the rocker cover and rocker shaft assembly as described on page 5.
- 3 Remove the injectors as described on page 91, Section Fuel System.
- 4 Place the plastic cup (part of the tool) in the base of the injector housing to prevent swarf from entering the cylinder bore.
- 5 Tap approximately four complete threads in the copper housing using the tap of tool No. Tr/DD 993148-AB.

Note — It is important that the tap is entered squarely otherwise difficulty may be experienced in removal of the housing.

- 6 Screw in the puller adaptor part of the above tool.
- 7 Screw the puller into the adaptor and locate the tubular housing of the puller against the cylinder head. (See Fig. 15.)

- 8 Screw down the top nut of the tool to withdraw the injector housing and remove the seal from its recess in the head.

To Replace

- 1 Thoroughly clean out the cylinder head location, especially the recess for the rubber seal and the lower face.
- 2 Smear a new rubber seal with soft soap, and fit it in its cylinder head location.
- 3 Enter the injector housing in its cylinder head location, and tap into position using the Replacer, part of the Removal tool, and a suitable mallet. (See Fig. 16.)
- 4 Replace the injectors as described in the Fuel System section.
- 5 Replace the rocker shaft, rocker cover and gasket as described on page 6.
- 6 Refill the cooling system.

SUMP AND GASKETS

To Remove

- 1 Remove the sump drain plug and drain off the engine oil. Replace the drain plug.

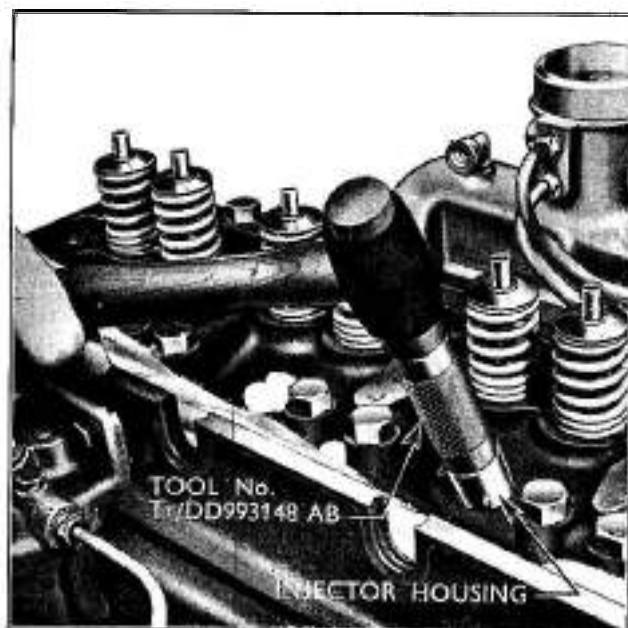

Fig. 16
Replacing Injector Housing

- 2 Remove the retaining bolts from the front ends of the radius rod.
- 3 Remove the split pin retaining the radius rod rear pin in its location and remove the radius rod rear pin.
- 4 Carefully tap the radius rod across the axle sideways until clear of the sump and then lift it away.
- 5 Disconnect the track rod end on the left-hand side of the tractor.
- 6 Remove the sump cover and the oil pump screen (six bolts).
- 7 Unscrew the bolts retaining the sump to the cylinder block and the flywheel housing. It will be necessary to support the weight of the sump as it must be lowered squarely during removal.

To Replace

- 1 Clean off the gasket faces on the sump and cylinder block.
- 2 Smear with grease and locate the new gaskets on the cylinder block faces.
- 3 Fit a cork strip to the front main bearing cap so that its ends are over the gaskets already fitted.
- 4 Fit a new lower half rear oil seal. This should be previously soaked in engine oil for one hour and when fitted should protrude at its ends $\frac{1}{32}$ in. above the sump face, in a similar manner to the upper half seal in the cylinder block (see Fig. 17).

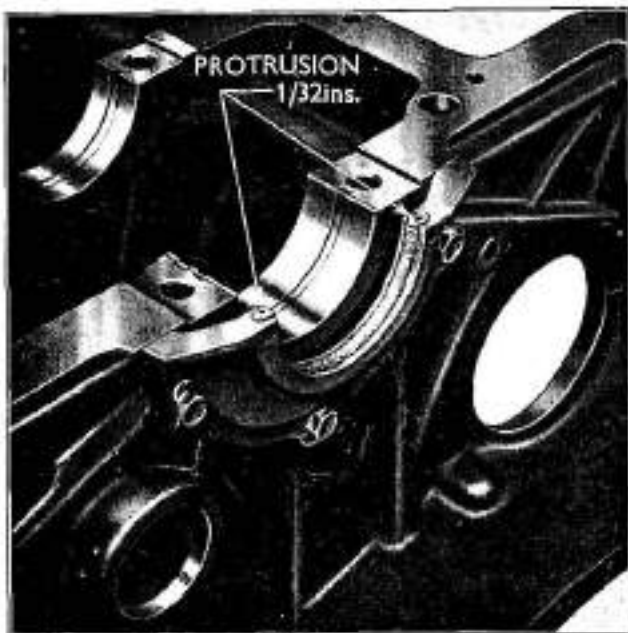

Fig. 17
Rear Main Bearing Oil Seal

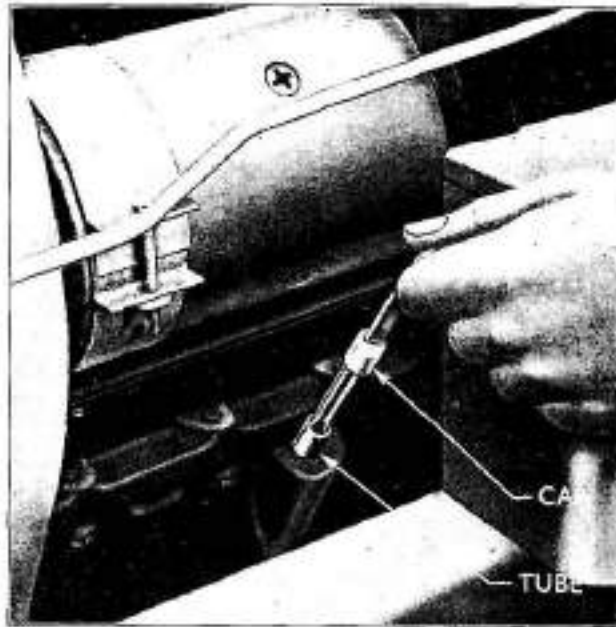

Fig. 18
Engine Oil Indicator

- 5 Replace the sump ensuring that all gaskets are correctly aligned, screw in and tighten all bolts evenly.
- 6 Reposition the radius rod and fit the two bolts in the front ends and the pin in the rear end. Do not forget the split pin.
- 7 Reconnect the track rod end on the left-hand side of the tractor.
- 8 Replace the oil pump screen, sump cover plate, gasket and drain plug.
- 9 Refill the sump with the approved grade of oil to the correct level.

Engine Oil Indicator

On current tractors the engine oil indicator is used in conjunction with a steel tube pressed into the sump. It has a metal cap secured to the shank which is located over the top of the tube. A rubber seal is fitted inside the cap to exclude all foreign matter. (See Fig. 18.)

If required in cases where early type tractors are operating under adverse conditions it is possible to convert to the latest type indicator and the following method can be adopted with the sump *in situ*.

- 1 Drain the sump and remove cover plate and oil pump screen.
- 2 Ream out the full length of the oil indicator bore in the sump to a diameter of 0.499 in. to 0.500 in. (The outside diameter of the tube is 0.5005 in. to 0.5015 in.)

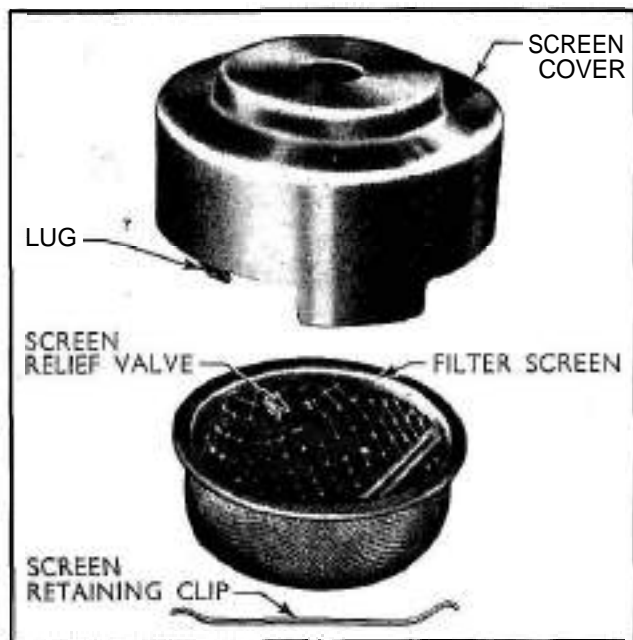

Fig. 19
Oil Pump Screen

- 3 Press the tube into the bore, taking care not to damage its upper end, until it protrudes 0.6875 in.
- 4 Clean all swarf thoroughly from inside the sump, replace the screen, and cover plate and gasket. Refill with clean oil of approved grade.

Note — The latest type oil indicator is not suitable for use on engines without the indicator tube.

THE OIL PUMP

To Clean the Filter Screen

- 1 Drain the sump and remove the cover plate (six bolts) and take out the screen.
- 2 Remove the spring clip from the screen cover and lift out the screen. (See Fig. 19.)
- 3 Wash all parts thoroughly in petrol or paraffin.
- 4 Check that the relief valve in the screen is operating freely and reassemble the screen in the cover.
- 5 Refit the oil pump screen and replace the sump cover plate and gasket. Refill the sump with clean oil of an approved grade.

To Remove the Oil Pump

- 1 Remove the sump as described on page 15.
- 2 Remove the suction pipe by removing the bolt from the support bracket on the centre main bearing cap and unscrewing the union nut after releasing the locking plate.

- 3 Unscrew the two outer bolts securing the oil pump to the cylinder block and lower it away.

Note — For Dismantling, Reassembling and Testing the Pump refer to Engine Lubrication section on pages 60 and 61.

To Replace the Oil Pump

- 1 Enter the oil pump in its block location ensuring that the oil pump upper gear engages with the auxiliary drive shaft gear and replace the two bolts securing the oil pump to the cylinder block.
- 2 Thread the suction pipe through the locking plate, screw in the union nut and secure with the tabs on the plate. Fit the support bracket to the centre main bearing cap.
- 3 Replace the sump as described on page 16 and fit the screen and sump cover plate and gasket. Refill the sump with clean oil of an approved grade.

PISTONS AND CONNECTING RODS

Numbering Connecting Rods

Connecting rods are numbered on rod and cap when installed in the engine to facilitate correct reassembly, should they be dismantled in service. (See Fig. 20.)

The numbers are stamped on the camshaft side of the big end so that a cap replaced with numbers together must be in the original position. Never reassemble the cap to the connecting rod incorrectly otherwise a true bearing surface cannot be assured.

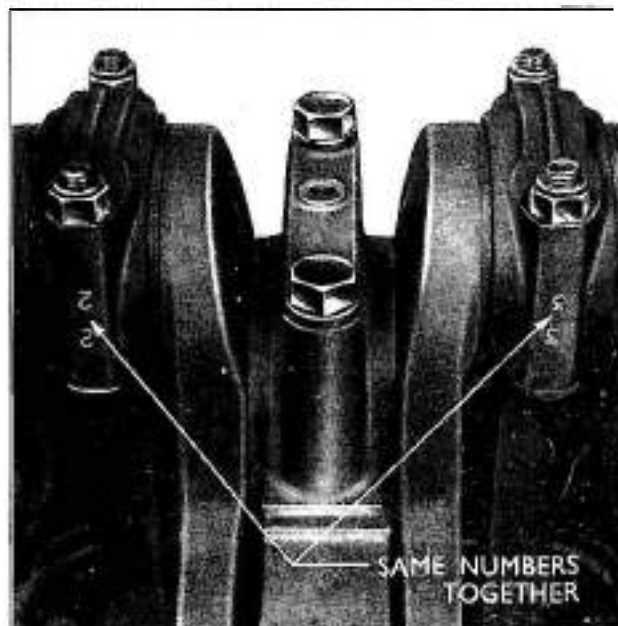

Fig. 20
Numbering Connecting Rods

It is advisable, before removing connecting rods from an engine, to ascertain that they have been numbered, as they may have been installed at some time after the engine left the factory, in which case the numbering may not have been carried out. Such connecting rods should be suitably stamped.

To Remove a Connecting Rod and Piston Assembly

- 1 Remove the cylinder head as described on page 7.
- 2 Remove the sump as described on page 15.
- 3 Remove the carbon from the top of the cylinder liner with a suitable scraper.
- 4 Turn the crankshaft so that the piston to be removed is at the bottom of its stroke.
- 5 Remove the self-locking nuts from the connecting rod bolts and remove the cap and the bottom half of the big end bearing liner.
- 6 Push the piston and connecting rod assembly up and out of the bore taking care not to dislodge the top half of the bearing liner. Keep the two halves of the big end liner in their respective positions in the rod and cap.

To Replace a Piston and Connecting Rod Assembly

- 1 Thoroughly clean out the cylinder liner with a clean dry rag.



Fig. 21
Fitting Pistons

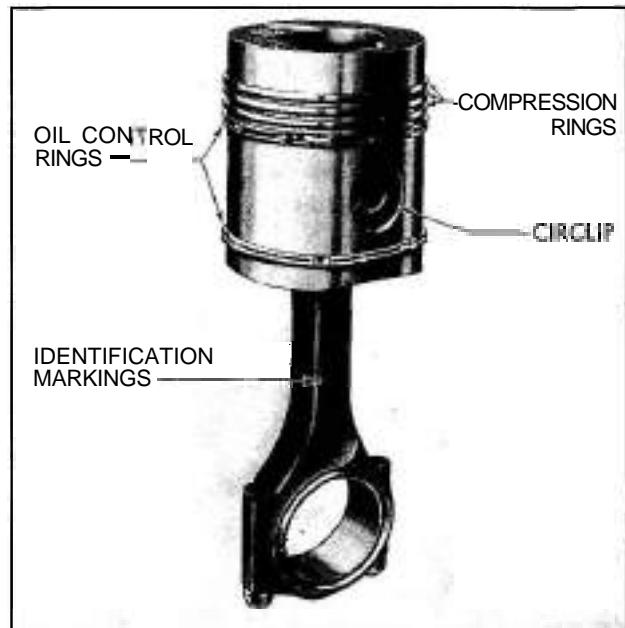

Fig. 22
Piston and Connecting Rod

- 2 Clean the piston, preferably using a compressed air line. Oil the cylinder liner piston and rings lightly.
- 3 Position the rings so that the gaps are equally spaced around the piston and no gap is in line with the piston pin bore.
- 4 Fit the top half of the bearing liner in the connecting rod, ensuring that the tongue on the liner engages in the machined recess in the big end bore, smear freely with clean oil to provide initial lubrication.
- 5 Compress the rings, using the ring compressor (tool No. TTr/DDK 6153) and insert the piston and connecting rod assembly into the bore, ensuring that the recesses for the valves are on the opposite side to the camshaft with the word "FRONT" stamped on each piston crown pointing towards the front of the engine, also check that the numbers on the connecting rod are on the same side as the camshaft.
- 6 Push the piston down the bore through the compressor. (See Fig. 21.)
- 7 Locate the lower half of the big end bearing liner in the cap with the tongue registering in the machined recess and refit the cap with the stamped numbers together and the liner smeared freely with clean oil.
- 8 Fit new self-locking nuts to the connecting rod bolts and tighten with a torque wrench to the current specification.
- 9 Refit the sump as described on page 16.
- 10 Refit the cylinder head as described on page 7.



Fig. 23
Checking Ring to Groove Clearance

PISTON RINGS

The current production ring layout is a hardened and tempered, parallel compression ring in the top groove. Two tapered compression rings are fitted in the next two grooves and it is essential that these rings are installed with the word "TOP," marked on the top face of the ring, uppermost, otherwise oil pumping may result.

Two normal slotted type oil control rings are fitted in the lower two grooves, one immediately above and one below the piston pin. (See Fig. 22.)

Only this ring combination should be used in service.

To Remove

- 1 Remove the connecting rod and piston assembly as described previously, and turn the piston rings in their grooves until the five gaps are in line.
- 2 With the piston laid on a flat surface, rings downwards, push three metal strips (0.020 in. feeler strip not more than $\frac{1}{8}$ in. wide is suitable) through the gaps between the piston and ring. Work two of the strips sideways until the three strips are equally spaced around the piston. The rings can then be eased over the metal strips.

Checking Piston Ring Gap

- 1 Insert the piston ring in the cylinder bore, centralising it by means of a piston until the ring is on an unworn part of the bore. The gap should then be checked by means of a feeler gauge to ensure that it is within the specified limits.
- 2 Check that the piston ring grooves are clean, especially the oil control ring grooves, and ensure that the oil return holes are clear.

With the piston ring inserted in its groove (see Fig. 23), check that the piston ring to groove clearance is within the specified limits.

Insufficient clearance may cause piston ring seizure, resulting in loss of compression. Excessive clearance will contribute to oil pumping.

To Replace

- 1 Replace the piston rings, oil control rings first, in their respective grooves. The hardened and tempered parallel faced compression ring must be fitted in the top groove and the lower taper faced compression rings with the word "TOP" uppermost.
- 2 Position the piston ring gaps so that they are evenly spaced as described on page 18. Lubricate the cylinder liner, piston and rings.
- 3 Replace the piston and connecting rod assembly as described on page 18.

PISTONS

The pistons are of aluminium alloy with solid skirts and a combustion chamber and two recesses for the valves machined in the crowns.

If new pistons are being installed they should be selected to fit in the cylinder liners, using a poundage pull gauge (tool No. 512) in conjunction with a strip of feeler steel, 9 ins. long, having a width and thickness as specified. The feeler should be inserted into the cylinder at right angles to the piston pin for the whole length of the piston and a pull of between four and seven pounds should be required to remove it, see Fig. 24.

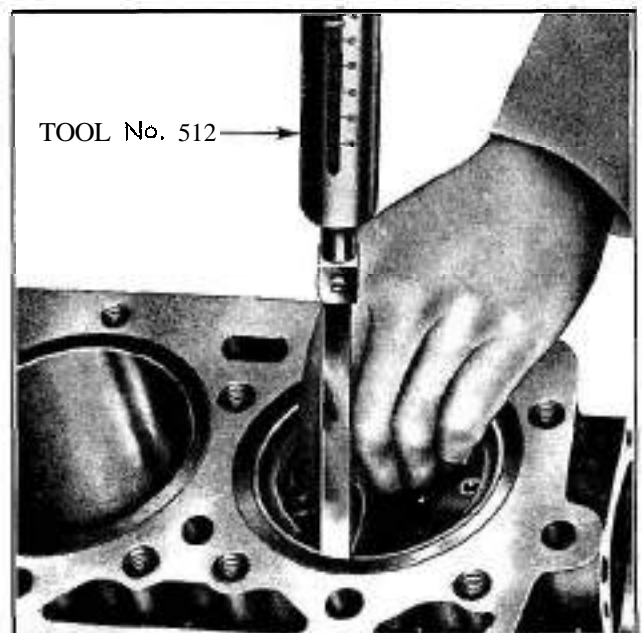

Fig. 24
Checking Fit of Piston in Bore

The only oversize pistons available for service are plus 0.0025 in.

To Remove a Piston from a Connecting Rod

- 1 Remove the connecting rod and piston assembly as described on page 18.
- 2 Remove the two circlips, retaining the piston pin in the piston. To assist in removing the piston pin the piston may be warmed by insertion in boiling water.
- 3 Push out the piston pin.

To Replace a Piston on Connecting Rod

- 1 Heat the piston in boiling water to allow easy assembly of the piston pin.
- 2 Insert the connecting rod between the piston bosses so that the number on the connecting rod is on the opposite side to the recesses for the valves.
- 3 Insert the piston pin and fit the circlip retainers in the grooves at each end.
- 4 Oil the parts and reassemble as described on page 18.

PISTON PINS

The piston pin fitted to the Diesel engine is of the heavy type to accommodate the higher stresses imposed and for this reason it is essential that only the correct part is fitted.

It is advisable, therefore, to warm the piston before removing or replacing the piston pin which is retained by means of a circlip installed in a groove at each end of the piston pin bore.

Piston pins are not interchangeable on the diesel, petrol or vaporising oil engines. (See Specification.)



Fig. 25
Checking Connecting Rod End-float

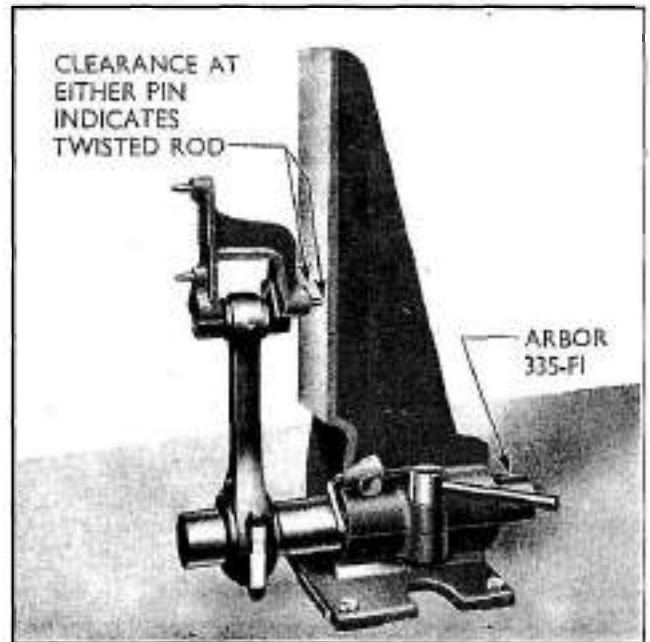

Fig. 26
Checking for Twisted Connecting Rods

CONNECTING RODS

The connecting rods are forgings of “H” section having steel backed, lead bronze, indium plated big end bearing liners and separate bolts and self-locking nuts. The piston pins are fully floating and the small end of the connecting rod is bronze bushed.

The connecting rods in the diesel engine are heavier than those in the petrol and vaporising oil engines, and can be identified by the word “DIESEL” embossed on the centre web.

The small end bushes are not serviced independently.

Renewing Connecting Rod Liners

Liners may be changed without removing the piston and connecting rod assembly from the engine.

Connecting rod liners are available in standard and 0.010 in., 0.020 in., 0.030 in. and 0.040 in. undersize.

- 1 Remove the sump as described on page 15.
- 2 Remove the oil pump suction pipe as described on page 17.
- 3 Turn the crankshaft to bring the affected big end to bottom dead centre. Remove the self-locking nuts and detach the cap.
- 4 Push up the connecting rod sufficiently to clear the crankpin and move the big end to one side. The upper half of the liner may now be extracted from the rod and a new one inserted with the tongue in the liner engaging the machined recess in the big end bore.
- 5 The lower half of the liner may now be extracted from the cap and a new one inserted as described for the upper half in paragraph 4.

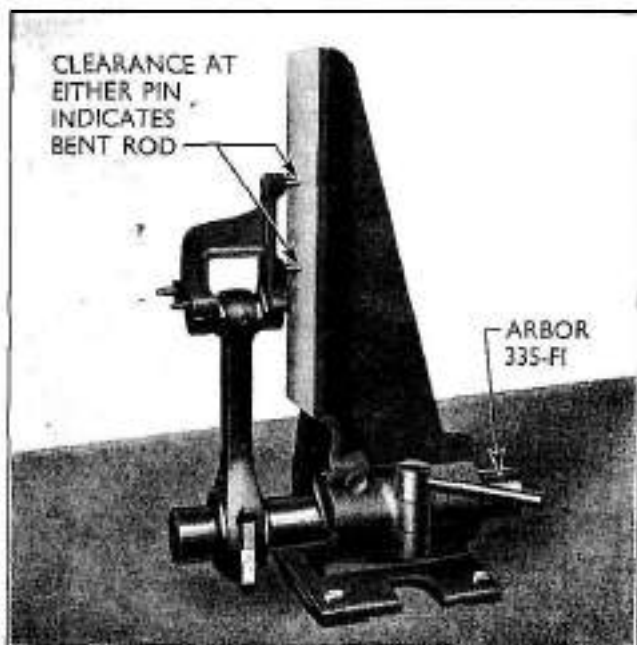

Fig. 27

Checking for Bent Connecting Rods

- 6 Lubricate the liner and refit the big end to the crankpin, taking care that the upper half of the liner is not dislodged.
- 7 Replace the big end cap with the stamped numbers together (ensure that the cap bolts are right down with the bolt heads locating against the sides of the rod).
- 8 Fit new locknuts and tighten to the specified torque and check the end-float by means of a feeler gauge as shown in Fig. 25.
- 9 Replace oil pump suction pipe and sump as described on page 17.
- 10 Replace the oil screen, sump cover plate and gasket and radius rod, etc., as described on page 17.

CONNECTING ROD ALIGNMENT

Connecting rod alignment can be checked by using the connecting rod alignment jig, tool No. 335 and arbor No. 335-F1. This indicates bent or twisted connecting rods, see Figs. 26 and 27. The method of testing is described below.

Checking for Twisted Connecting Rods

- 1 Remove the piston as described on page 20. Insert the piston pin in the small end of the connecting rod, in which it must be a good fit, otherwise misleading results will occur.
- 2 Bolt the connecting rod, without bearing liners, to the arbor and with the gauge mounted on the piston pin with the two horizontal pins towards the jig, move the arbor along until the pins touch the machined surface. Clamp the arbor in this position. Clearance between the face of the jig and one of the pins, indicates a twist in the connecting rod (see Fig. 26).

Checking for Bent Connecting Rods

The procedure is the same as for checking for twisted connecting rods, except that the vertical pins of the gauge are brought into contact with the machined surface (see Fig. 27). Clearance between one of the pins and the machined face of the jig indicates small and big end bores are out of parallel and the connecting rod is bent.

Where any connecting rods are found to be either twisted or bent, they should be replaced. No attempt should be made to straighten these connecting rods.

CYLINDERS LINERS

The diesel engine is fitted with detachable wet cylinder liners, flange-mounted in the top face of the cylinder block and retained in position by the cylinder head. A rubber seal is situated around the bottom of the cylinder liner to make a water-tight joint. (See Fig. 28.)

When fitting new liners to a block, it is essential that the liner protrusion above the block face is between 0.002 in. and 0.004 in. The most satisfactory method of checking this protrusion is by using a straight edge and feelers. In the event of difficulty in obtaining this protrusion, it is possible to use shims under the liner flange to bring it within the above limits.

These shims are supplied for service in 0.002 in. and 0.003 in. thicknesses.

When checking this protrusion it is also necessary to carry out the check in more than one position to ensure that the top flange of the cylinder liner is parallel with the top face of the cylinder block. Should the flange be more than 0.002 in. out of parallel with the top face of the cylinder block it is advisable to turn the cylinder liner and recheck to see if an

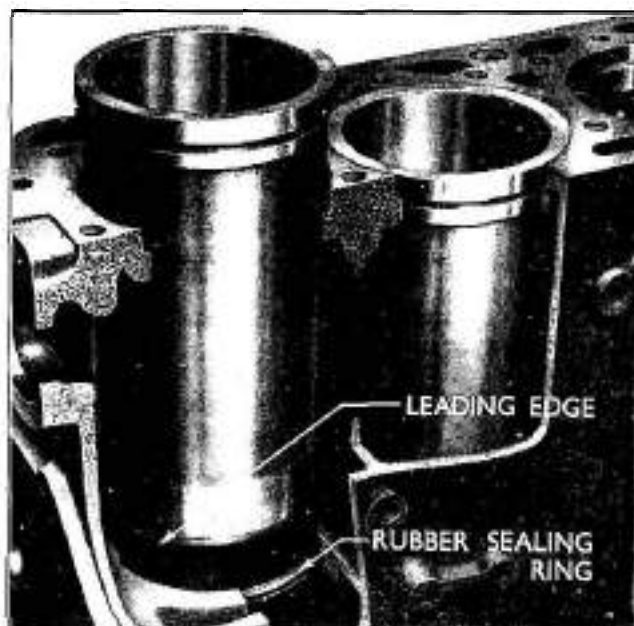

Fig. 28
Cylinder Liner

improvement can be made. Failing this it is advisable to interchange the cylinder liners with the cylinder block locations until it is possible to get all four liners within the 0.002 in. limit. (See Fig. 30.)

To Remove the Cylinder Liners

- 1 Remove the cylinder head as described on page 7.
- 2 Remove the sump and radius rod as described on page 15.
- 3 Remove the connecting rods and piston assemblies as described on page 18.
- 4 Withdraw the liners, using the extractor (tool No. TTr D 6055-A—see Fig. 29), and remove the seals from their recesses in the block. If original liners are to be refitted, number and mark them for angular position. Do not make this mark on the top face of the flange.

To Replace Cylinder Liners

- 1 Ensure that the recesses for the seals in the cylinder block and the liner flange location are clean and free from loose particles of dirt and carbon.
- 2 Fit the liners in their location *without the* rubber seals and check that the liner protrusion above the top face of the cylinder block is between 0.002 in. and 0.004 in. and that they are parallel within 0.002 in. Carry out this test with the straight edge in more than one position. (See Fig. 30.)
- 3 Remove the liners after this check, lubricate the rubbers seals with soft soap and fit them in their recesses in the block.
- 4 Fit the cylinder liners by hand, rotating them slowly in a short arc and making sure that the liner seal is not disturbed from its location.

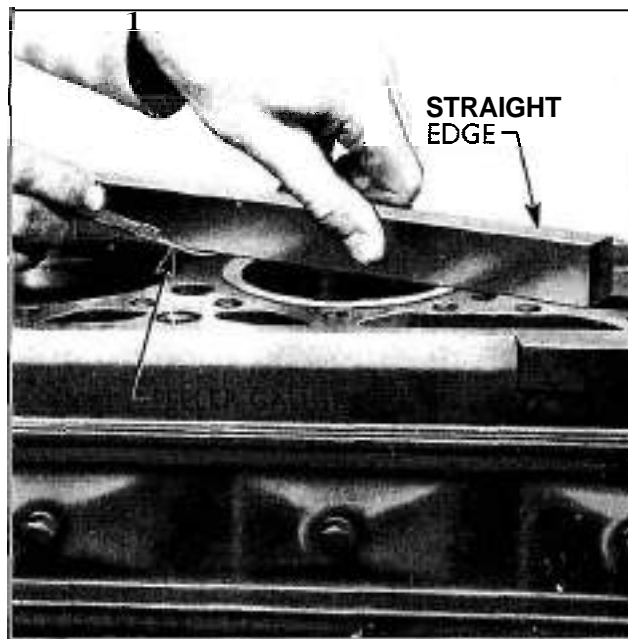

Fig. 30
Checking Liner Protrusion

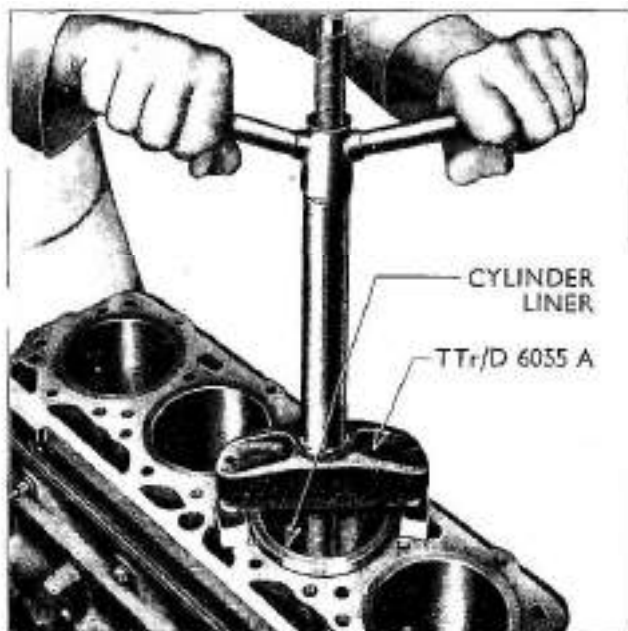

Fig. 29
Removing a Cylinder Liner

- 5 Refit the connecting rod and piston assemblies as described on page 19.
- 6 Refit the sump and radius rod as described on page 16.
- 7 Refit the cylinder head as described on page 7.

THE TIMING COVER AND OIL SEAL

To Remove

- 1 Drain the cooling system through the two taps, one on the radiator and one on the side of the cylinder block.
- 2 Remove the engine bonnet by unscrewing the two screws from the rear clip. If pre-filter is fitted above the bonnet remove it first.
- 3 Disconnect the top and bottom water hoses by unscrewing the clips on the radiator end of the hoses.
- 4 Disconnect the headlamp wiring by pulling out the snap connectors at the right-hand side of the tractor, near the radiator.
- 5 Remove the radiator tie bar clip from the water outlet connection bolt.
- 6 Disconnect the radiator shutter operating rod at the radiator end behind the grille.
- 7 When a horizontal exhaust system is fitted, remove the bolt securing the silencer to the side channel.
- 8 Mount the front axle wedge tool No. Tr2/NMD 3004.
- 9 Remove the cotter pin from the radius rod rear pin and pull out the pin.
- 10 Remove the two bolts from the fork ends of the radius rod.



Fig. 31
Removing Crankshaft Pulley

- 11 Carefully tap the radius rod sideways across the front axle until clear of the sump and lift it away.
- 12 Disconnect the steering drag link by unlocking the drag link front ball plug and unscrewing the plug.
- 13 If the tractor dismantling stand Tr/NMD 27 is not available, suitably support the engine.
- 14 Remove the ~~four~~ bolts from each side channel where the side channel is bolted to the gearbox.
- 15 Remove the three bolts from each side channel, securing the front mounting plate to the side channel.
- 16 Support the radiator and front axle assembly by the side channels and wheel the assembly forward until clear of the tractor,
- 17 Slacken off and remove the generator and fan belt.
- 18 Remove the crankshaft ratchet and pulley using the turning bar (tool No. TTr/D 6319) to undo the crankshaft ratchet and puller (tool No. TTr/D 6312-A) to withdraw the pulley. (See Fig. 31.)
- 19 Remove the timing cover (fourteen bolts). Take care not to damage the seal when the cover is withdrawn.

To Renew the crankshaft Front Oil Seal in Timing Cover

- 1 Carefully extract the old seal with a suitable lever.
- 2 Locate a new seal in the front cover with the lip of the seal towards the inside of the cover.
- 3 Tap the new seal gently into position using the tool No. TTr/D 6362-B and a suitable mallet. (See Fig. 32.)

To Replace the Timing Cover

- 1 Locate the cover and new gasket on the front face of the mounting plate. On earlier tractors where the front mounting plate is not dowelled, fit the crankshaft pulley to align the timing cover oil seal with the crankshaft.
- 2 Screw in the fourteen bolts to secure the cover. Make sure that the coarse threaded bolts are screwed into the block, and the fine threaded ones into the front mounting plate and tighten evenly to the specified torque.
- 3 Fit the crankshaft pulley and ratchet.
- 4 Replace the generator and fan belt, adjust to give a belt free movement of $\frac{1}{2}$ in. (12.6 mm.) midway between water pump and generator pulleys, and tighten up the generator mounting bolts.
- 5 Support the radiator and front axle assembly by the side channels and wheel it towards the tractor, positioning the front mounting plate in ~~each~~ side channel, until the holes in the end of each side channel are located opposite ~~their~~ gearbox mounting positions. Refit the four bolts securing each side channel to the gearbox mountings and replace the six bolts retaining the front mounting plate to the channels.
- 6 Release the weight of the engine from the lifting equipment used.
- 7 Reconnect the steering drag link.
- 8 Position the radius rod with the fork ends on the front axle to the right-hand side of their location holes and gently rap the radius rod across the front axle, at the same time locating its rear end in the sump bracket.

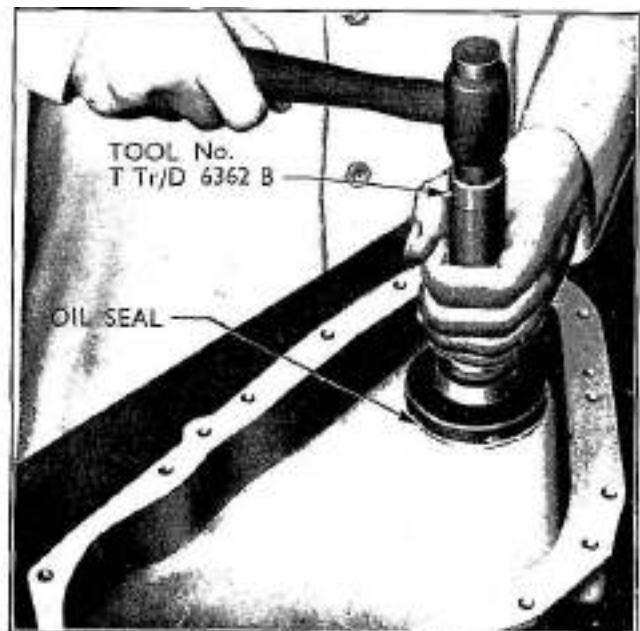

Fig. 32
Fitting Crankshaft Oil Seal in Timing Cover

- 9 Replace the two bolts in the fork ends of the radius rod.
- 10 Refit the radius rod rear pin and secure it with the cotter pin, then remove the front axle wedge (tool No. Tr2/NMD 3004.)
- 11 If a horizontal exhaust system is fitted, replace the bolts securing the silencer to the left-hand side channel.
- 12 Reconnect the radiator shutter operating rod at the radiator end.
- 13 Refit the radiator tie bar clip to the water outlet connection bolt.
- 14 Reconnect the headlamp wiring by pushing in the snap connectors on the right-hand side of the tractor near the radiator.
- 15 Replace the top and bottom radiator water hoses and tighten up the clips.
- 16 Replace the engine bonnet and secure it by screwing in the two screws in the rear clip. If a vertical primary air cleaner is fitted, replace this now.
- 17 Refill the cooling system.

TIMING GEARS

The camshaft and auxiliary drive shaft are driven from the crankshaft by helical gears. Should they at any time be disturbed the timing gears are suitably marked to facilitate **re-timing** and the marks are all relative to top dead centre compression stroke, No. 1 cylinder. (See Fig. 33.)

To Check the Timing Gear Backlash

- 1 Remove the timing cover as described on page 22.

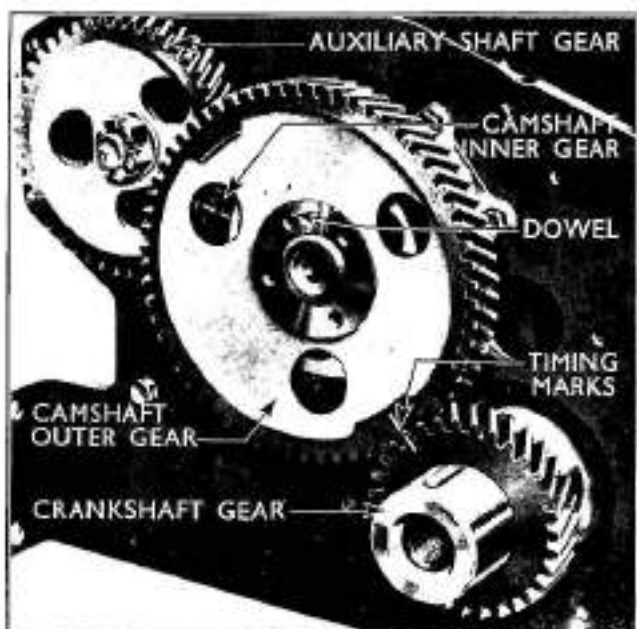

Fig. 33

Camshaft and Crankshaft Timing Gears

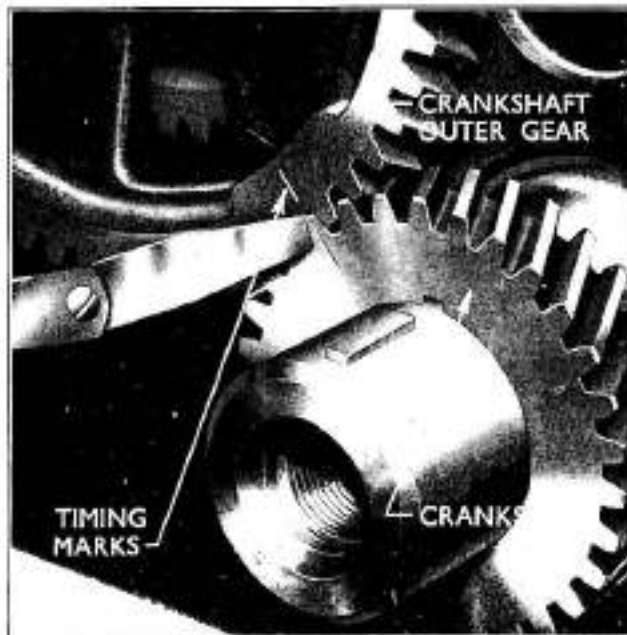

Fig. 34

Checking Timing Gear Backlash

- 2 Check the backlash between the gears using a suitable feeler gauge. This should be between 0.003 in. and 0.004 in. (See Figs. 33 and 34.)
- 3 Replace the timing cover as described on page 23.

To Remove the Timing Gears

- 1 Remove the timing cover as described on page 22.
- 2 Turn the crankshaft until the marked teeth on the crankshaft gear and camshaft outer gear are in line.
- 3 Remove the split pin from the auxiliary drive shaft castellated nut and unscrew the nut.
- 4 Bend back the locking tabs of the three bolts securing the camshaft gears to the camshaft, remove the bolts and the camshaft outer gear.
- 5 Remove the auxiliary drive shaft gear and camshaft inner gear.
- 6 Remove the crankshaft gear, using the puller (tool No. ATTr/NVMD 6306-A) with the thrust button inserted in the threaded end of the crankshaft (see Fig. 35).

Note — Once the gears have been removed do not rotate the engine otherwise interference may occur between the fuel lift pump eccentric on the camshaft and a big end nut on No. 4 connecting rod.

To Replace the Timing Gears

- 1 Refit the crankshaft gear, using tool No. Tr2/D 6306-B. Take care that the marked side of the gear is to the front and that the keyway is located over the crankshaft keys. On current engines a long single key is fitted.
- 2 Refit the camshaft inner gear making sure that the camshaft dowel is in position.

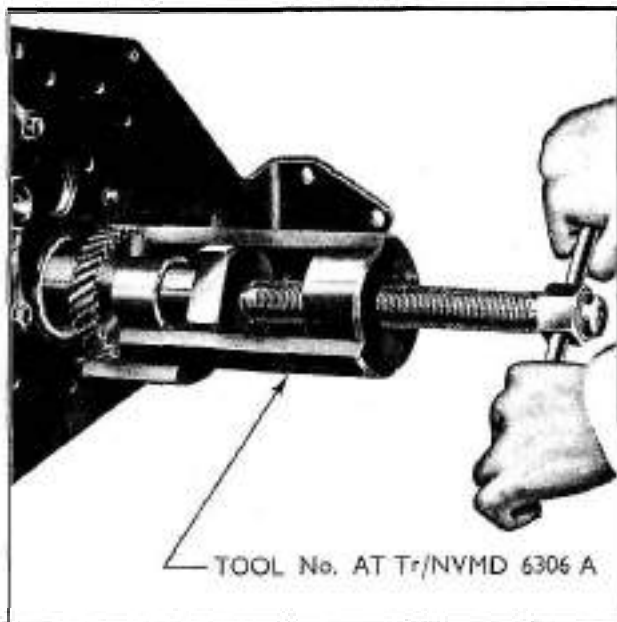

Fig. 35
Removing Crankshaft Gear

- 3 Replace the auxiliary drive shaft gear making sure that its timing mark is in line with that on the camshaft inner gear. (See Fig. 33.)
- 4 Fit the camshaft outer gear with its timing mark in line with the mark on the crankshaft gear. Fit the lock plate and replace the three bolts. Bend up the corners of the lock plate to secure the bolts. Fit the auxiliary drive shaft castellated nut and lock by means of a new split pin.
- 5 Replace the timing cover, etc., as described on page 23.

FRONT MOUNTING PLATE

Current production tractors are now fitted with a modified engine front mounting plate incorporating two stepped dowels and one extra bolt as shown in Fig. 36.

In service the extra bolt can be easily installed in engines not so equipped, by drilling and tapping a $\frac{1}{8}$ in. 18NC2 hole in the block. The hole must be $\frac{1}{8}$ in. deep and the thread $\frac{1}{8}$ in. deep. A suitable template to locate the position of the hole can be provided by using a current type engine front mounting plate gasket.

It is not considered practicable in service to modify the block and mounting plate to accommodate the two stepped dowels on tractors nor so equipped.

Where the original mounting plate is not drilled to accommodate the bolt, it can be reworked using the latest type mounting plate gasket as a template.

Current type mounting plates and engine timing covers can be used on earlier type engines, drilling the extra bolt hole in the block, if necessary.

Current type blocks (with dowels) can be used with earlier type mounting plates and front covers by removing the dowels from the blocks, although if a new cylinder block is supplied, it is preferable to fit the latest type mounting plate and timing cover.

To Remove

- 1 Remove the timing cover and timing gears as described on pages 22 and 24.
- 2 Bend back the locking tabs and remove the retaining screws. Remove the screws to release the generator bracket and timing pointer, and then lift off the front mounting plate and gasket.

The oil relief valve may now be removed if necessary. See Engine Lubrication section.

To Replace

- 1 If the oil relief valve has been removed, refit it to the mounting plate.
- Instal the mounting plate and gasket, generator bracket and timing pointer and bend up the locking tabs of the retaining bolts.
- 2 Instal the timing gears and timing cover as described on page 24.

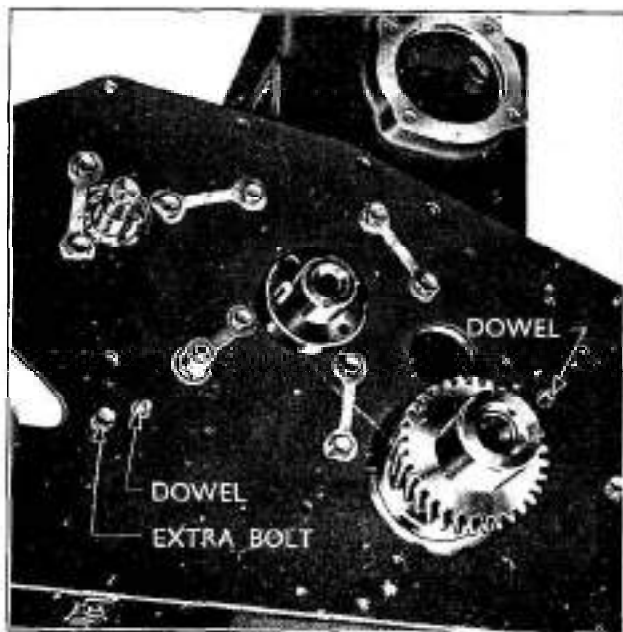

Fig. 30
Modified Front Mounting Plate

THE AUXILIARY DRIVE SHAFT

The auxiliary drive shaft is driven from the camshaft by helical gears and is used in the Diesel engine to drive the Fuel Injection Pump and the Oil Pump.

To Renew the Auxiliary Drive Shaft Oil Seal without Removing the Shaft

- 1 Remove the fuel injection pump as described in the Fuel System Section of this Manual.
- 2 Remove the fuel injection pump coupling by removing the clamp bolt and tapping the coupling rearwards off its shaft.
- 3 Remove the coupling key from the auxiliary drive shaft.
- 4 Remove the oil seal by carefully splitting the metal casing with a suitable small chisel and gripping with a pair of pliers.
- 5 Clean out the recess for the seal, check the shaft and key for burrs which must be removed, and screw the oil seal guide (tool No. Tr2/DD 66610-B) in to the end of the shaft.
- 6 Carefully fit the seal over the guide, on to the shaft (see Fig. 37), and gently drive it into place using the replacer (part of the above tool) and a suitable mallet.
- 7 Refit the auxiliary drive shaft key.
- 8 Refit the coupling and the fuel injection pump as described in the Fuel System Section.

To Remove the Auxiliary Drive Shaft

- 1 Drain the cooling system and remove a battery lead.

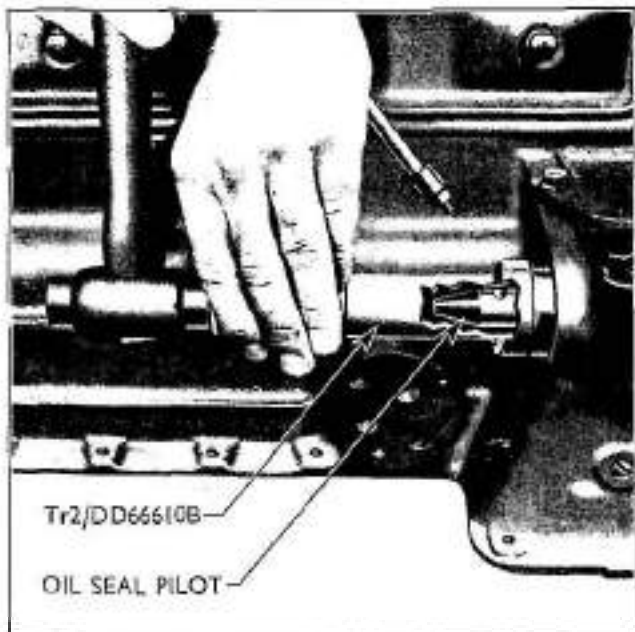

Fig. 37
Replacing Auxiliary Drive Shaft Oil Seal

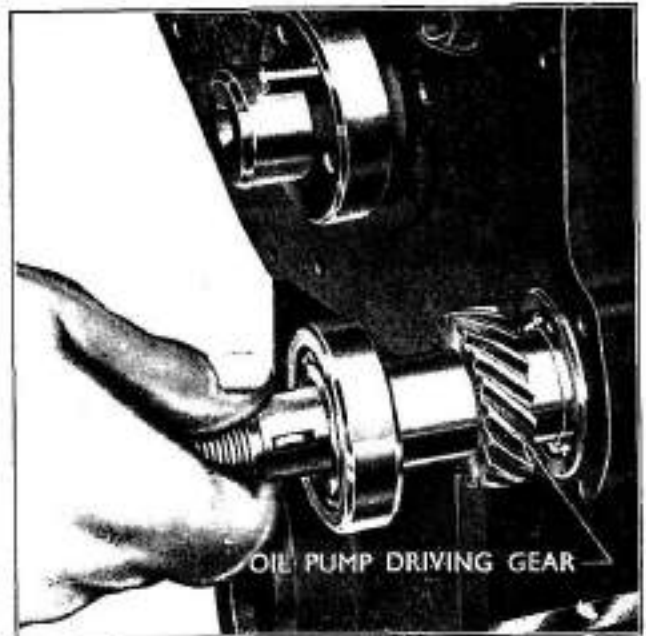

Fig. 38
Replacing Auxiliary Drive Shaft

- 2 Remove the radiator and front axle assembly as described in the appropriate sections.
- 3 Drain the engine oil and remove the sump, gasket and oil pump.
- 4 Remove the engine timing cover and gasket as described on page 22.
- 5 Remove the camshaft and auxiliary drive gears as described in the section on this subject. It is not necessary to remove the crankshaft gear.
- 6 Remove the front mounting plate and gasket by unscrewing the retaining bolts, see page 25.
- 7 Remove the fuel injection pump as described in the Fuel System Section.
- 8 Remove the fuel injection pump coupling by removing the clamp bolt, extracting the key and tapping it rearwards.
- 9 Tap the auxiliary drive shaft forward out of its block location, complete with bearings.
- 10 Extract the bearings using the puller (tool No. TTr/D 66608-AB).
- 11 Remove the auxiliary drive shaft oil seal by tapping it rearwards out of the block and then remove the circlip from its groove.

To Replace the Auxiliary Drive Shaft and Oil Seal

- 1 Locate the circlip retainer for the auxiliary drive shaft oil seal in its groove in the cylinder block.
- 2 Refit the bearings to the auxiliary drive shaft, using tool No. TTr/D 66608-AB.

- 3 Enter the shaft from the front of the block and tap it rearwards until the front bearing is flush with the front face of the block. (See Fig. 38.)
- 4 Refit the front mounting plate and gasket. (See page 25.)
- 5 Fit the camshaft inner gear, auxiliary drive shaft gear and camshaft outer gear, making sure that the timing marks are in line.
- 6 Refit the timing cover and gasket as described on page 23.
- 7 Refit the crankshaft pulley and ratchet.
- 8 Screw the guide for the auxiliary drive shaft oil seal (tool No. Tr2/DD 66610-B) into the end of the drive shaft.
- 9 Fit a new oil seal and tap into position using the replacer (tool No. Tr2/DD 66610-B).
- 10 Remove the guide from the shaft and refit the fuel injection pump coupling key and the coupling.
- 11 Replace the fuel injection pump as described in the Fuel System section.
- 12 Replace the oil pump and suction pipe. (See page 17.)
- 13 Refit the engine sump and gaskets. (See page 16.)
- 14 Refit the radiator and front axle assembly as described in the appropriate sections.
- 15 Reconnect the battery lead and fill the cooling system.
- 16 Refill the engine sump with the approved grade of oil to the correct level.

CAMSHAFT AND TAPPETS

Camshaft end-float is controlled by a split type thrust plate located in a groove machined in the hub of the camshaft and a recess in the front face of the block. The top half of this plate is dowelled to prevent rotation and held in position by the front mounting plate.

The camshaft runs in cast iron bearings machined directly in the block and fed with oil from the adjacent main bearings.

To Remove

- 1 Drain the cooling system through the two taps provided.
- 2 Disconnect the fuel pipes and remove the fuel lift pump as described in the Fuel System section.
- 3 Remove the rocker cover, rocker shaft and push rods as described on page 5.
- 4 Remove the front axle and radiator assembly and timing cover as described in the appropriate sections.
- 5 Remove the camshaft outer gear, auxiliary drive shaft gear, and camshaft inner gear as described on page 24.
- 6 Bend back the lock plates of the front mounting plate retaining bolts and unscrew the bolts. Lift off the front mounting plate complete with the oil pressure relief valve and remove the mounting plate gasket.

- 7 Remove the tappet side cover and hold up the tappets in their locations, using suitable clips.
- 8 Pull the camshaft forward slightly and lift out the two halves of the thrust plate.
- 9 Carefully withdraw the camshaft. Rotating it slowly will assist this operation.
- 10 If desired the tappets may now be extracted from underneath after the sump has been drained and removed.

To Replace

- 1 Lubricate the tappets and refit them in their locations. Use suitable clips to hold the tappets up while the camshaft is replaced.
- 2 Check the camshaft endfloat, using a feeler gauge, by fitting the thrust plate into its groove in the camshaft before the camshaft is fitted to the engine. The clearance should be between the limits specified at the end of this section.
- 3 Lubricate the camshaft journals and slide the camshaft into its bearings, being careful not to damage the edges of the cams or bearings.
- 4 Before the camshaft is pushed fully home, fit the camshaft thrust plate in its groove and as the camshaft is pushed home, ensure that the dowel in the upper half of the thrust plate enters the hole in the block. (See Fig. 39.)
- 5 Fit a new front mounting plate gasket and the mounting plate.
- 6 Replace the timing gears and the timing cover as described on page 24.



Fig. 39
Camshaft Thrust Washers

- 7 Replace the push rods, rocker shaft and rocker cover as described on page 6. Instal the tappet side cover and gasket.
- 8 Refit the fuel lift pump and connect up the fuel pipes. (See Fuel System section.)
- 9 Refit the sump, if removed, and replace the radiator and front axle assembly as described in the appropriate sections.
- 10 Refill the cooling system with clean soft water.
- 11 Refill the engine sump with the correct grade of oil if the original was drained.

MAIN BEARING LINERS

The main bearings are detachable steel backed, lead bronze, indium plated liners and these may be easily replaced without the necessity for removing the engine.

They are held in position by tongues which register with suitable locations in the cylinder block and cap, to prevent them from turning or moving out of position.

In service, liners are supplied 0.010 in., 0.020 in., 0.030 in. and 0.040 in. undersize in the bore.

Should it be necessary to renew crankshaft main bearings following failure due to oil shortage, it is imperative that all oilways and the oil pump are thoroughly cleaned, otherwise mere replacement of liners may lead to repeated failure. In this event the engine must be removed.

Crankshaft End-Float

The crankshaft end-float is controlled by detachable thrust washers at each side of the centre main bearing. The



Fig. 40
Crankshaft Thrust Washers

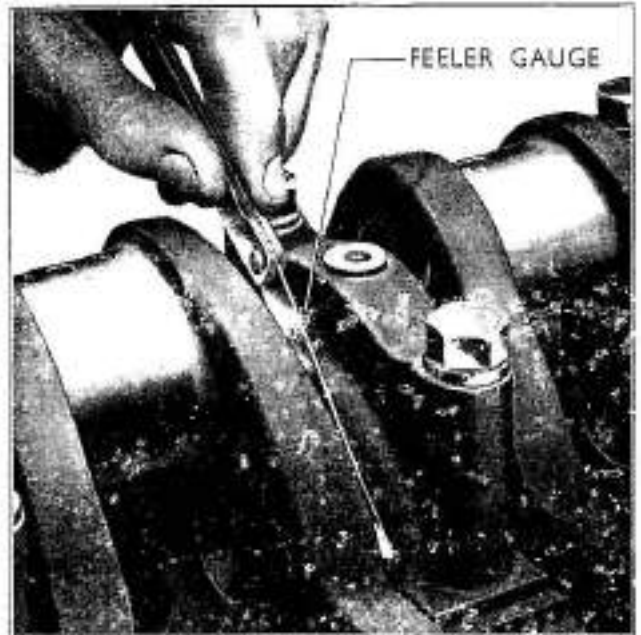

Fig. 41
Checking Crankshaft End-float

lower halves of these thrust washers have suitable locating lugs to prevent them from turning out of position. Fit the crankshaft thrust washers in the recesses at each side of the centre main bearing with their oil grooves outwards. (See Fig. 40.)

The thrust washers are available in service in 0.0025 in., 0.005 in., 0.0075 in. and 0.010 in. oversize in thickness.

To check the crankshaft end-float, carefully push the crankshaft endwise as far as it will go, and test with a feeler gauge the gap between the machined shoulder on the crankshaft web and the crankshaft thrust washers. (See Fig. 41.)

End-float should be within the specified limits. If the end-float is too great the centre main bearing cap should be removed and the appropriate oversize thrust washers fitted.

To Renew Main Bearing Liners

- 1 Remove the sump and oil pump suction pipe as described on page 17. Even if it is necessary to renew all the main bearing liners, remove only one bearing cap at a time.
- 2 Remove the cap from the bearing affected or, if all bearing liners are to be changed, commence at No. 1 main bearing, taking care not to disturb the front mounting plate gasket when removing the cap. Turn the crankshaft until the oil hole in the exposed journal is near the end of the liner opposite the tongued side.
- 3 Insert the special liner pin, tool No. TTr/D 6331-AB, in the oil hole in the crankshaft journal, so that the head of the pin lies flat against the journal.

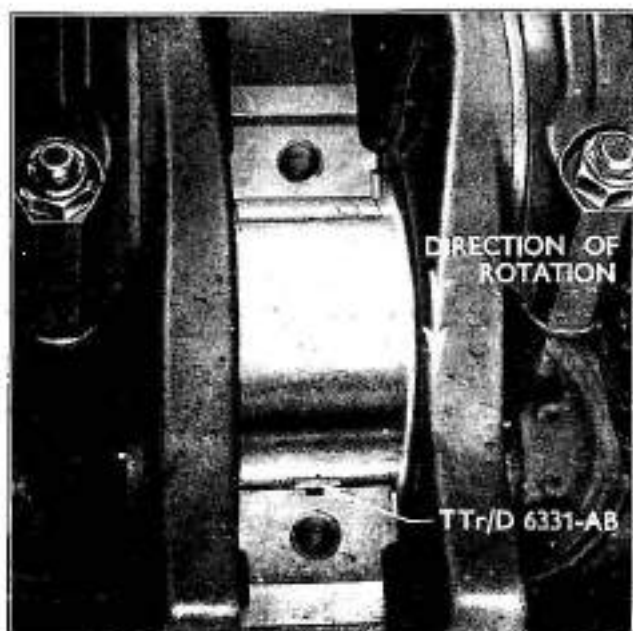

Fig. 42
Removing Main Bearing Liner

- 4 Carefully **turn** the crankshaft against the normal direction of rotation until the upper half of the liner is brought to such a position that it may be removed. (See Fig. 42.)
- 5 To instal the new upper half liner, lightly oil the crankshaft journal and position the liner on the journal so that its tongue is on the opposite side to the machined recess it is intended to fit in the block.
- 6 Hold the liner tightly against the journal and by turning the crankshaft in the normal direction of rotation, enter the liner into its location as far as it will go. If it is found that the liner is not fully home insert the special pin TTr/D 6331-AB in the oil hole in the crankshaft journal and continue to rotate the crankshaft until the liner is correctly positioned with both ends flush with the cylinder block. Remove the liner pin.
- 7 Clean both the cap and the new lower half liner, insert the liner in the cap so that the tongue enters the machined recess provided. Apply a film of oil to the liner bearing surface and replace the cap and the liner with the word "Rear" towards the rear of the engine. Always use new spring washers on the main bearing cap bolts. For complete details of the marking of main bearing caps refer to the following section.

MAIN BEARING CAPS

In manufacture, the main bearing liner bores in the cylinder block and caps are machined in-line, with the caps fitted in their correct locations. If the caps are interchanged or replaced incorrectly, they will not then match and possibly

lead to bearing failure with consequential damage to the engine.

It is for this reason that great care must be taken when the engine is dismantled to keep its own bearing caps separate from any others and refitted in exactly the same positions from which removed.

For identification purposes there is a single number or letter stamped on No. 2 cap and block location and a double letter or number on No. 4 cap and block location. These letters or numbers are on the opposite side to the engine camshaft.

No. 1 main bearing cap must be fitted with the machined face to the front, and before the bolts are tightened this face must be lined up with the aid of a straight edge with the front face of the block. Failure to do this may give rise to oil leakage across the front mounting plate gasket. Nos. 2, 3, 4 and 5 caps are marked with the word "Rear" on the casting and should be replaced with this word towards the rear of the engine.

MAIN BEARING BOLTS

The current type main bearing bolts used in production can be identified by the figures "100" marked on the head, and should be tightened to the torque shown in the specification.

Bolts marked "BEES," "NEWALL HIGH TENSILE" or "RIBE" should only be used as individual replacements to a complete set of similar bolts. The tightening torque figures for these are also shown in the specification.

Should it become necessary to use the current type bolts as individual replacements when stocks of the earlier bolts are exhausted, they should be tightened to the torque being used on the original bolts.



Fig. 43
Replacing Main Bearing Liner

THE FLYWHEEL AND RING GEAR

To remove the flywheel it will be necessary to separate the engine from the gearbox.

To Remove

- 1 Separate the engine from the gearbox as described in the section dealing with this subject on page 115.
- 2 Unscrew evenly the six bolts and spring washers securing the clutch pressure plate assembly to the flywheel and detach the clutch assembly and disc.
- 3 The flywheel is secured by six bolts with three locking plates. Bend back the locking tabs and unscrew the flywheel bolts.
- 4 Carefully ease the flywheel off the crankshaft spigot and the two locating dowels.

Note — For details of the clutch pilot bearing, refer to the clutch section.

To Renew the Flywheel Ring Gear

- 1 Unscrew the six countersunk headed screws retaining the ring gear to the flywheel and remove them and their lockwashers.
- 2 Tap off the ring gear. *There is no necessity to apply heat to remove or refit the gear.*
- 3 Fit a new ring gear with the countersunk holes to the front of the flywheel and retain in position by using six new screws and lockwashers.

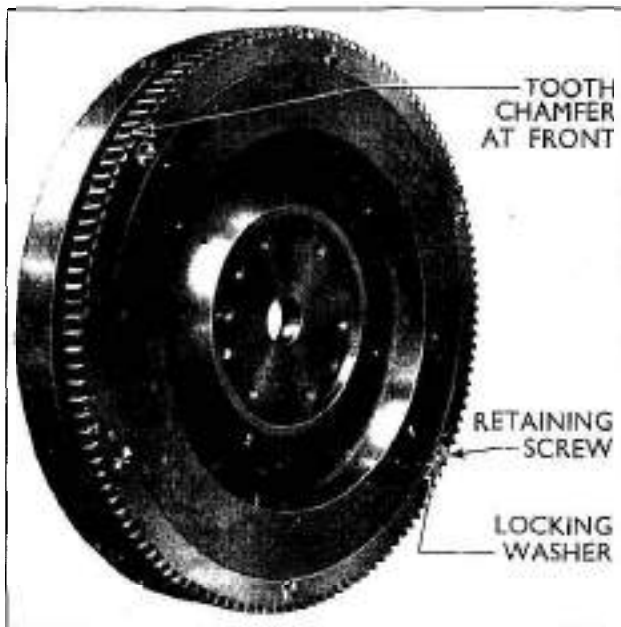

Fig. 44
Flywheel and Ring Gear



Fig. 45
Testing Flywheel Run-out

Note — The diesel flywheel ring gear is not interchangeable with that of either the vaporising oil or petrol engines. It is identified by the fact that the chamfer on the gear teeth is on the same end as the countersinking for the retaining screws. (See Fig. 44.)

To Replace the Flywheel

- 1 Carefully clean the crankshaft flange and the mating flange on the flywheel.
- 2 Ensure that the flywheel dowels are installed in the crankshaft rear flange.
- 3 Mount the flywheel on the flange ensuring that the dowel holes are lined up with the crankshaft dowels.

Fit the six bolts and the three locking plates and tighten up the bolts to the specified torque.

- 4 It is essential that the flywheel runs true, as dirt, etc., between the mating flange faces could cause it to run out of balance, with consequent difficulties. The clutch thrust face and flywheel rim should be tested with a dial indicator, when the "run-out" (total indicator reading) should not exceed 0.005 in. (see Fig. 45).

If the run-out exceeds this figure, remove the flywheel and check the mating flanges for burrs, etc.

Refit to the crankshaft and recheck the "run-out" as above.

Turn up the tabs of the locking plates against the flat on the bolts.

- 5 Replace the clutch assembly and engine as described in their appropriate sections.

MAJOR REPAIR OPERATIONS

Most operations of dismantling and repair can be carried out without removing the engine from the tractor, but should removal be necessary the following procedure should be adopted ;—

?

To Remove the Engine

- 1 Drain the cooling system through the taps on the radiator and the cylinder block.
- 2 Remove the sump drain plug and drain off the engine oil. Remove the engine oil indicator.
- 3 Turn the fuel tap to the "off" position and remove the fuel lift pump and pipes.
- 4 Remove the two screws on the rear clip of the engine hood and lift off the bonnet (if a vertical extension pipe and primary air cleaner are fitted, remove these first).
- 5 Disconnect the battery leads and remove the battery.
- 6 Disconnect the starter motor cables and generator leads. (Coil up the wiring so that it does not become damaged.) Remove the starter motor, generator assembly, fan belt and fan blades.
- 7 Disconnect the temperature gauge connection in the cylinder head and release the capillary tubing from its clips.
- 8 Disconnect the throttle control rod at each end, slide the rod clear of the engine and remove the vertical operating rod.
- 9 Unscrew the pinch screw on the stop lever and disconnect the stop control wire.
- 10 Remove the banjo bolt from the leak-off pipe union at the offside rear of the cylinder head.
- 11 Remove the injection pump and blank off all connections, taking necessary precautions to prevent ingress of dirt. (See Fuel System section.) Withdraw the throttle relay spindle running across the block.
- 12 Remove the fuel oil filter and pipes. Use plugs (tool No. Tr/DD 993122) to blank the filter connections.
- 13 On the horizontal exhaust remove the two bolts and one nut from the manifold adaptor and the two bolts, one securing the silencer bracket to the side channel and the other securing the outlet pipe bracket to the rear axle housing. With a vertical exhaust, remove the two bolts and nuts from the vertical exhaust flange.
- 14 Unscrew the clips at either end of the air intake pipe between the air cleaner and the inlet manifold and remove the pipe and the inlet and exhaust manifold.
- 15 Remove the rod operating the radiator shutter and detach the tool box (two bolts).
- 16 Pull out the snap connectors of the headlamp wiring on the right-hand side of the tractor, near the radiator, and release the wiring.
- 17 Disconnect the steering drag link by removing the split pin and unscrewing the drag link front ball plug.
- 18 Support the engine and transmission using the tractor dismantling stand (tool No. Tr/NMD 27). Place the two rail sections under the tractor and position the engine and gearbox trolleys.
- 19 Place the front axle wedge (tool No. Tr2/NMD 3004) in position to prevent movement between the engine and front axle assemblies.
- 20 Lock the track rod by means of the front axle clamp (tool No. Tr/ND 3000).
- 21 Remove the four bolts on each side retaining the side channels to the gearbox and the bolts retaining the engine to the gearbox. Do not forget the two bolts behind the side channels.
- 22 Withdraw the engine, radiator and front axle assembly. Move the assembly forward until the engine is clear of the gearbox.
- 23 Fit the two engine lifting plates (tool No. TTr/D 6004), one on the fuel filter boss at the offside rear of the cylinder head and the other under the two front near-side cylinder head bolts. Take the weight of the engine on a hoist or gantry.
- 24 Disconnect the radiator hoses and free the radiator tie bar from the engine.
- 25 Remove the front axle radius rod rear pin after removing the split pin.
- 26 Remove the four bolts from the front of the side channel on the left-hand side and the radiator shell bolt.
- 27 Remove the three bolts from the engine front mounting to each side channel, and remove the side channel from the left-hand side.
- 28 Remove the engine by lifting it slightly and pushing it carefully towards the left-hand side so that the radius rod slides sideways out of its sump location and the front mounting plate clears the right-hand side channel. Lift the engine a little higher, then wheel away the front axle and radiator assembly.

SEQUENCE FOR DISMANTLING THE ENGINE

Note — The following sequence is given as a guide and, where necessary, reference can be made to the appropriate sections for detailed instructions covering the dismantling and reassembling of any particular sub-assembly.

- 1 Mount the engine on the engine stand (tool No. 200) in the normal manner, using the special bracket TTr/D 6005, which is available for this purpose.
- 2 Remove the water pump and cylinder block drain tap.
- 3 Remove the generator mounting brackets
- 4 Unscrew the crankshaft ratchet using the tool TTr/D 6319 and withdraw the crankshaft pulley using the remover tool TTr/D 6312-A.
- 5 Remove the two bolts retaining the rocker cover and lift off the cover and gasket.
- 6 Remove the rocker shaft support bolts, disconnect the decompressor control, and detach the rocker shaft assembly. Lift out the push rods.
- 7 Disconnect the fuel leak-off pipe and remove the injectors, taking the recommended precautions regarding cleanliness.
- 8 Unscrew the cylinder head bolts and lift off the cylinder head and gasket. To dismantle the cylinder head assembly refer to page 7.
- 9 Remove the tappet chamber cover screws and detach the cover and gasket.
- 10 Invert the engine on the stand and remove the external oil filter, sump cover plate, gasket and oil screen. Unscrew the bolts retaining the sump to the cylinder block and lift off the sump and gaskets.
- 11 Remove the suction pipe and oil pump.
- 12 Remove the connecting rods and pistons as described in the appropriate section.
- 13 Remove the clutch assembly taking care to slacken the pressure plate to flywheel bolts evenly.
- 14 Unscrew the bolts securing the flywheel to the crankshaft flange and ease off the flywheel, after removing the clutch pilot bearing (if necessary) using the tool TTr/D 7600-A. Remove the six screws retaining the ring gear to the flywheel and tap off the ring gear. There is no necessity to apply heat.

Note — The flywheel locates on the crankshaft spigot and two dowels.

- 15 Remove the timing cover, gasket and gears.
- 16 Withdraw the crankshaft gear using the tool ATTr/NVMD 6036-A, and extract both Woodruff keys from the front of the crankshaft. On current engines a long single key is fitted.

- 17 Remove the front mounting plate and gasket, and detach the oil relief valve.
- 18 Remove the auxiliary drive shaft and oil seal.
- 19 Remove the main bearing bolts, caps, liners and crankshaft thrust washers. Carefully lift out the crankshaft and extract the upper halves of the thrust washers and main bearing liners. Remove the rear main bearing oil seal retainer and extract the seal.
- 20 Ease the camshaft out sufficiently to permit removal of the thrust washers and then carefully remove the camshaft, taking care not to damage the cams and bores. Lift out the tappets.
- 21 Using the tool TTr/D 6055-A withdraw the cylinder liners and remove the seals from their recesses in the block.
- 22 Remove the plug from each end of the main oil gallery, and unscrew the block connection for the oil gauge pressure pipe. Remove any loose scale or deposit from the water jacket and thoroughly clean the block oil passages and tapped holes for the main bearing cap bolts on the oil gallery side before carrying out any further work.

Note — It is most important that the cylinder block is carefully and thoroughly cleaned in all respects and this operation not neglected in any way.

SEQUENCE FOR REASSEMBLING THE ENGINE

Before reassembling the engine, all parts will require checking dimensionally against the general specification and new parts selected where necessary. Lubricate all bearing surfaces and moving parts before assembly and soak the new rear oil seal in oil for one hour before fitting.

- 1 Refit the blanking plugs at each end of the main oil gallery. Mount the rear oil seal retainer and seal and install the oil pressure gauge union in the block.

Note — Oversize oil gallery blanking plugs are available, and when fitting the plugs a sealing compound should be used sparingly and the front plug fitted just below flush.

- 2 Install the new water seals for the liners in the recesses in the cylinder block and fit the cylinder liners after checking for protrusion as described in the appropriate section.
- 3 Fit the tappets and camshaft after checking the end-float.
- 4 Fit the top halves of the main bearing liners and thrust washers, install the crankshaft and fit the main bearing caps, bottom half liners and thrust washers. Check the crankshaft end-float.

- 5 Install the auxiliary drive shaft and fit the oil seal, using the tool Tr2/DD 66610-B.
- 6 Refit the mounting plate and gasket. Install the oil relief valve. Fit the Woodruff keys in the crankshaft spigot and reassemble the timing gears. On current engines a long single key is fitted. Refit the timing cover and gasket, crankshaft pulley and ratchet and the generator mounting brackets.
- 7 Refit the ring gear to the flywheel, mount the flywheel on the crankshaft spigot and install the clutch pilot bearing using the tool Tr2/D 7600-E.
- 8 Locate the piston and connecting rod assemblies in the appropriate bores with the word "Front" stamped on each piston crown pointing to the front of the engine. Compress the piston rings, using the squeezer TTr/DDK 6153 and push the pistons down the cylinder bores and reassemble the big ends to the crankshaft. Always use new self-locking nuts. Check the end-float of each connecting rod.
- 9 Mount the oil pump in the base of the block and fit the suction pipe. Install the sump and gaskets, tightening the bolts evenly. Replace the oil pump screen, cover plate and gasket.
- 10 Turn the engine over on the mounting stand and fit the rocker feed oil seal. Replace the cylinder head and gasket, using the locating studs TTr/MD 6050 and tighten the cylinder head bolts in correct sequence. Do not forget to refit the lifting plates TTr/D 6004.
- 11 Install the push rods and rocker shaft assembly and reconnect the decompressor control. Reset the valve clearances.
- 12 Refit the injectors and leak-off pipe.
- 13 Refit the tappet chamber cover and gasket.
- 14 Install the rocker cover and gasket.
- 15 Mount the water pump and gasket in position. Refit the drain tap.
- 16 Refit the external oil filter.
- 17 Mount the clutch and pressure plate assembly into position, using the clutch plate locator Tr/D 7563.
- 18 Remove the engine from the mounting stand.
- 6 Fit the left-hand side channel, bolting it to the front mounting foot using three bolts and replace the radiator shell bolt. Install the engine trolley part of the dismantling stand and remove the sling.
- 7 Wheel the front axle and engine assembly towards the transmission and engage the drive shaft in the clutch disc splines and pilot bearing.
- 8 Replace the bolts retaining the engine to the gearbox and the four bolts holding each side channel to the gearbox.
- 9 Refit the generator, fan belt and blades.
- 10 Refit the two radiator hoses and the radiator tie-bar to the engine.
- 11 Remove the engine lifting plates and tighten the cylinder head bolts to the specified torque.
- 12 Reconnect the steering drag link.
- 13 Fit the inlet and exhaust manifold and replace the air intake pipe between the air cleaner and the inlet manifold.
- 14 Fit the starter motor and reconnect the cables and generator leads.
- 15 Reconnect the headlamp wiring by joining the snap connectors and refit the three wiring clips.
- 16 Replace the rod operating the radiator shutter and install the tool box.
- 17 Replace the fuel filter and its pipes.
- 18 Secure the leak-off pipe to the offside rear of the cylinder head by means of the banjo bolt.
- 19 Refit the throttle relay spindle running across the block.
Install the injection pump and all connections. (See Fuel System section.)
- 20 Reconnect the stop control wire and tighten up the pinch screw.
- 21 Refit the throttle control rod and connect the vertical operating rod.
- 22 Replace the temperature gauge and refit the clips holding the capillary tubing.
- 23 Install the fuel lift pump and reconnect the pipes.
- 24 Replace the battery and refit the battery leads.
- 25 Replace the engine bonnet and secure by screwing in the two screws on the rear clip. (If a vertical primary air cleaner is fitted, replace this at this stage.)
- 26 Refit the exhaust pipe adaptor. If a horizontal exhaust system is fitted, replace the two bolts securing the silencer bracket to the side channel and the outlet clamp to the axle housing.
- 27 Turn the fuel tap to the "ON" position and "bleed" all the air from the fuel system. (See Fuel System section.)
- 28 Refill the engine with clean oil of an approved grade and replace the oil indicator.

To Replace the Engine

- 1 Support the radiator and front axle assembly by using a suitable block or jack under the right-hand side channel and place blocks at either side of the wheels.
- 2 Lift the engine, using an overhead sling, and position it so that the radius rod location is to the left hand and just above the level of the radius rod eye.
- 3 Push the engine sideways towards the right-hand side and at the same time gently lower it, guiding the right-hand side of the front mounting plate into its side channel and the radius rod eye in its correct location.
- 4 Fit the radius rod pin and split pin.
- 5 Secure the front mounting foot to the right-hand side channel using the three bolts.

THE CRANKSHAFT

The cast-steel crankshaft is **statically** and dynamically balanced. It should be ring tested for cracks before replacing by suspending the crankshaft suitably by one end and lightly tapping with a hand hammer.

The **crankshaft** should always be thoroughly checked before replacement to ensure that all oil passages are clear and perfectly dean in all respects.

Reference to the specification will indicate the dimensions of parts available for service.

To Remove

- 1 Remove the engine from the tractor as described on page 31.
- 2 Remove the clutch assembly.
- 3 Remove the crankshaft pulley.
- 4 Remove the timing cover and gasket.
- 5 Remove the timing gears as described on page 24.
- 6 Remove the front mounting plate and gasket.
- 7 Remove the sump and gaskets.
- 8 Remove the oil pump.
- 9 Unscrew the **connecting** rod big end cap nuts, detach the caps and push the pistons up the cylinder bores. Take care not to dislodge the big end bearing liners in the rods and caps.
- 10 Remove the **flywheel** (see page 30).
- 11 Unscrew the main bearing cap bolts and detach the caps. When removing the centre **main** bearing cap take care not to lose the crankshaft thrust washers from either side of the cap.
- 12 Lift the crankshaft carefully out of the cylinder block.
- 13 Extract the upper halves of the main bearing liners and thrust washers from the cylinder block, and the halves of the **crankshaft** rear oil seals from the sump and the oil seal retainer.
- 14 Thoroughly clean all the oil passages in the block after removing the plugs at each end of the main oil gallery and the oil gauge adaptor in the block. The crankshaft **must** also be **cleaned**. This operation is most important and must be carried out in detail.

To Replace

- 1 Locate the upper halves of the main hearing liners in their block locations. Ensure that all **oilways** and passages are clear, and lightly lubricate the liners.

- 2 Fit the new crankshaft rear oil seal, upper half, in the oil seal retainer and the lower **half** in the rear of the sump. This oil seal should be previously soaked in engine oil for at least one hour.
- 3 Locate the upper halves of the crankshaft end-float **thrust** washers on either side of the centre main bearing with the oil grooves outwards. The upper halves of these washers do not have locating tabs.
- 4 Check that the ends of the thrust washers are level with the cylinder block face, otherwise they may be distorted when fitting the bearing cap. A light coating of oil will assist in holding the washers in place until the crankshaft is fitted.

Insert new keys at the front end of the crankshaft, lubricate the bearing liners and lay the crankshaft in the bearings.

- 5 Check that the **liners** are seating correctly in the caps **with** the tongues engaging in the machined recesses and that the end-float thrust washers are located on either side of the centre main bearing.

The washers must be fitted with the oil grooves outwards and the locating tabs in the recesses of the **cap**.

- 6 Refit the main bearing caps with the cast word "Rear" to the rear of the engine.
- 7 **Push** the crankshaft fully **endwise** and check the end-float as shown in Fig. 41, which should be within the **limits specified**. If this limit is exceeded, fit thicker thrust washers.
- 8 Refit the connecting rods to the crankpins, ensuring that the liners are correctly positioned with the tongues engaging in the machined recesses. Connecting rod caps must be fined with the stamped numbers together and on the same side as the camshaft.
- 9 Use new **self-locking** nuts on the big end bearing bolts and tighten to the specified torque. Ensure that the heads of the bolts are **correctly** located.
- 10 Replace the oil pump and suction pipe.
- 11 Refit front mounting plate and gasket.
- 12 Replace the timing gears as **described** on page 24.
- 13 Replace the timing cover, gasket, and crankshaft pulley.
- 14 Refit the sump and gaskets, see page 16.
- 15 Replace the flywheel and clutch assembly, checking the "run-out" as described on page 30.
- 16 Refit the engine to the tractor as described on page 33.