

Operation & Maintenance Manual

SEAM010700

WA20-2, WA30-5

WA40-3, WA50-3

WHEEL LOADER

SERIAL NUMBERS

WA20 - 11270	
WA30 - 18970	and up
WA40 - 13530	
WA50 - 20642	

⚠ WARNING

Unsafe use of this machine may cause serious injury or death. Operators and maintenance personnel must read this manual before operating or maintaining this machine. This manual should be kept near the machine for reference and periodically reviewed by all personnel who will come into contact with it.

NOTICE

Komatsu has Operation & Maintenance Manuals written in some other languages. If a foreign language manual is necessary, contact your local distributor for availability.

KOMATSU

1. FOREWORD

This manual provides rules and guidelines which will help you use this machine safely and effectively. Keep this manual handy and have all personnel read it periodically. If this manual has been lost or has become dirty and can not be read, request a replacement manual from Komatsu or your Komatsu distributor.

If you sell the machine, be sure to give this manual to the new owners.

Continuing improvements in the design of this machine can lead to changes in detail which may not be reflected in this manual. Consult Komatsu or your Komatsu distributor for the latest available information of your machine or for questions regarding information in this manual.

This manual may contain attachments and optional equipment that are not available in your area. Consult Komatsu or your Komatsu distributor for those items you may require.

WARNING

- **Improper operation and maintenance of this machine can be hazardous and could result in serious injury or death.**
- **Operators and maintenance personnel should read this manual thoroughly before beginning operation or maintenance.**
- **Some actions involved in operation and maintenance of the machine can cause a serious accident, if they are not done in a manner described in this manual.**
- **The procedures and precautions given in this manual apply only to intended uses of the machine. If you use your machine for any unintended uses that are not specifically prohibited, you must be sure that it is safe for you and others. In no event should you or others engage in prohibited uses or actions as described in this manual.**
- **Komatsu delivers machines that comply with all applicable regulations and standards of the country to which it has been shipped. If this machine has been purchased in another country or purchased from someone in another country, it may lack certain safety devices and specifications that are necessary for use in your country. If there is any question about whether your product complies with the applicable standards and regulations of your country, consult Komatsu or your Komatsu distributor before operating the machine.**
- **The description of safety is given in SAFETY INFORMATION on page 0-2 and in SAFETY from page 1-1.**

CALIFORNIA

Proposition 65 Warning

Diesel engine exhaust and some of its constituents are known to the State of California to cause cancer, birth defects, and other reproductive harm.

2. SAFETY INFORMATION

Most accidents are caused by the failure to follow fundamental safety rules for the operation and maintenance of machines. To avoid accidents, read, understand and follow all precautions and warnings in this manual and on the machine before performing operation and maintenance.

To identify safety messages in this manual and on machine labels, the following signal words are used.

-  **DANGER** – This word is used on safety messages and safety labels where there is a high probability of serious injury or death if the hazard is not avoided. These safety messages or labels usually describe precautions that must be taken to avoid the hazard. Failure to avoid this hazard may also result in serious damage to the machine.

-  **WARNING** – This word is used on safety messages and safety labels where there is a potentially dangerous situation which could result in serious injury or death if the hazard is not avoided. These safety messages or labels usually describe precautions that must be taken to avoid the hazard. Failure to avoid this hazard may also result in serious damage to the machine.

-  **CAUTION** – This word is used on safety messages and safety labels for hazards which could result in minor or moderate injury if the hazard is not avoided. This word might also be word for hazards where the only result could be damage to the machine.

- NOTICE** – This word is used for precautions that must be taken to avoid actions which could shorten the life of the machine.

Safety precautions are described in SAFETY from page 1-1.

Komatsu cannot predict every circumstance that might involve a potential hazard in operation and maintenance. Therefore the safety messages in this manual and on the machine may not include all possible safety precautions. If any procedures or actions not specifically recommended or allowed in this manual are used, you must be sure that you and others can do such procedures and actions safely and without damaging the machine. If you are unsure about the safety of some procedures, contact your Komatsu distributor.

3. INTRODUCTION

3.1 INTENDED USE

This machine is intended mainly for the following operations.

- Digging operations
- Leveling operations
- Pushing operations
- Loading operations

For details of the operating procedure, see "12.9 WORK POSSIBLE USING WHEEL LOADER".

3.2 FEATURES

- Easy operation by HST mechanism
- High performance
- Each kind of safety devices is installed.

3.3 BREAKING IN THE MACHINE

Your Komatsu machine has been thoroughly adjusted and tested before shipment.

However, operating the machine under severe conditions at the beginning can adversely affect the performance and shorten the machine life.

Be sure to break in the machine for the initial 100 hours (as indicated by the service meter.)

During breaking in:

- Idle the engine for 5 minutes after starting it up.
- Avoid operation with heavy loads or at high speeds.
- Avoid sudden starts, sudden acceleration, sudden steering and sudden stops except in cases of emergency.

The precautions given in this manual for operating, maintenance, and safety procedures are only those that apply when this product is used for the specified purpose. If the machine is used for a purpose that is not listed in this manual, Komatsu cannot bear any responsibility for safety. All consideration of safety in such operations is the responsibility of the user.

Operations that are prohibited in this manual must never be carried out under any circumstances.

4. LOCATION OF PLATES, TABLE TO ENTER SERIAL NO. AND DISTRIBUTOR

4.1 MACHINE SERIAL NO. PLATE POSITION

4.1.1 WA20

Position of plate

This plate is on the center of the front frame on the right side of the machine.

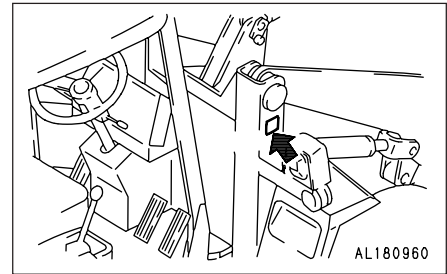

Position of stamp

This is stamped on the center of the front frame on the right side of the machine.

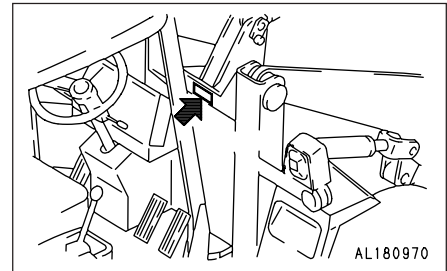

4.1.2 WA30, 40, 50

Position of plate

This plate is on the center of the front frame on the right side of the machine.

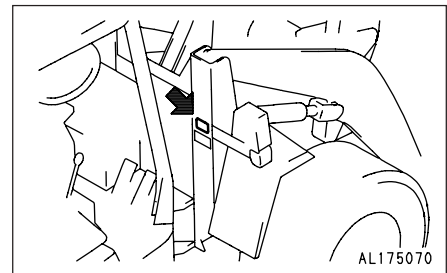

Position of stamp

This is stamped on the center of the front frame on the right side of the machine.

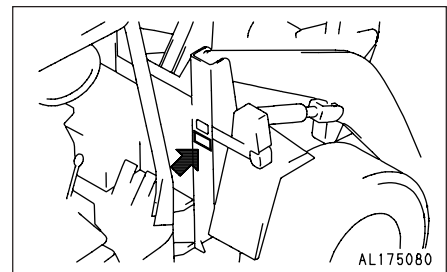

4.2 ENGINE SERIAL NO. PLATE POSITION

Position of plate

This plate is on top of the engine cylinder head cover.

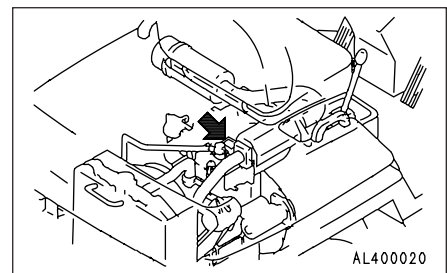

Position of stamp

This is stamped on the right side of the engine cylinder block as seen from the fan.

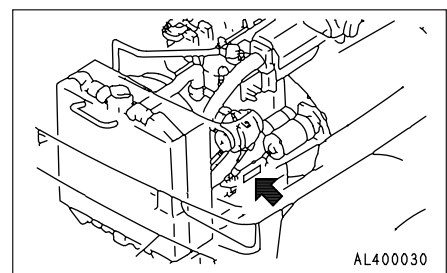

4.3 TABLE TO ENTER SERIAL NO. AND DISTRIBUTOR

Machine serial No.:	
Engine serial No.:	
Distributor name:	
Address:	Phone:
Service personnel for your machine:	

REMARKS

5. CONTENTS

1. Foreword	0- 1
2. Safety information	0- 2
3. Introduction	0- 3
4. Location of plates, table to enter serial No. and distributor	0- 4

SAFETY

6. General precautions	1- 2
7. Precautions during operation	1- 7
7.1 Before starting engine	1- 7
7.2 Operating machine	1- 9
7.3 Transportation	1-14
7.4 Battery	1-15
7.5 Towing	1-16
8. Precautions for maintenance	1-17
8.1 Before carrying out maintenance	1-17
8.2 During maintenance	1-21
8.3 Tires	1-25
9. Position for attaching safety labels	1-27

OPERATION

10. General view	2- 2
10.1 General view of machine	2- 2
10.2 General view of controls and gauges	2- 3
11. Explanation of components	2- 4
11.1 Meter, lamps	2- 4
11.2 Switches	2- 8
11.3 Control levers, pedals	2-10
11.4 Cap with lock	2-14
11.5 Safety bar	2-14
11.6 Tilt hood	2-15
11.7 Towing pin	2-15
11.8 Fuse	2-15
11.9 Fusible link	2-16
11.10 Manual pocket	2-17
11.11 Connectors	2-17

12. Operation	2-18
12.1 Check before starting engine	2-18
12.2 Starting engine	2-29
12.3 Operations and checks after starting engine	2-32
12.4 Moving machine off	2-34
12.5 Changing direction	2-36
12.6 Turning	2-36
12.7 Stopping machine	2-37
12.8 Operation of work equipment	2-38
12.9 Work possible using wheel loader	2-39
12.10 Precautions for operation	2-43
12.11 Adjusting work equipment posture	2-45
12.12 Parking machine	2-46
12.13 Checks after completion of operation	2-47
12.14 Stopping engine	2-48
12.15 Check after stopping engine	2-48
12.16 Locking	2-48
12.17 Handling the tires	2-49
13. Transportation	2-52
13.1 Loading, unloading work	2-52
13.2 Precautions for loading	2-53
13.3 Lifting machine	2-53
13.4 Precautions for transportation	2-56
13.5 Removing and installation of canopy	2-56
14. Cold weather operation	2-58
14.1 Precautions for low temperature	2-58
14.2 Precautions after completion of work	2-60
14.3 After cold weather	2-60
15. Long-term storage	2-61
15.1 Before storage	2-61
15.2 During storage	2-61
15.3 After storage	2-61
16. Troubleshooting	2-62
16.1 When machine runs out of fuel	2-62
16.2 Towing the machine	2-63
16.3 If battery is discharged	2-66
16.4 Other trouble	2-70

MAINTENANCE

17. Guides to maintenance	3- 2
18. Outlines of service	3- 5
18.1 Outline of oil, fuel, coolant	3- 5
18.2 Outline of electric system	3- 8
19. Wear parts list	3- 9
20. Use of fuel, coolant and lubricants according to ambient temperature	3-10
21. Standard tightening torques for bolts and nuts	3-14
21.1 Introduction of necessary tools	3-14
21.2 Torque list	3-16
22. Periodic replacement of safety critical parts	3-17
23. Maintenance schedule chart	3-24
23.1 Maintenance schedule chart	3-24
24. Service Procedure	3-27
24.1 Initial 250 hours service	3-27
24.2 When required	3-28
24.3 Check before starting	3-42
24.4 Every 50 hours service	3-48
24.5 Every 250 hours service	3-49
24.6 Every 500 hours service	3-54
24.7 Every 1000 hours service	3-57
24.8 Every 2000 hours service	3-60

SPECIFICATIONS

25. Specifications	4- 2
---------------------------------	------

OPTIONS, ATTACHMENTS

26. Optional parts and attachments	5- 2
27. Seat belt	5- 3
27.1 Fastening and removing belt	5- 3
27.2 Adjust belt length	5- 4
27.3 Check seat belt and mounts	5- 4
28. Equipment with cab	5- 5
28.1 Switches	5- 5
28.2 Rear window	5- 9
28.3 Check and maintenance	5-10

SAFETY



WARNING

Read and follow all safety precautions. Failure to do so may result in serious injury or death.

This safety section also contains precautions for optional equipment and attachments.

6. GENERAL PRECAUTIONS

⚠ WARNING: For reasons of safety, always follow these safety precautions.

SAFETY RULES

- ONLY trained and authorized personnel can operate and maintain the machine.
- Follow all safety rules, precautions and instructions when operating or performing maintenance on the machine.
- Do not operate the machine if you are not feeling well, or if you are taking medicine which will make you sleepy, or if you have been drinking. Operating in such a condition will adversely affect your judgement and may lead to an accident.
- When working with another operator or a person on worksite traffic duty, be sure all personnel understand all hand signals that are to be used.

SAFETY FEATURES

- Be sure all guards and covers are in their proper position. Have guards and covers repaired if damaged.
Proper position → See "12.1.1 WALK-AROUND CHECK".
- Use safety features such as the safety lock lever and seat belts properly.
- NEVER remove any safety features. ALWAYS keep them in good operating condition.
Safety lock lever → See "12.12 PARKING MACHINE".
- Improper use of safety features could result in serious bodily injury or death.

CLOTHING AND PERSONAL PROTECTIVE ITEMS

- Avoid loose clothing, jewelry, and loose long hair. They can catch on controls or in moving parts and cause serious injury or death. Also, do not wear oily clothes because they are flammable.
- Wear a hard hat, safety glasses, safety shoes, mask or gloves when operating or maintaining the machine. Always wear safety goggles, hard hat and heavy gloves if your job involves scattering metal chips or minute materials - this is so particularly when driving pins with a hammer and when cleaning the air cleaner element with compressed air. Check also that there is no one near the machine.
- Check the function of all protective equipment before use.
Cleaning of air cleaner element → See "24.2 WHEN REQUIRED" in service procedure.

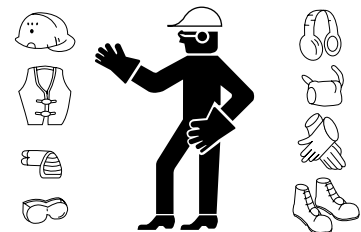

A0055010

⚠ WARNING: Failure to follow these safety precautions may lead to a serious accident.

UNAUTHORIZED MODIFICATION

- Any modification made without authorization from Komatsu can create hazards.
- Before making a modification, consult your Komatsu distributor. Komatsu will not be responsible for any injury or damage caused by any unauthorized modification.

ALWAYS APPLY LOCK WHEN LEAVING OPERATOR'S SEAT

- When standing up from the operator's seat, always place the safety lock lever securely in the LOCK position. If you accidentally touch the travel or swing lever when they are not locked, the work equipment may suddenly move and cause serious injury or damage.
- When leaving the machine, lower the work equipment completely to the ground, set the safety lock lever to the LOCK position, then stop the engine and use the key to lock all the equipment. Always take the key with you.

Work equipment posture → See "12.12 PARKING MACHINE".

Locks → See "12.16 LOCKING".

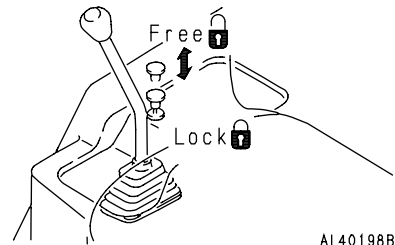

AL40198B

MOUNTING AND DISMOUNTING

- NEVER jump on or off the machine. NEVER get on or off a moving machine.
- When getting on or off the machine, face the machine and use the handhold and steps.
- Never hold any control levers when getting on or off the machine.
- Maintain three-point contact (both feet and one hand or one foot and both hands), and be sure that you are supported securely by the handrail and steps.
- If there is any oil, grease, or mud on the handholds or steps, wipe it off immediately. Always keep these parts clean. Repair any damage and tighten any loose bolts.



AL187320

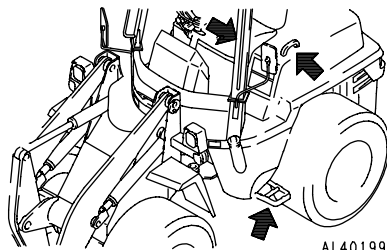

AL401990

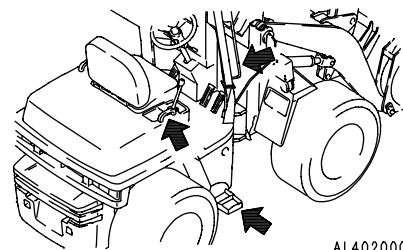

AL402000

FIRE PREVENTION FOR FUEL AND OIL

Fuel, oil, and antifreeze can be ignited by a flame. Fuel is particularly **FLAMMABLE** and can be **HAZARDOUS**.

- Keep flame away from flammable fluids.
- Stop the engine and do not smoke when refueling.
- Tighten all fuel and oil tank caps securely.
- Refueling and oiling should be made in well ventilated areas.
- Keep oil and fuel in the determined place and do not allow unauthorized persons to enter.



A0055020



A0055030



A0055040

PRECAUTIONS WHEN HANDLING AT HIGH TEMPERATURES

- Immediately after operations are stopped, the engine coolant, engine oil, and hydraulic oil are at high temperatures, and are still under pressure. Attempting to remove the cap, drain the oil or water, or replace the filters may lead to serious burns. Always wait for the temperature to go down, and follow the specified procedures when carrying out these operations.
- Before removing the radiator cap, stop the engine and let the radiator cool. Turn the cap slowly to release the internal pressure before removing the cap.
- As a result, oil may spurt out when the hydraulic tank cap is removed. Always turn the cap slowly to release the internal pressure before removing the cap.

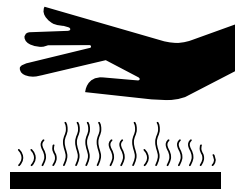

A0055050

ASBESTOS DUST HAZARD PREVENTION

Asbestos dust can be HAZARDOUS to your health if it is inhaled.

If you handle materials containing asbestos fibers, follow these guidelines as given below:

- NEVER use compressed air for cleaning.
- Use water for cleaning to keep down the dust.
- Operate the machine with the wind to your back, whenever possible.
- Use an approved respirator if necessary.



A0055060

CRUSHING OR CUTTING PREVENTION

- Do not enter, or put your hand or arm or any other part of your body between movable parts such as between the work equipment and cylinders, or between the machine and work equipment. If the work equipment is operated, the clearance will change and this may lead to serious damage or personal injury.

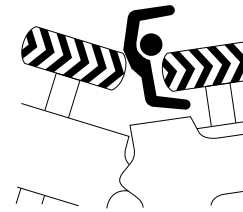

A0060760

FIRE EXTINGUISHER AND FIRST AID KIT

- Be sure fire extinguishers have been provided and know how to use them.
- Provide a first aid kit at the storage point.
- Know what to do in the event of a fire.
- Be sure you know the phone numbers of persons you should contact in case of an emergency.

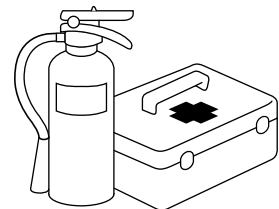

A0055070

PRECAUTIONS WHEN USING ROPS

If ROPS is installed, the ROPS must never be removed when operating the machine.

The ROPS is installed to protect the operator if the machine should roll over. It is designed not only to support the load if the machine should roll over, but also to absorb the impact energy.

The Komatsu ROPS fulfills all of the regulations and standards for all countries, but if it is rebuilt without authorization or is damaged when the machine rolls over, the strength will drop and it will not be able to fulfill its function properly. It can only display its performance if it is repaired or modified in the specified way.

When modifying or repairing the ROPS, always contact your Komatsu distributor.

Even if the ROPS is installed, it cannot show its full effect if the operator does not fasten the seat belt properly. Always fasten the seat belt when operating.

PRECAUTIONS FOR ATTACHMENTS

- When installing and using an optional attachment, read the instruction manual for the attachment and the information related to attachments in this manual.
- Do not use attachments that are not authorized by Komatsu or your Komatsu distributor. Use of unauthorized attachments could create a safety problem and adversely affect the proper operation and useful life of the machine.
- Any injuries, accidents, product failures resulting from the use of unauthorized attachments will not be the responsibility of Komatsu.

7. PRECAUTIONS DURING OPERATION

⚠ WARNING: Failure to follow these safety precautions may lead to a serious accident.

7.1 BEFORE STARTING ENGINE

SAFETY AT WORKSITE

- Before starting operations, thoroughly check the area for any unusual conditions that could be dangerous.
- Examine the shape of the ground and the quality of the soil at the jobsite, and determine the optimum method of operation.
- When working on public roads, position flagmen and erect barriers to ensure the safety of passing traffic and pedestrians.
- In places where there are buried objects, such as water pipes, gas pipes, or pipes for high voltage cables, contact the company in charge to confirm the position of the buried object, and be careful not to damage the object during operations.
- When working in water or when crossing sand banks, first check the condition of the ground and the depth and speed of flow of the water. Be sure not to exceed the permitted water depth.

Permissible water depth → See "12.10 PRECAUTIONS FOR OPERATION".

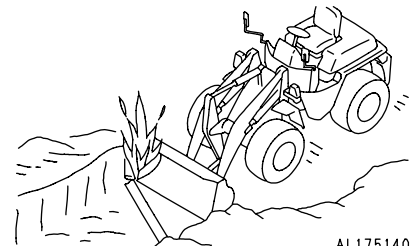

AL175140

FIRE PREVENTION

- Thoroughly remove wood chips, leaves, paper and other flammable things accumulated in the engine compartment. They could cause a fire.
- Check fuel, lubrication, and hydraulic systems for leaks. Have any leaks repaired. Wipe up any excess oil, fuel or other flammable fluids.

Check point → See "12.1.1 WALK-AROUND CHECK".

- Be sure a fire extinguisher is present and working.
- Do not operate the machine near any flame.



A0055020

IN OPERATOR'S CAB

- Do not leave tools or spare parts lying around in the operator's compartment. They may damage or break the control levers or switches. Always put them in the tool box on the right side of the machine.
- Keep the cab floor, controls, steps and handrails free of oil, grease, snow, and excess dirt.
- Check the seat belt, buckle and hardware for damage or wear. Replace any worn or damaged parts. Always use seat belts when operating your machine.

Seat belts → See "27. SEAT BELT".

VENTILATION FOR ENCLOSED AREAS

- If it is necessary to start the engine within an enclosed area, provide adequate ventilation. Exhaust fumes from the engine can KILL.



A0055060

PRECAUTIONS FOR MIRRORS, WINDOWS AND LIGHTS

- Remove all dirt from the surface of the windows and lights to ensure that you can see well.
- Adjust the side mirror so that you can see clearly from the operator's seat, and always keep the surface of the mirror clean. If any glass is broken, replace it with a new part.
- Check that the head lamps and working lamps light up properly.

CHECK MACHINE

- Before starting the engine, adjust the operator's seat so that you can carry work easily and in comfort.
If the operator's seat is not properly adjusted, it will cause mistaken operation and fatigue, with the danger that this will cause an accident.
- Adjust the seat so that you can operate the control levers and pedals properly with your back against the seat back.
Adjustment of operator's seat → See "12.1.3 ADJUSTMENT BEFORE OPERATION".
- Before starting the engine, check that the safety lock levers are at the LOCK position.
- Before starting the engine, always carry out the walk-around check, checks before starting, and operations and checks before starting the engine.
Walk-around check → See "12.1.1 WALK-AROUND CHECK".
Checks before starting → See "12.1.2 CHECK BEFORE STARTING".
Operations and checks before starting engine → See "12.1.4 OPERATIONS AND CHECKS BEFORE STARTING ENGINE".

Carry out the above checks and check that there is no abnormality. If there is damage which can not be repaired, attach the warning tag to the work equipment control lever.

7.2 OPERATING MACHINE

WHEN STARTING ENGINE

- Walk around your machine again just before mounting it, checking for people and objects that might be in the way.
- NEVER start the engine if a warning tag has been attached to the control.
- When starting the engine, sound the horn as an alert.
- Start and operate the machine only while seated.
- Do not allow any person other than the operator in the operator's compartment or any other place on the machine.
- For machines equipped with a back-up alarm buzzer, check that the alarm buzzer works properly.

CHECK WHEN TRAVELING IN REVERSE

Before operating the machine or work equipment, do as follows.

- Sound the horn to warn people in the area.
- Check that there is no one near the machine. Be particularly careful to check behind the machine.
- If necessary, designate a person to check the safety. This is particularly necessary when traveling in reverse.
- When operating in areas that may be hazardous or have poor visibility, designate a person to direct worksite traffic.
- Do not allow any one to enter the line of travel of the machine. This rule must be strictly observed even on machines equipped with a back-up alarm or rear view mirror.

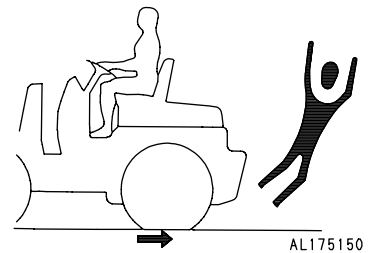

CHECK SAFETY

Before traveling or operating, check that the safety bar is securely fixed in the free condition.

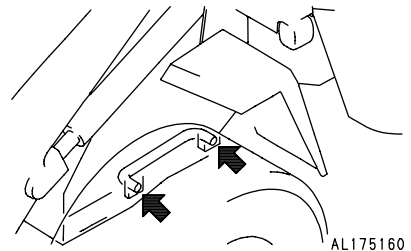

PRECAUTIONS WHEN TRAVELING

- It is dangerous to look around you when carrying out operations. Always concentrate on your work.
- Excessive speed, sudden starting, sudden stopping, sudden turns, and coasting when traveling are dangerous. Always drive carefully.
- If you find any abnormality in the machine during operations (noise, vibration, smell, abnormalities in gauges), move the machine immediately to a safe place, then park the machine and investigate the cause.
- Travel on level roads with the bucket 25 – 45 cm (10 – 18 in) above the ground surface.
- When traveling on rough ground surfaces, travel at low speed, and avoid sudden turning when changing direction.
- If the engine stops when the machine is traveling, the steering will not work. This is dangerous, so apply the brakes immediately and stop the machine.
- To avoid hitting other machines, always keep a safe distance from other machines during operations and when traveling.

TRAVELING ON SLOPES

- Traveling on hills, banks or slopes that are steep could result in the machine tipping over or slipping.
- On hills, banks or slopes, carry the bucket closer to the ground, approximately 20 to 30 cm (8 to 12 in) above the ground. In case of emergency, quickly lower the bucket to the ground to help the machine stop and prevent it from tipping over.
- Do not turn on slopes or travel across slopes. Always go down to a flat place to perform these operations.
- Do not travel up and down on grass, fallen leaves, and wet steel plates. These materials may allow the machine to slip, if it is traveling sideways. Keep travel speed very low.
- When traveling down a slope, use the braking force of the engine and travel slowly.
- If the engine stops on a slope, depress the brake immediately, lower the bucket, and apply the parking brake to stop the machine.
- When carrying a load, travel forward when going uphill and in reverse when going downhill.

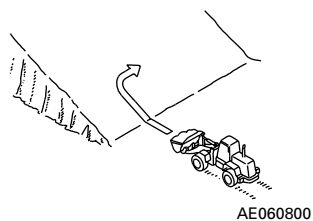
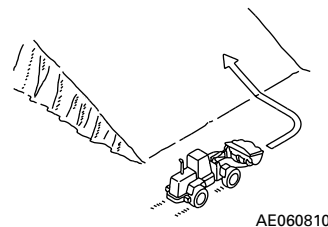
INCORRECT**CORRECT**

DO NOT GO CLOSE TO HIGH-VOLTAGE CABLES

- Going close to high-voltage cables can cause electric shock. Always maintain the safe distance given below between the machine and the electric cable.
- The following actions are effective in preventing accidents.
 - 1) Wear shoes with rubber or leather soles.
 - 2) Use a signalman to give warning if the machine approaches too close to the electric cable.
- If the work equipment should touch the electric cable, the operator should not leave the operator's compartment.
- When carrying out operations near high voltage cables, do not let anyone come close to the machine.
- Check with the electricity company about the voltage of the cables before starting operations.

Voltage	Min. safety distance	
	m	ft
6.6 kV	3 m	10ft
33.0 kV	4 m	14ft
66.0 kV	5 m	17ft
154.0 kV	8 m	27ft
275.0 kV	10 m	33ft

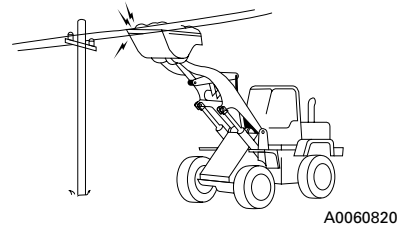

PRECAUTIONS WHEN OPERATING

- Be careful not to approach too close to the edge of cliffs. When making embankments or landfills, or when dropping soil over a cliff, dump one pile, then use the next pile of soil to push the first pile.
- Be careful not to let the bucket hit the dump truck or the side of the excavated ditch.
- The load suddenly becomes lighter when the soil is pushed over a cliff or when the machine reaches the top of a slope. When this happens, there is danger that the travel speed will suddenly increase, so be sure to reduce the speed.
- Always carry out loading operations up-wind to protect yourself from dust.
- When the bucket is fully loaded, be particularly sure to avoid sudden starting, turning, or stopping.
- When loading a dump truck, check that there is no one in the area. Be careful also that the load does not drop when it is being loaded.

ENSURE GOOD VISIBILITY

- When working in dark places, install working lamps and head lamps, and set up lighting in the work area if necessary.
- Stop operations if the visibility is poor, such as in mist, snow, or rain, and wait for the weather to improve to a condition that allows the operation to be carried out safely.

OPERATE CAREFULLY ON SNOW

- When working on snow or icy roads, there is danger that the machine may slip to the side on even the slightest slope, so always travel slowly and avoid sudden starting, turning, or stopping.
- Be extremely careful when carrying out snow-clearing operations. The road shoulder and other objects are buried in the snow and cannot be seen.
- When traveling on snow-covered roads, always install tire chains.
- When traveling on snow-covered slopes, never use the brakes to stop the machine suddenly. Lower the bucket to the ground to stop the machine.
- The load will change greatly according to the type of snow, so reduce the load and be careful not to let the machine slip.

DO NOT HIT WORK EQUIPMENT

- When working in places where there are height limits, such as in tunnels, under bridges, under electric cables, or in garages, be extremely careful not to hit the work equipment.

METHOD OF USING BRAKES

- Do not put your foot on the brake pedal unless necessary.
- Do not depress the brake pedal repeatedly unless necessary.
- When traveling downhill, use the engine as a brake, and always use the right brake pedal.

WORKING ON LOOSE GROUND

- Avoid operating your machine too close to the edge of cliffs, overhangs, and deep ditches. If these areas collapse, your machine could fall or tip over and result in serious injury or death. Remember that the soil after heavy rain or blasting is weakened in these areas.
- Earth laid on the ground and the soil near ditches are loose. They can collapse under the weight or vibration of your machine.
- When operating in places where there is danger of falling rocks or danger of the machine turning over, always install ROPS and a seat belt.

PARKING THE MACHINE

- When parking the machine, stop on a flat firm road surface where there is no danger of falling rocks, landslides, or floods, and lower the work equipment to the ground. If the machine must be stopped on a slope, block the wheels to prevent the machine from moving.

CORRECT

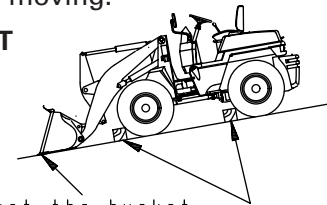

Thrust the bucket Blocks
AL41150B

- When parking on public roads, park the machine so that the machine, flags, and fences do not obstruct traffic, and provide fences, signs, flags, or lights, and put up any other necessary signs to ensure that passing traffic can see the machine clearly.
Parking procedure → See "12.12 PARKING MACHINE".
- When leaving the machine, lower the work equipment completely to the ground, set the safety lock lever to the LOCK position, then stop the engine and use the key to lock all the equipment. Always take the key with you.
Work equipment posture → See "12.12 PARKING MACHINE".
Places to lock → See "12.16 LOCKING".

7.3 TRANSPORTATION

LOADING AND UNLOADING

- Loading and unloading the machine always involves potential hazards. **EXTREME CAUTION SHOULD BE USED.**
When loading or unloading the machine, run the engine at low idling and travel at low speed.
- Perform loading and unloading on firm, level ground only. Maintain a safe distance from the edge of a road.
- **ALWAYS** block the wheels of the hauling vehicle and place blocks under both ramps before loading and unloading.
- **ALWAYS** use ramps of adequate strength. Be sure the ramps are wide and long enough to provide a safe loading slope.
- Be sure that the ramps are securely positioned and fastened, and that the two sides are at the same level as one another.
- Be sure the ramp surface is clean and free of grease, oil, ice and loose materials. Remove dirt from the machine tires.
- **NEVER** correct your steering on the ramps. If necessary, drive away from the ramps and climb again.
- After loading, block the machine tires and secure the machine with tie-downs.

Loading and unloading → See "13. TRANSPORTATION".

Tie-downs → See "13. TRANSPORTATION".

CORRECT

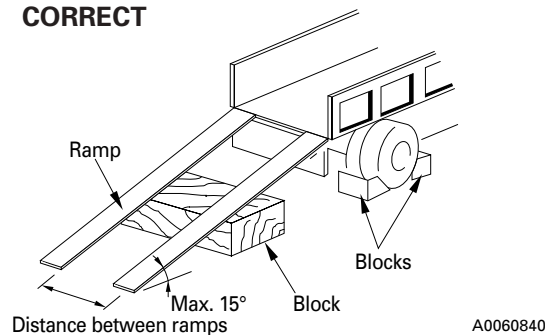

SHIPPING

- When shipping the machine on a hauling vehicle, obey all state and local laws governing the weight, width, and length of a load. Also obey all applicable traffic regulations.
- Determine the shipping route while taking into account the width, height and weight of the load.

7.4 BATTERY

BATTERY HAZARD PREVENTION

- Battery electrolyte contains sulfuric acid and can quickly burn the skin and eat holes in clothing. If you spill acid on yourself, immediately flush the area with water.
- Battery acid could cause blindness if splashed into the eyes. If acid gets into the eyes, flush them immediately with large quantities of water and see a doctor at once.
- If you accidentally drink acid, drink a large quantity of water or milk, beaten egg or vegetable oil. Call a doctor or poison prevention center immediately.
- When handling the battery, always wear safety glasses and rubber gloves. The electrolyte inside the battery may cause burns or loss of sight.
- Batteries generate hydrogen gas. Hydrogen gas is very **EXPLOSIVE**, and is easily ignited with a small spark or flame.
- Before working with batteries, stop the engine and turn the starting switch to the OFF position.
- Avoid short-circuiting the battery terminals through accidental contact with metallic objects, such as tools, across the terminals.
- When removing or installing, check which is the positive (+) terminal and negative (-) terminal.
- Tighten the battery cap securely.
- Tighten the battery terminals securely. Loosened terminals can generate sparks and lead to an explosion.

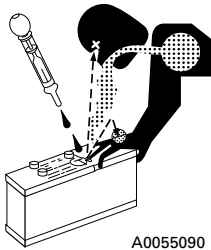

STARTING WITH BOOSTER CABLES

- **ALWAYS** wear safety glasses or goggles when starting the machine with booster cables.
- When starting from another machine, do not allow the two machines to touch.
- Be sure to connect the positive (+) cable first when installing the booster cables. Disconnect the ground or negative (-) cable first when removing them.
- If any tool touches between the positive (+) terminal and the chassis, it will cause sparks. This is dangerous, so be sure to work carefully.
- Connect the batteries in parallel: positive to positive and negative to negative.
- When connecting the ground cable to the frame of the machine to be started, be sure to connect it as far as possible from the battery.

Starting with booster cables → See "16. TROUBLESHOOTING".

INCORRECT

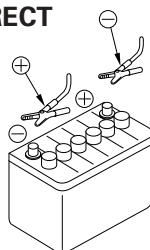

7.5 TOWING

WHEN TOWING, FIX WIRE TO HITCH PIN

- Towing in the wrong way may lead to serious personal injury or damage.
- When using another machine to tow this machine, use a wire rope with ample strength for the weight of this machine.
- Never tow a machine on a slope.
- Do not use any towing rope that has kinks or is twisted.
- Do not stand astride the towing cable or wire rope.
- When connecting a machine that is to be towed, do not let any one come between the towing machine and the machine that is being towed.
- Set the coupling of the machine being towed in a straight line with the towing portion of the machine, and secure it in position.

Towing method → See "16. TROUBLESHOOTING".

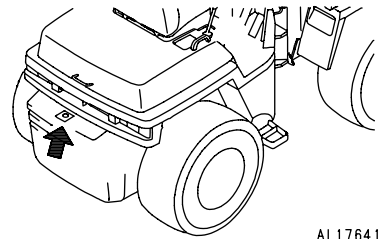

AL176410

8. PRECAUTIONS FOR MAINTENANCE

⚠ WARNING: Failure to follow these safety precautions may lead to a serious accident.

8.1 BEFORE CARRYING OUT MAINTENANCE

WARNING TAG

- If others start the engine or operate the controls while you are performing service or lubrication, you could suffer serious injury or death.
- ALWAYS attach the WARNING TAG to the control lever in the operator's cab to alert others that you are working on the machine. Attach additional warning tags around the machine, if necessary.
- These tags are available from your Komatsu distributor. (Part No. 09963-03000)

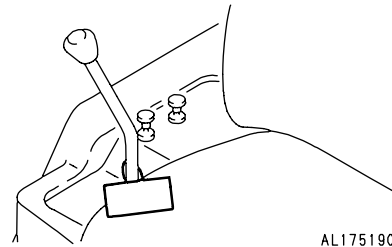

PROPER TOOLS

- Use only tools suited to the task. Using damaged, low quality, faulty, or makeshift tools could cause personal injury.
Tools → See "21.1 INTRODUCTION OF NECESSARY TOOLS".



PERIODIC REPLACEMENT OF SAFETY CRITICAL PARTS

- Replace the following fire-related components periodically:

Fuel system:	Fuel hose, spilling hose, and fuel tube cap
Hydraulic system:	Pump outlet hose
- Replace these components periodically with new ones, regardless of whether or not they appear to be defective. These components deteriorate over time.
- Replace or repair any such components if any defect is found, even though they have not reached the time specified.

Replacement of safety critical components → See "22. PERIODIC REPLACEMENT OF SAFETY CRITICAL PARTS".

STOP THE ENGINE BEFORE CARRYING OUT INSPECTION AND MAINTENANCE

- When carrying out inspection and maintenance, always stop on a flat firm road surface where there is no danger of falling rocks, landslides, or floods. Then lower the work equipment to the ground, set the safety lock levers to the LOCK position, and stop the engine.
- If it is necessary to run the engine when carrying out maintenance, such as when cleaning the inside of the radiator, place the safety lock lever at the LOCK position and carry out the operation with two workers.
- One worker should sit in the operator's seat so that he can stop the engine immediately if necessary. He should also be extremely careful not to touch any lever by mistake. Touch the levers only when they have to be operated.
- The worker carrying out the maintenance should be extremely careful not to touch or get caught in the moving parts.

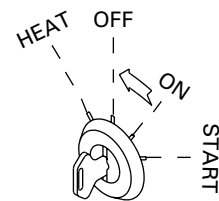

AM089160

LOCK FRONT AND REAR FRAMES

Lock the front and rear frames with the safety bar.

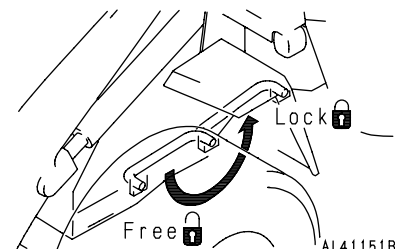

AL41151B

WORK EQUIPMENT SUPPORT

When carrying out inspection and maintenance with the work equipment raised, fit a stand under the lift arm securely to prevent the work equipment from coming down. In addition, set the work equipment control levers to the HOLD position and lock with the safety lock.

RULES TO FOLLOW WHEN ADDING FUEL OR OIL

- Always stop the engine before adding fuel or oil.
- Spilled fuel and oil may cause you to slip, so always wipe it up immediately.
- Always tighten the cap of the fuel and oil fillers securely.
- Never use fuel for washing any parts.
- Always add fuel and oil in a well-ventilated place.



A0055020



A0055030



A0055040

RADIATOR WATER LEVEL

- When checking the water level, stop the engine and wait for the engine and regulator to cool down, then check the water level in the sub-tank.
- When adding water, add water through the sub-tank.
- Loosen the cap slowly to release the internal pressure before removing the cap.

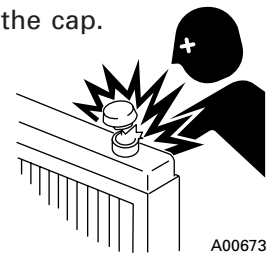

A0067380

USE OF LIGHTING

- When checking fuel, oil, coolant, or battery electrolyte, always use lighting with anti-explosion specifications. If such lighting equipment is not used, there is danger of explosion.



A0055160

DO NOT STAND ON ENGINE HOOD

Never climb on to the engine hood. There is danger that you will slip and fall.

PREVENTION OF FIRE

Carrying out maintenance involves handling objects such as fuel and batteries which may cause a fire. To prevent fire, do as follows.

- Keep fuel and other flammable oil and fluids well away from fire.
- Always use a non-flammable oil for washing parts.
- Put out any fires that may cause the fuel or oil to ignite.
- Always have a fire extinguisher or other fire-fighting equipment available.
- Do not smoke when carrying out inspection and maintenance operations.

8.2 DURING MAINTENANCE

PERSONNEL

- Only authorized personnel can service and repair the machine. Extra precaution should be used when grinding, welding, and using a sledge-hammer.

ATTACHMENTS

- Place attachments that have been removed from the machine in a safe place so that they do not fall. If they fall on you or others, serious injury could result.



A0055130

WORK UNDER THE MACHINE

- Always lower all movable work equipment to the ground or to their lowest position before performing service or repairs under the machine.
- Always block the tires of the machine securely.
- Never work under the machine if the machine is poorly supported.



A0055140

KEEP THE MACHINE CLEAN

- Spilled oil or grease, or scattered tools or broken pieces are dangerous because they may cause you to slip or trip.
Always keep your machine clean and tidy.
- If water gets into the electrical system, there is danger that the machine may not move or may move unexpectedly.
Do not use water or steam to clean the sensors, connectors, or the inside of the operator's compartment.

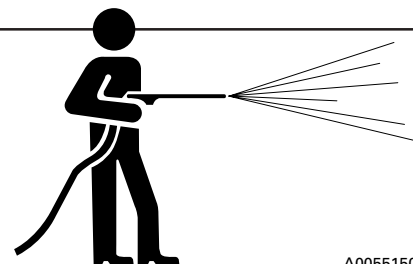

A0055150

PRECAUTIONS WITH BATTERY

- When repairing the electrical system or when carrying out electrical welding, remove the negative (-) terminal of the battery to stop the flow of current.



A0055170

HANDLING HIGH-PRESSURE HOSES

- Do not bend high-pressure hoses or hit them with hard objects. Do not use any bent or cracked piping, tubes or hoses. They may burst during use.
- Always repair any loose or broken fuel hoses or oil hoses. If fuel or oil leaks, it may cause a fire.

PRECAUTIONS WITH HIGH PRESSURE OIL

- Do not forget that the work equipment circuits are always under pressure.
- Do not add oil, drain oil, or carry out maintenance or inspection before completely releasing the internal pressure.
- If oil is leaking under high pressure from small holes, it is dangerous if the jet of high-pressure oil hits your skin or enters your eyes. Always wear safety glasses and thick gloves, and use a piece of cardboard or a sheet of wood to check for oil leakage.
- If you are hit by a jet of high-pressure oil, consult a doctor immediately for medical attention.



A0055180



A0055190

PRECAUTIONS WHEN CARRYING OUT MAINTENANCE AT HIGH TEMPERATURE OR HIGH PRESSURE

- Immediately after stopping operations, the engine cooling water and oil at all parts is at high temperature and under high pressure. In this condition, if the cap is removed, or the oil or water are drained, or the filters are replaced, this may result in burns or other injury. Wait for the temperature to go down, then carry out the inspection and maintenance in accordance with the procedures given in this manual.

Clean inside or cooling system, check lubricating oil level, add oil → see “24.2 WHEN REQUIRED”.

Check cooling water level, engine oil pan, oil level, brake oil level, add oil or water → see “24.3 CHECK BEFORE STARTING”.

Checking hydraulic oil level, adding oil → see “24.5 PERIODIC MAINTENANCE”.

Changing oil, replacing filters → see “24.6 – 8 PERIODIC MAINTENANCE”.

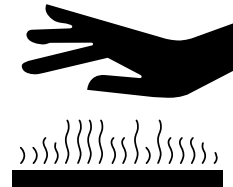

A0055050

ROTATING FAN AND BELT

- Keep away from rotating parts and be careful not to let anything get caught in them.
- If your body or tools touch the fan blades or fan belt, they may be cut off or sent flying, so never touch any rotating parts.

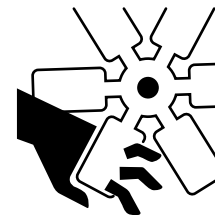

A0063830

WHEN OPERATING WITH CHASSIS RAISED

- When carrying out operations with the work equipment or chassis raised, lock the front and rear frames with the safety lock, always place the control levers in the HOLD position, then lock the control levers with the safety lock, and block the work equipment and chassis.
- Always fit blocks under the wheels on the opposite side when jacking up the machine. After jacking up the machine, set blocks under it to hold it in position.

TIRE MAINTENANCE

Disassembly, repair, and assembly of tires requires specialist equipment and skill, so please ask your specialist tire repair shop to carry out repairs.

WASTE MATERIALS

- Never dump waste oil in a sewer system, rivers, etc.
- Always put oil drained from your machine in containers. Never drain oil directly on the ground.
- Obey appropriate laws and regulations when disposing of harmful objects such as oil, fuel, coolant, solvent, filters, batteries, and others.

INCORRECT

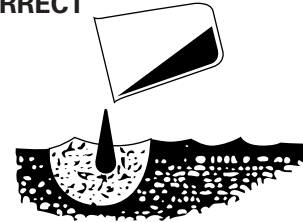

A0055220

8.3 TIRES

HANDLING TIRES

If tires are not used under the specified conditions, they may overheat and burst or be cut and burst by sharp stones on rough road surfaces. This may lead to serious injury or damage.

To maintain safety, always keep to the following conditions.

- Inflate the tires to the specified pressure. Abnormal heat is generated particularly when the inflation pressure is too low.

Suitable inflation pressure → See "12.17 HANDLING THE TIRES".

- Avoid overloading.

Suitable load → Normal load for bucket:

WA20	4.4 kN (450 kgf)
WA30	6.3 kN (640 kgf)
WA40	7.8 kN (800 kgf)
WA50	9.4 kN (960 kgf)

- Use the specified tires.

The values given in this manual for the tire inflation pressure and permissible speed are general values. The actual values may differ depending on the type of tire and the condition under which they are used. For details, please contact your Komatsu distributor or tire maker.

If the tire is heated when installed to the wheel, flammable gas is produced. If this catches fire, the tire may explode and cause serious injury or damage. Unlike when a tire is punctured and burst, if a tire explodes, it produces a highly destructive force, so the following operations are strictly prohibited when the tire is installed to the wheel.

- Welding of the rim
- Lighting fires or carrying out welding operations near the wheel or tire

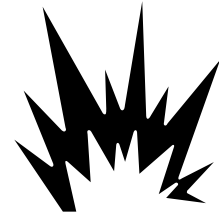

A0055110

If you do not understand the proper procedure for carrying out maintenance or replacement of the wheel or tire, and you use the wrong method, the wheel or tire may burst and cause serious injury or damage. When carrying out such maintenance, please consult your Komatsu distributor or tire maker.

STORING TIRES AFTER REMOVAL

- As a basic rule, store the tires in a warehouse which unauthorized persons cannot enter. If the tires are stored outside, always erect a fence around the tires and put up “No Entry” and other warning signs that even young children can understand.
- Stand the tire on level ground, and block it securely so that it cannot roll or fall over.
- If the tire should fall over, get out of the way quickly. The tires for construction equipment are extremely heavy, so trying to hold the tire may lead to serious injury.

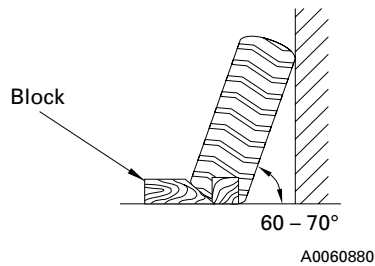

9. POSITION FOR ATTACHING SAFETY LABELS

Always keep these labels clean. If they are lost or damaged, attach them again or replace them with a new label.

There are other labels in addition to the safety labels listed as follows, so handle them in the same way.

Safety labels may be available in languages other than English. To find out what labels are available, contact your Komatsu distributor.

9.1 POSITION FOR ATTACHING SAFETY LABELS

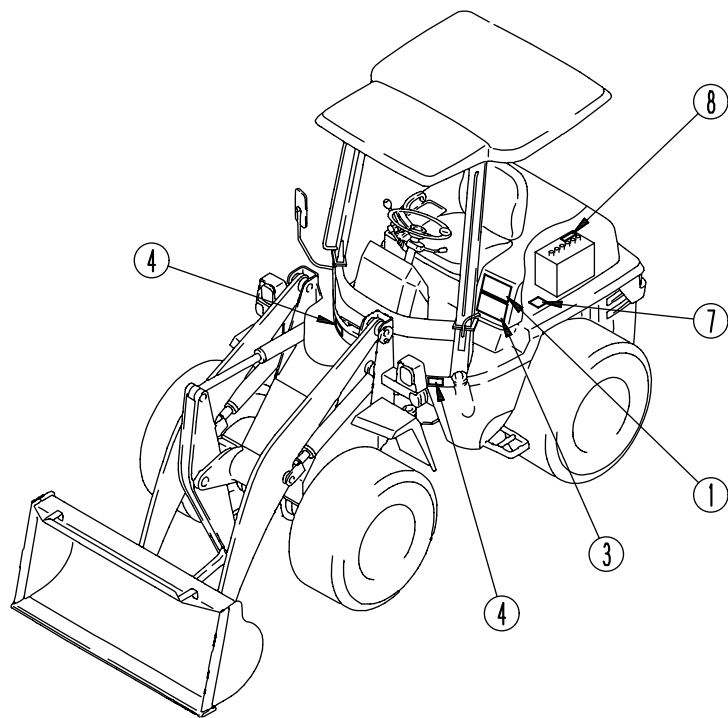

AL402020

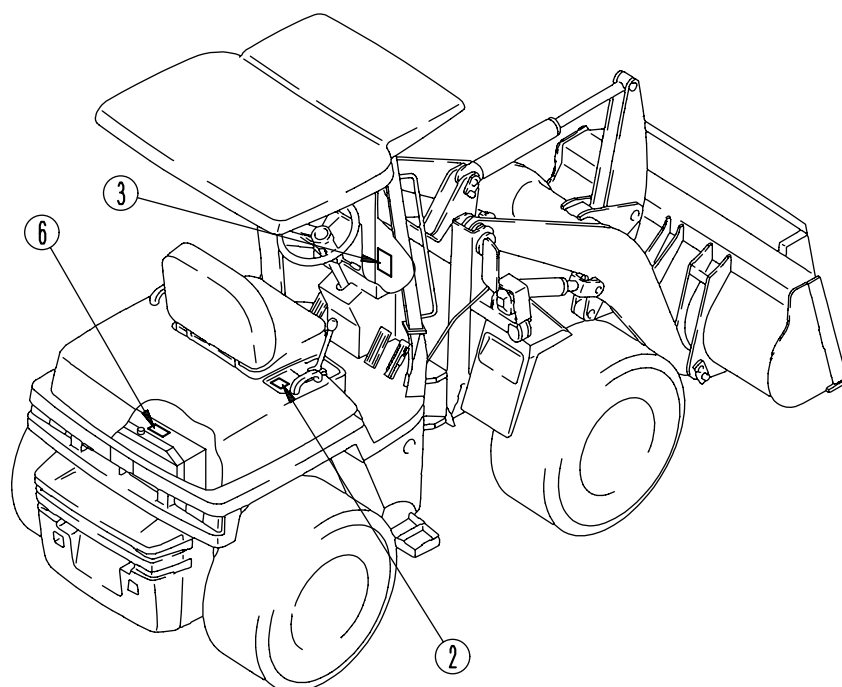

AL402030

1. Precautions before starting

WARNING

BEFORE OPERATION, INSPECTION AND/OR MAINTENANCE, BE SURE TO READ CAREFULLY THE APPROPRIATE MANUALS AND WARNING LABELS TO PERFORM THE OPERATION ACCORDING TO THEIR INSTRUCTIONS AND WARNINGS. FAILURE TO FOLLOW THESE INSTRUCTIONS AND WARNINGS MAY RESULT IN SERIOUS INJURY OR DEATH.

KEEP THE MANUALS NEAR THE MACHINE OPERATOR. FOR REPLACEMENT OF THEM WITH NEW ONES, CONTACT YOUR NEAREST KOMATSU AGENT.

2. Precautions for safety lock lever

WARNING

BEFORE LEAVING THE OPERATOR'S SEAT, BE SURE TO LOWER THE WORK EQUIPMENT TO THE GROUND AND SET THE SAFETY LOCK KNOB (LOCATED AT RIGHT OF THE OPERATOR'S SEAT) IN THE "LOCK" POSITION.

FAILURE TO OBSERVE THE ABOVE MAY RESULT IN SERIOUS INJURY OR DEATH CAUSED BY UNEXPECTED MOVEMENT OF THE MACHINE DUE TO ACCIDENTAL CONTACT WITH THE UNLOCKED OPERATING LEVER.

3. Precautions when traveling in reverse

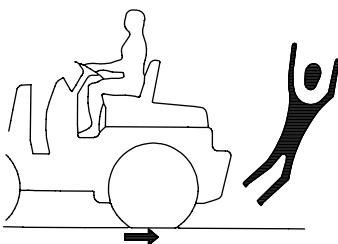
WARNING

BEFORE OPERATING THE MACHINE OR ITS WORK EQUIPMENT, BE SURE TO OBSERVE THE FOLLOWING POINTS. FAILURE TO DO SO MAY RESULT IN SERIOUS INJURY OR DEATH.

- SOUND A HORN TO ALERT NEARBY PEOPLE.
- MAKE SURE THAT NO ONE IS PRESENT ON OR AROUND THE MACHINE.
- PLACE GUARD WHERE VISIBILITY IS POOR. BE SURE TO CARRY OUT THE ABOVE EVEN IF THE MACHINE IS EQUIPPED WITH BACKUP ALARM AND MIRRORS.

4. Do not enter

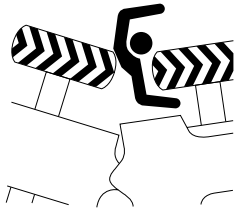

! DANGER

CRUSH HAZARD. CAN CAUSE SERVICE INJURY OR DEATH. WHEN MACHINE IS BEING OPERATED, NEVER PLACE YOURSELF IN ARTICULATED AREA OF MACHINE.

5. Precautions for safety bar

! WARNING

TRANSPORTATION AND LIFTING OF THE MACHINE WITHOUT LOCKING THE SAFETY BAR MAY CAUSE THE MACHINE BODY TO TURN UNEXPECTEDLY, RESULTING IN SERIOUS INJURY TO A NEARBY PERSON OR HIS DEATH.

- WHEN TRANSPORTING OR LIFTING THE MACHINE, BE SURE TO LOCK THE SAFETY BAR.
- WHEN SERVICING THE MACHINE, LOCK THE SAFETY BAR AS REQUIRED.

7. Precautions when handling battery cable

! WARNING

WHEN CONNECTING/ DISCONNECTING THE BATTERY CABLE AND USING THE BOOSTER CABLE, FOLLOW THE APPROPRIATE INSTRUCTION MANUAL. IMPROPER HANDLING OF THE CABLES MAY RESULT IN INJURY.

6. Precautions when coolant is at high temperature

! WARNING

TAKE PRECAUTIONS AGAINST HOT COOLING WATER.

IN ORDER TO PREVENT HOT COOLING WATER FROM BLOWING OUT, OBSERVE THE FOLLOWING PROCEDURE;

- STOP THE ENGINE.
- WAIT UNTIL THE WATER COOLS.
- SLOWLY TURN THE CAP TO RELEASE THE PRESSURE BEFORE REMOVING THE CAP.

8. Precautions when handling battery (235-53-31360)

危険！ バッテリーの取扱いにご注意

取扱いを誤ると引火爆発することがあります。

- ショートやスパークさせたり、タバコ等の火気は危険です。
- 充電や使用は通風のよいところで行って下さい。
- ブースタケーブル使用時には危険のないように取扱い下さい。バッテリー液（希硫酸）で失明ややけどをすることがあります。
- 目・皮膚・衣服についたときは直ちに多量の水で洗って下さい。
- なお、目に入ったときは水洗い後、医師の治療をうけて下さい。

DANGER KEEP SPARKS, FLAME, CIGARETTES AWAY.
ELOIGNEZ LES ETINCELLES, FLAMME, CIGARETTES

Please request part number 362-V11-4121 for safety labels (1 – 7).

MEMO

OPERATION

10. GENERAL VIEW

10.1 GENERAL VIEW OF MACHINE

If directions are indicated in this section, they refer to the directions shown by the arrows in the diagram below.

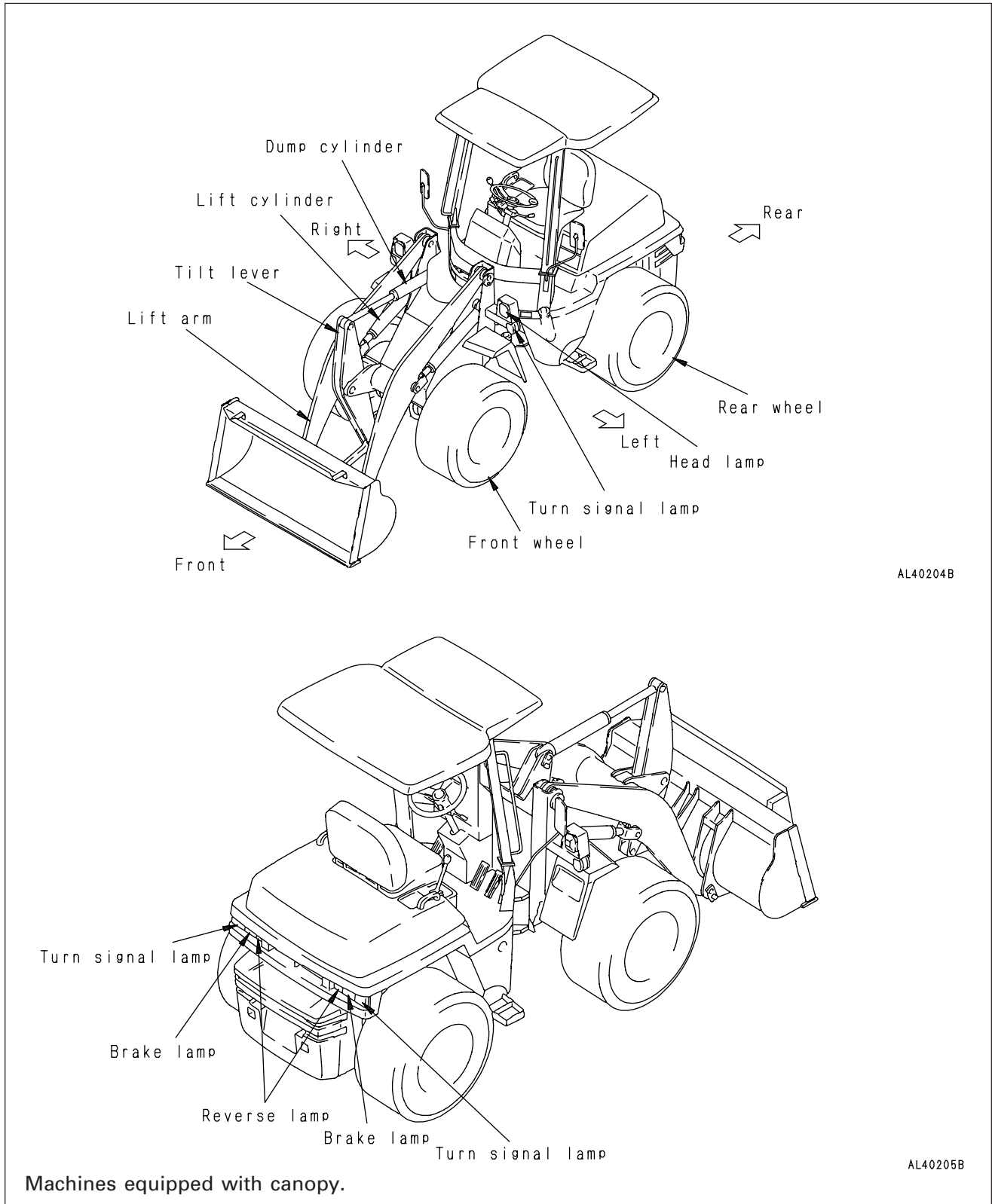

10.2 GENERAL VIEW OF CONTROLS AND GAUGES

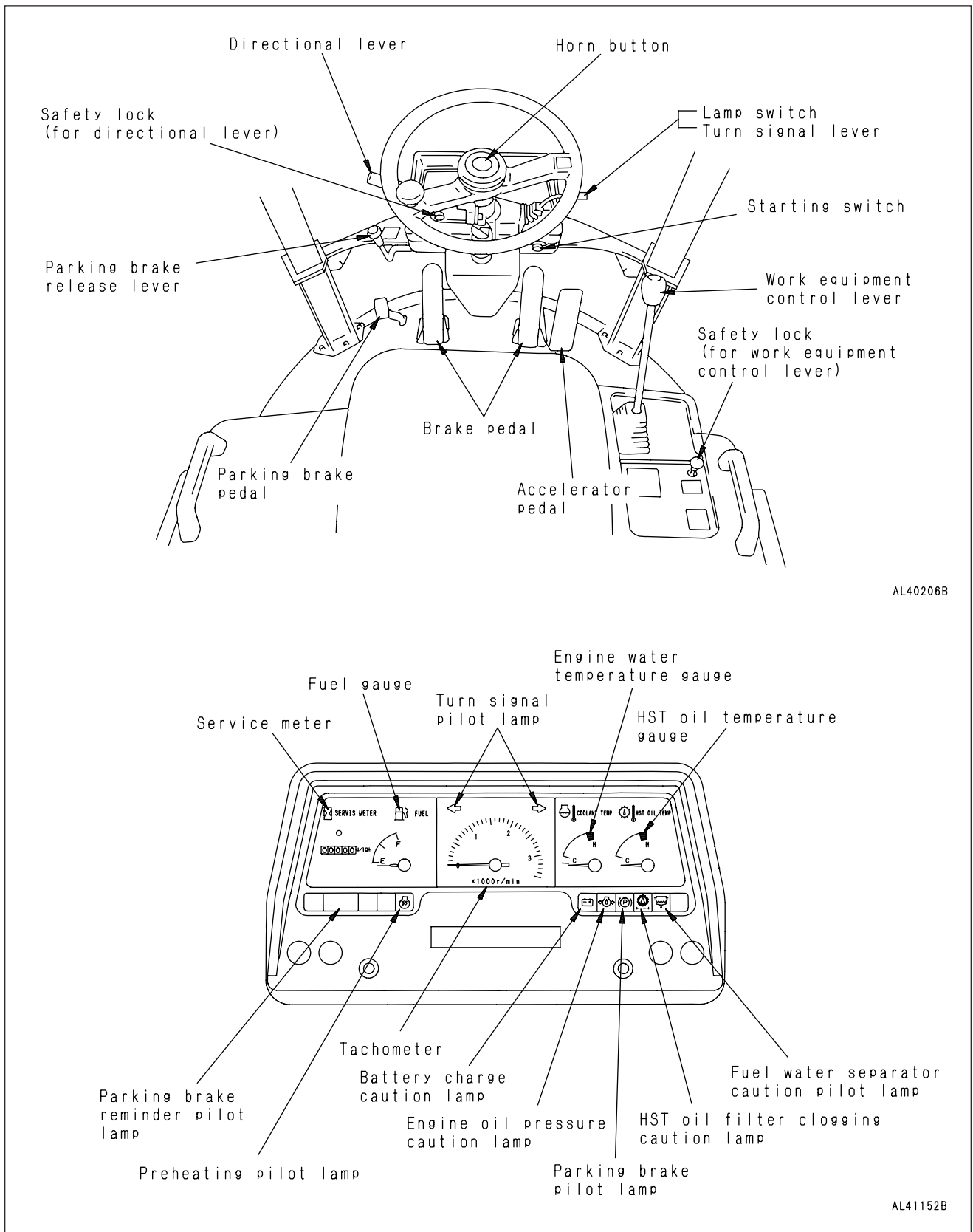

11. EXPLANATION OF COMPONENTS

The following is an explanation of the devices needed for operating the machine.

To carry out suitable operations correctly and safely, it is important to understand fully the methods of operating the equipment and the meanings of the displays.

11.1 METER, LAMPS

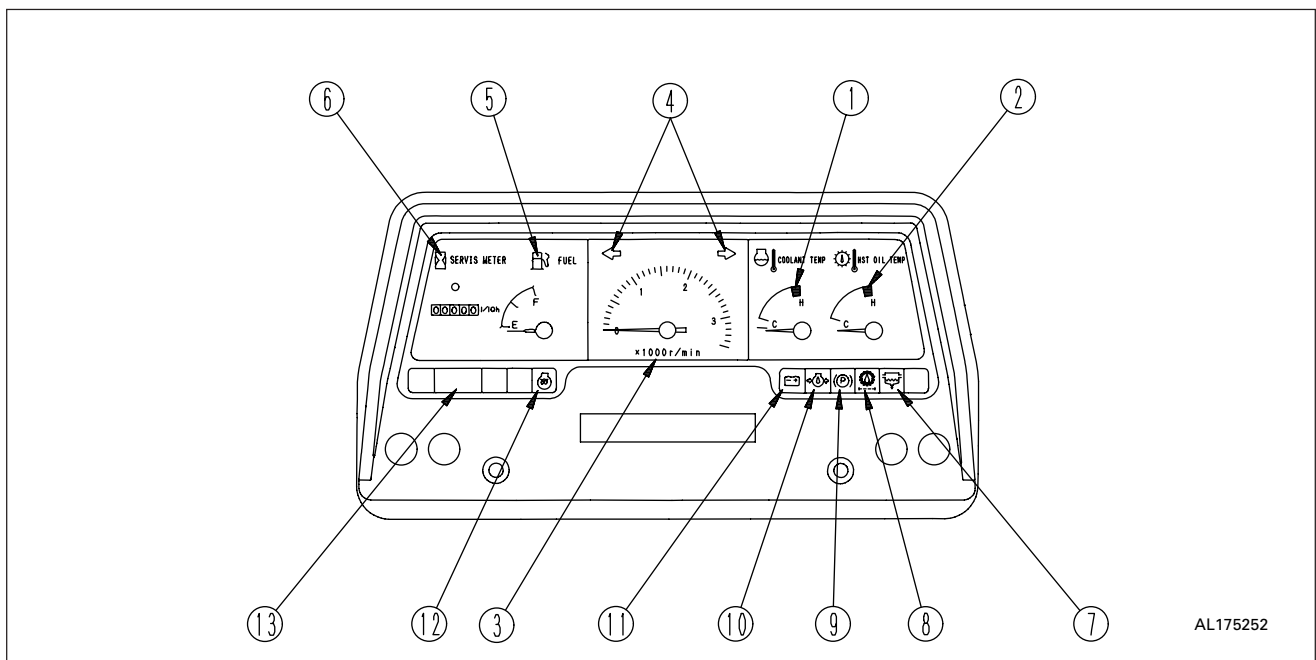

AL175252

1. ENGINE WATER TEMPERATURE GAUGE

This gauge indicates the engine cooling water temperature.

When the pointer of the temperature gauge shows the white range, the oil temperature is normal.

When the pointer enters the red range, stop the machine immediately, and run the engine with no load at midrange speed until the oil temperature drops to the normal value.

NOTICE

If the engine water temperature gauge enters the red range frequently, check and clean the radiator fins.

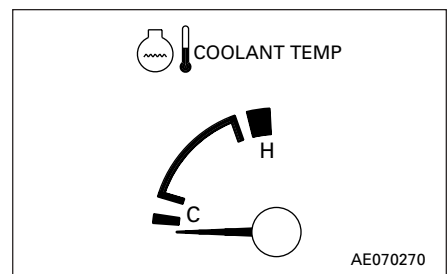

AE070270

2. HST OIL TEMPERATURE GAUGE

This gauge indicates HST oil temperature.

When the pointer of the gauge shows the white range, the oil is normal.

When the pointer enters the red range, stop the machine immediately, and run the engine with no load at midrange speed until the oil temperature drops to the normal value.

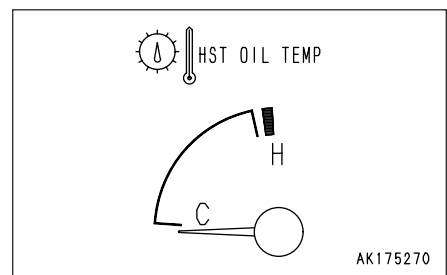

AK175270

3. TACHOMETER

This indicates the revolution of engine. (graduated in 1000 rev.)

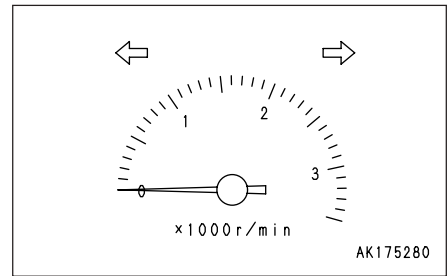

4. TURN SIGNAL PILOT LAMP

When the turn signal lamp flashes, the pilot lamp also flashes.

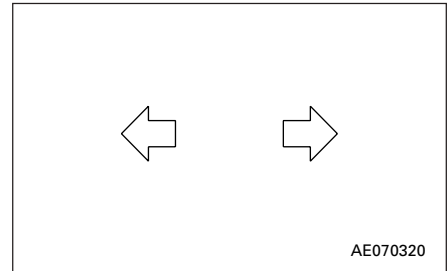

5. FUEL GAUGE

This gauge indicates the amount of fuel in the fuel tank.

E: Tank is max. 3.5 l (0.92 US gal, 0.77 UK gal)

F: Tank is FULL

If the fuel gauge indicates E during operation, check and supply fuel.

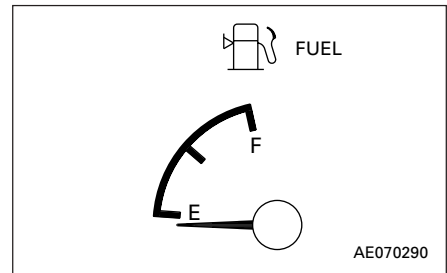

6. SERVICE METER

This meter shows the total operation hours of the machine.

The service advances while the engine is running - even if the machine is not traveling.

While the engine is running, green pilot lam on the service meter flashes to show the service meter advances.

The service meter progresses by 1 when the engine is operated for one hour, regardless of the engine speed.

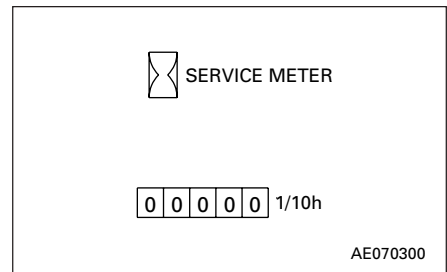

7. FUEL WATER SEPARATOR CAUTION PILOT LAMP (WA30, 40, 50)

This lamp indicates the water in fuel water separator.

When lighting up in machine operating, drain the water in the separator.

For details, see "24.2 WHEN REQUIRED".

The WA20 also has the symbols used in the diagrams on the right, but this pilot lamp is not used.

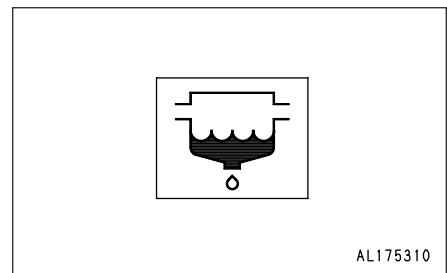

8. HST OIL FILTER CLOGGING CAUTION LAMP

This lamp indicates the end of life of HST oil filter.

When lighting up, change to the new filter.

This lamp tends to work when ambient temperature is low, however it is no problem when HST oil temperature gauge's pointer is in white range.

For details of method for HST oil filter element, see "24.7 EVERY 1000 HOURS SERVICE".

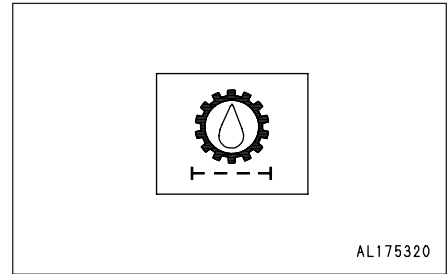
**9. PARKING BRAKE PILOT LAMP**

This lamp lights up when the parking brake is applied.

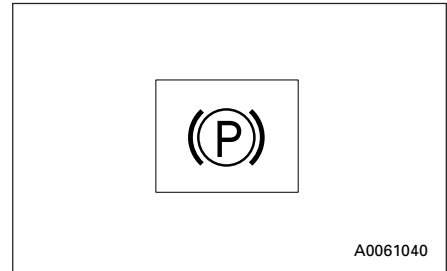
**10. ENGINE OIL PRESSURE CAUTION LAMP**

This lamp indicates lowering of the engine lubricating oil pressure.

It is kept turned off during operation if the oil pressure is normal.

If the engine oil pressure lowers during operation, this lamp lights up. In this case, stop the engine immediately and check the engine oil level.

If this lamp does not light up when the starting switch is turned on, the bulb is broken. Replace the bulb in this case.

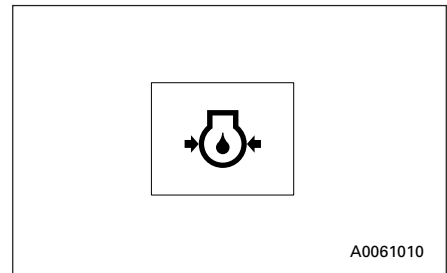
**11. BATTERY CHARGE CAUTION LAMP**

This warns the operator that there is an abnormality in the charging system when the engine is running.

If it lights up, check the charging circuit.

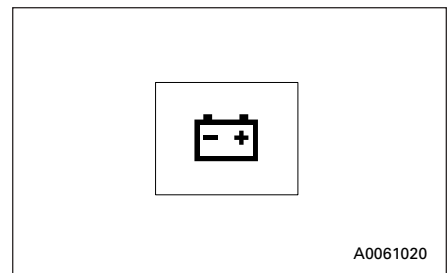

12. PREHEATING PILOT LAMP

This informs the operator that the glow plug is heated.

This lamp lights up when the starting switch is turned to the HEAT position, and goes out after 15 seconds.

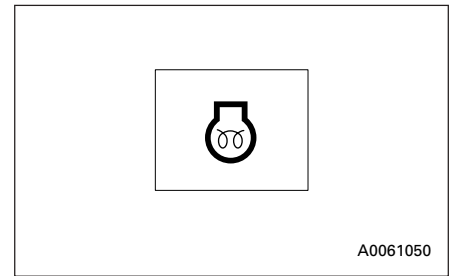
**13. PARKING BRAKE REMINDER PILOT LAMP**

After stopping engine, this lamp lights up with beep when the parking brake is not applied.

Apply the brake when lighting up.

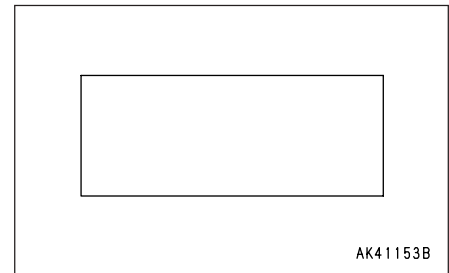

11.2 SWITCHES

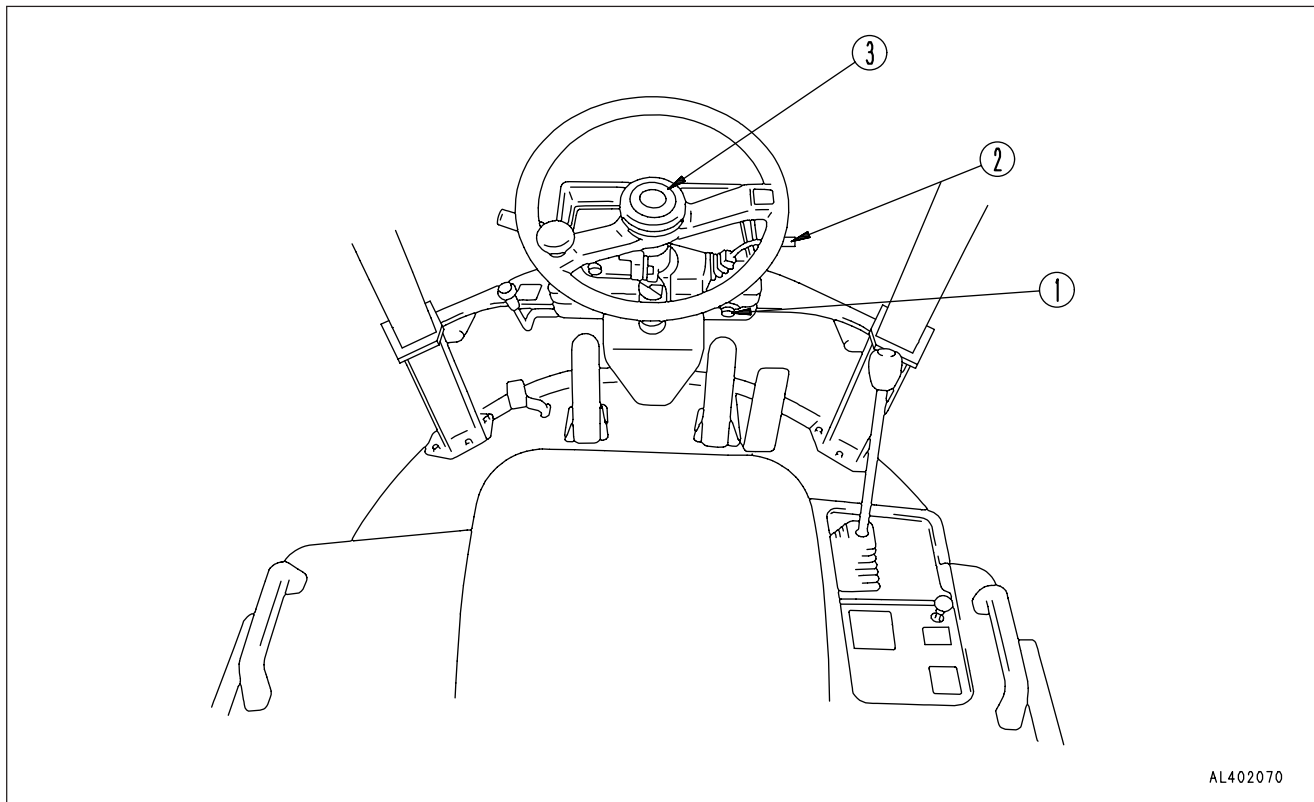

AL402070

1. STARTING SWITCH

This switch is used to start or stop the engine.

OFF position

The key can be inserted or withdrawn. The switches for the electric system are all turned off and the engine is stopped.

ON position

Electric current flows in the charging and lamp circuits.

Keep the starting switch key at the ON position while the engine is running.

START position

This is the engine-start position. Keep the key at this position during cranking. Immediately after starting the engine, release the key which will automatically return to the ON position.

HEAT (preheat) position

When starting the engine in winter, set the key to this position. When the key is set to the HEAT position, the pre-heating monitor lights up. Keep the key at this position until the monitor lamp goes off. Immediately after the pre-heating monitor goes off, release the key. The key automatically returns to the OFF position. Then, start the engine by turning the key to the START position.

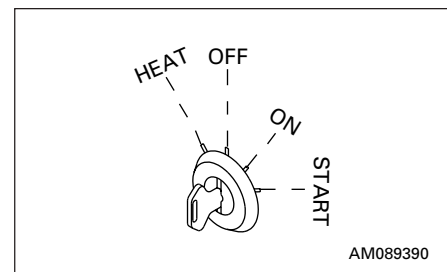



AM089390

REMARK

When the key is turned to the ON position, all the pilot lamps except the preheating pilot lamp and parking brake reminder pilot lamp light up, so it is possible to check if the bulbs are blown. When the engine is running, all the pilot lamps except the parking brake pilot lamp go out. (When the parking brake is still applied)

2. LAMP SWITCH

This is used to light up the head lamps, side clearance lamps, tail lamps, and instrument panel lighting.

- ① OFF
- ②  position: Side clearance lamp, tail lamps, and gauge lighting light up
- ③  position: Head lamps light up in addition to lamps at  position

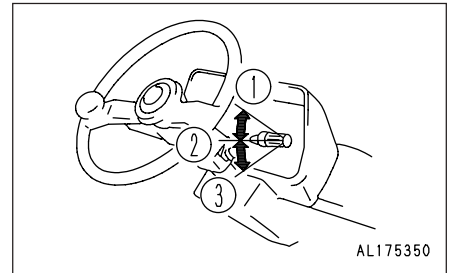
**REMARK**

The lamp switch can be operated regardless of the position of the lever.

2. TURN SIGNAL LEVER

This lever operates the turn signal lamps.

- ① LEFT TURN: Push lever FORWARD.
- ② RIGHT TURN: Pull lever BACK.

REMARK

- When the lever is operated, the turn signal pilot lamp will also light up.
- When the steering wheel is turned to the neutral position, the turn signal lever will not return automatically to OFF. Return the lever to OFF manually.

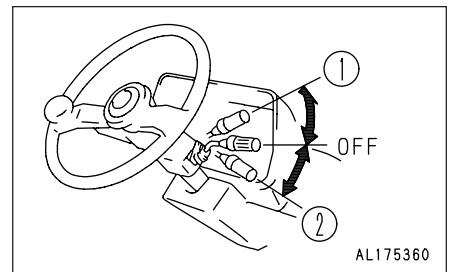
**3. HORN BUTTON**

When the button in the center of the steering wheel is pressed, the horn will sound.

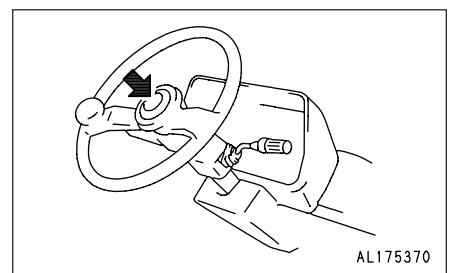

11.3 CONTROL LEVERS, PEDALS

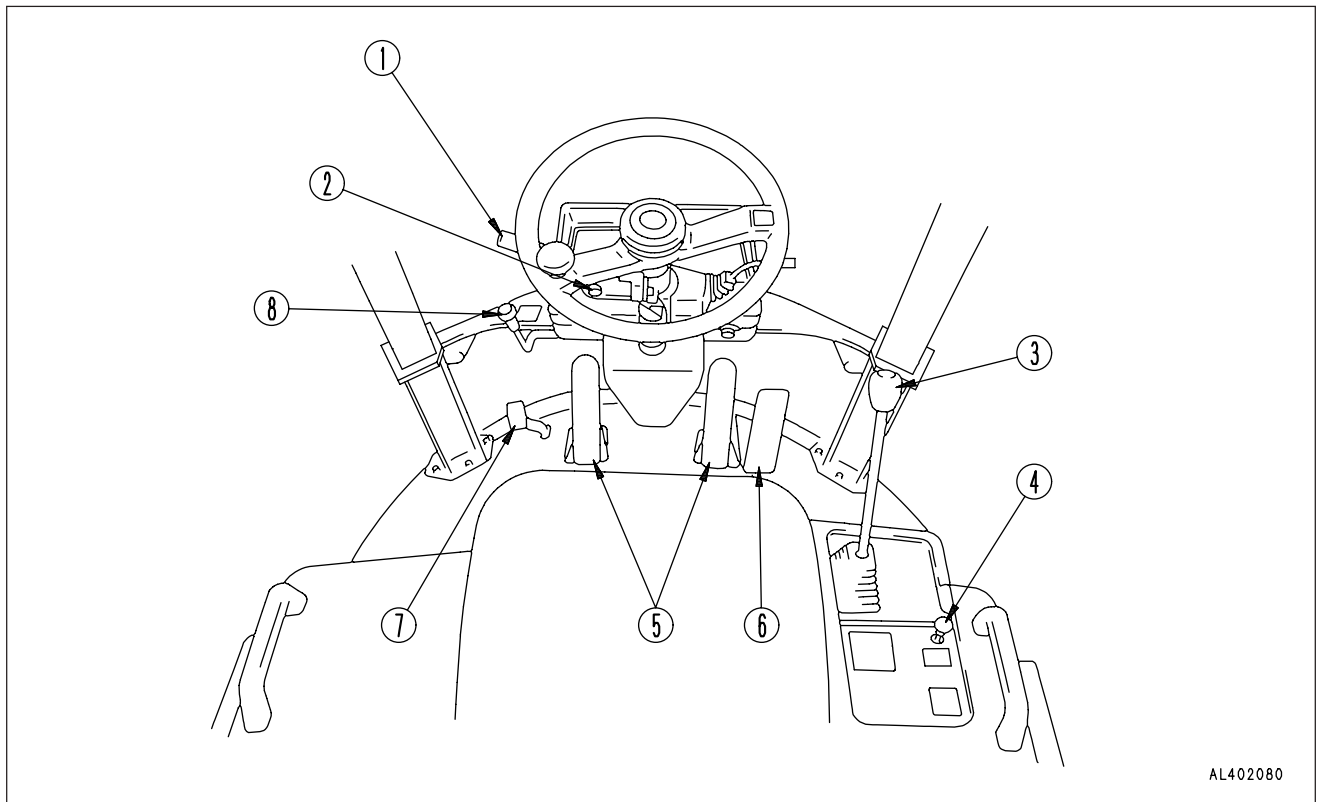

AL402080

1. DIRECTIONAL LEVER

This lever is used to change the direction of travel of the machine.

The engine cannot be started if the directional lever is not at N (neutral).

- Position ① : Forward
- Position N : Neutral
- Position ② : Reverse

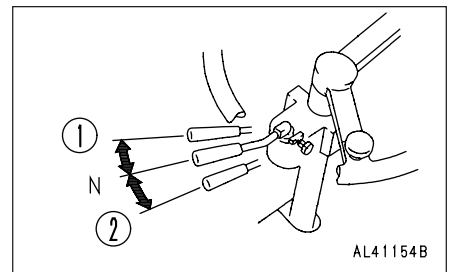

AL41154B

2. SAFETY LOCK (for directional lever)

⚠ WARNING



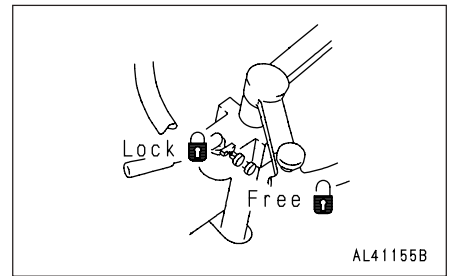



- When leaving the operator's compartment, set the safety lock securely to the LOCK position. If the directional lever is not locked, and this is touched by mistake, this may lead to a serious accident.
- If the safety lock is not placed securely in the LOCK position, the directional lever may not be properly locked. Check that the situation is as shown in the diagram.
- When parking the machine or carrying out maintenance, always lower the bucket to the ground and apply the lock.



This is used to lock the directional lever.
Push the knob to apply the lock.

3. WORK EQUIPMENT CONTROL LEVER

This lever is used to operate the lift arm and the bucket.

- ① RAISE ()
- ② HOLD (): The lift arm is kept in the same position.
- ③ LOWER ()
- ④ FLOAT (): The lift arm moves freely under external force.
- Ⓐ TILT ()
- Ⓑ DUMP ()

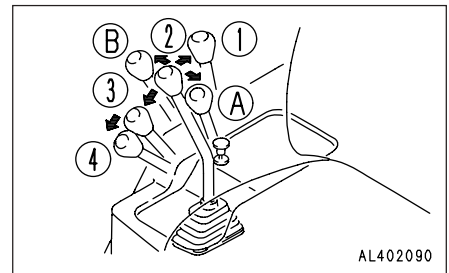

When the bucket is in the dump position, if the control lever is pulled to the TILT position the control lever will stop at this position and the bucket will continue to move.

When the bucket reaches the position set by the bucket positioner, the control lever is automatically returned to HOLD and the bucket stops.

If the lift arm is lowered from this point, the bucket will contact the ground horizontally. If it is not horizontal, carry out adjustments. For details, see "12.11 ADJUSTING WORK EQUIPMENT POSTURE".

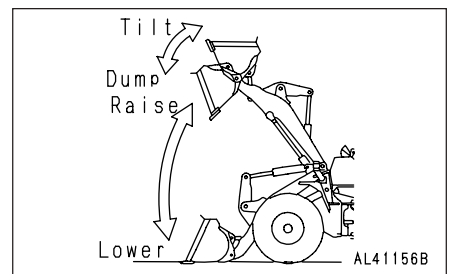

NOTICE

Do not use the FLOAT position when lowering the bucket.

4. SAFETY LOCK (for work equipment control lever)

WARNING

- When leaving the operator's compartment, set the safety lock securely to the **LOCK** position. If the control lever are not locked, and they are touched by mistake, this may lead to a serious accident.
- If the safety lock is not placed securely in the **LOCK** position, the control lever may not be properly locked. Check that the situation is as shown in the diagram.
- When parking the machine or carrying out maintenance, always lower the bucket to the ground and apply the lock.

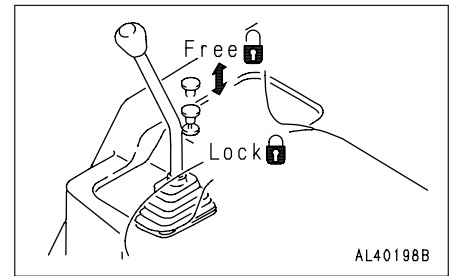

This is used to lock the work equipment lever.
Push the knob to apply the lock.

5. BRAKE PEDALS

WARNING

- Do not use the brake pedals repeatedly unless necessary.
- Do not put your foot on this pedal unless necessary.

There are brake pedals on both the left and right sides. Both the left and right pedals have the same function. When the brake pedal is depressed, the machine is stopped.

The brake pedal is interconnected with the HST inching valve, so if the brake pedal is depressed lightly, the HST pump returns in the neutral direction in accordance with the amount the pedal is depressed, and this gives a deceleration effect. If the pedal is depressed further, the wheel brake is actuated and the machine is stopped.

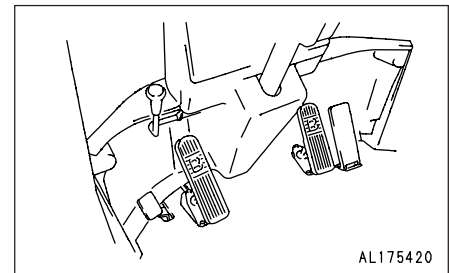

6. ACCELERATOR PEDAL

This pedal controls the engine speed and output.

The engine speed can be freely controlled between low idling and full speed.

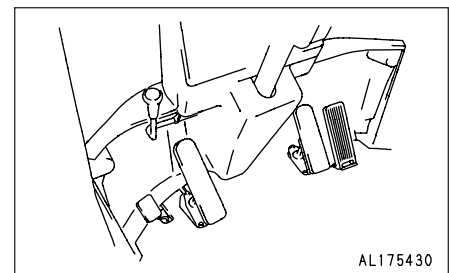

7. PARKING BRAKE PEDAL

⚠ WARNING

Always apply the parking brake when leaving the machine or parking it.

This lever operates the parking brake.

The brake is applied by depressing this pedal, and the parking brake pilot lamp lights up.

The machine does not start when the directional lever is operated with parking brake applied.

NOTICE

Never use the parking brake lever to apply the brakes when traveling, except in an emergency. Apply the parking brake only after the machine has stopped.

8. PARKING BRAKE RELEASE LEVER

This is used to release the parking brake. Pull the lever back to release the parking brake.

When the parking brake pedal returns to its original position, the parking brake is released.

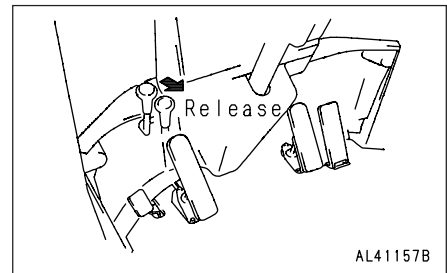
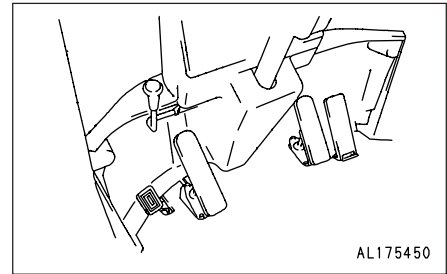

11.4 CAP WITH LOCK

The fuel tank filler port is equipped with locks.
Open and close the cap lock as follows.
Use the starting key to open and close the cap.

11.4.1 METHOD OF OPENING AND CLOSING CAP WITH LOCK

TO OPEN THE CAP

1. Insert the key into the cap.
Insert the key as far as it will go. If the key is turned before it is inserted all the way, it may break.
2. Turn the key clockwise, align the match mark on the cap with the rotor groove, then remove the cap.

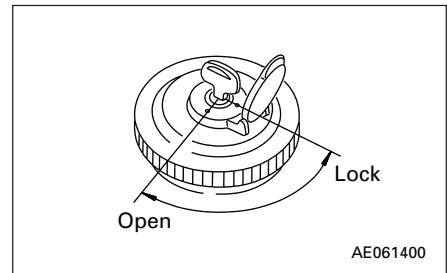

TO LOCK THE CAP

1. Turn the cap into place.
2. Turn the key counterclockwise and take the key out.

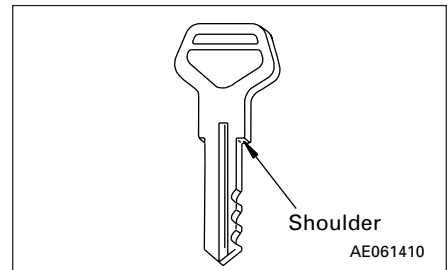

11.5 SAFETY BAR

⚠ WARNING

- Always use the safety bar for maintenance or when transporting the machine.
- Always remove the safety bar during normal travel operations.

The safety bar is used during maintenance or when transporting the machine. It locks the front frame and rear frame, and prevents the front and rear frames from bending.

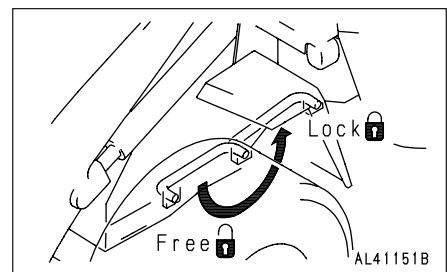

11.6 TILT HOOD

When the lever on grill ① is moved left, the tilt hood opens. When closing, move down the hood.

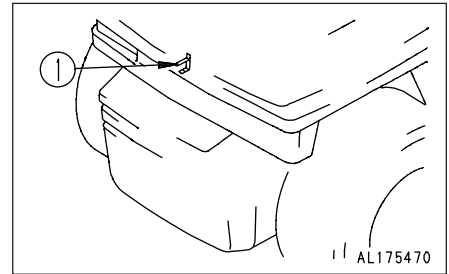

11.7 TOWING PIN

1. Align protrusion ① in the towing pin with groove ② in the counterweight, then insert and turn the pin 180°.

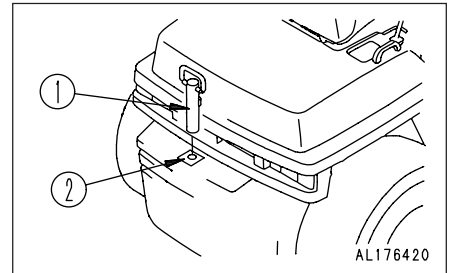

2. To prevent the towing pin from turning, bend the towing pin handle down and set it in position.

When removing the towing pin, carry out the above procedure in reverse.

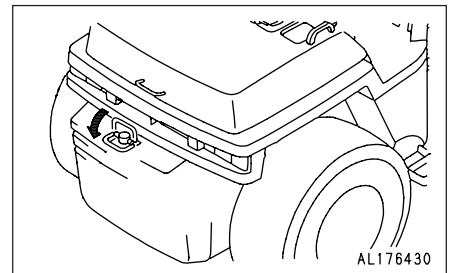

11.8 FUSE

NOTICE

Before replacing a fuse, be sure to turn off the starting switch.

The fuses protect the electrical equipment and wiring from burning out.

If the fuse becomes corroded, or white powder can be seen, or the fuse is loose in the fuse holder, replace the fuse.

Remove cover ①, then check or replace.

Replace a fuse with another of the same capacity.

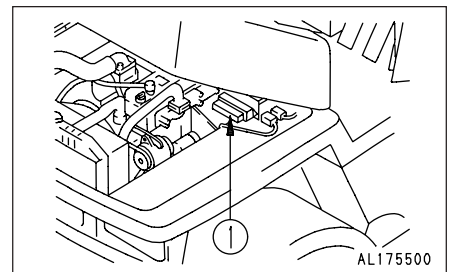

11.8.1 FUSE CAPACITY AND NAME OF CIRCUIT

No.	Fuse capacity	Name of circuit
①	10A	F – R control
②	20A	Reverse lamp, Horn, Turn signal pilot lamp Bucket positioner
③	30A	Engine stop solenoid
④	25A	Light switch
⑤	10A	Monitor panel
⑥	10A	Parking buzzer
⑦	20A	Heater (front window)
⑧	25A	Front wiper, Room lamp, Patrol light
⑨	20A	Working lamp, Radio
⑩	20A	Rear wiper

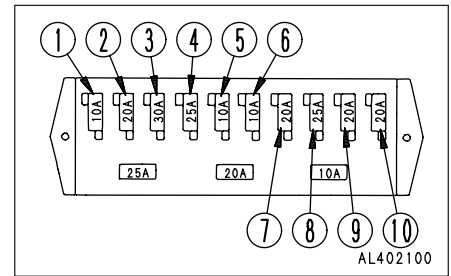

11.9 FUSIBLE LINK

If the power does not come on when the starting switch is turned ON, the fusible link may be blown, so open the tilt hood at the rear of the machine and check or replace it.

FUSIBLE LINK

65A: Chassis power source

REMARK

A fusible link is a large fuse wire installed in circuits where there is a large amount of electricity flowing. In the same way as a normal fuse, it acts to protect electrical component and wiring from burning out if any abnormal current should flow.

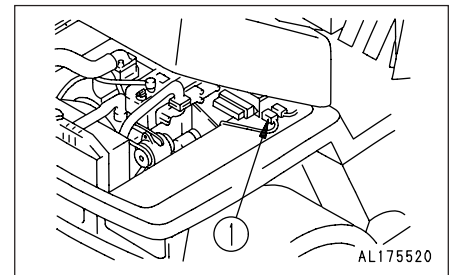

11.10 MANUAL POCKET

The operator's seat has a manual pocket in the back of backrest.

This manual should be kept in it for reference and periodical reviewing.

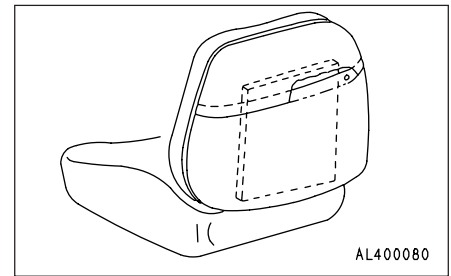

11.11 CONNECTORS

Connectors ① are in the right of the monitor panel. Use as power source.

⊕: Yellow

⊖: Black

Max. 10 A, 120 W

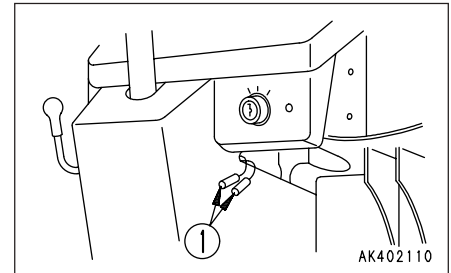

12. OPERATION

12.1 CHECK BEFORE STARTING ENGINE

12.1.1 WALK-AROUND CHECK

⚠ WARNING

Leakage of oil or fuel, or accumulation of flammable material around high temperature parts, such as the engine muffler, may cause fire.

Check carefully, and if any abnormality is found, repair it or contact your Komatsu distributor.

Before starting the engine, look around the machine and under the machine to check for loose nuts or bolts, or leakage of oil, fuel, or coolant, and check the condition of the work equipment and hydraulic system.

Check also for loose wiring, play, and collection of dust at places which reach high temperatures.

Always carry out the items in this section before starting the engine each day.

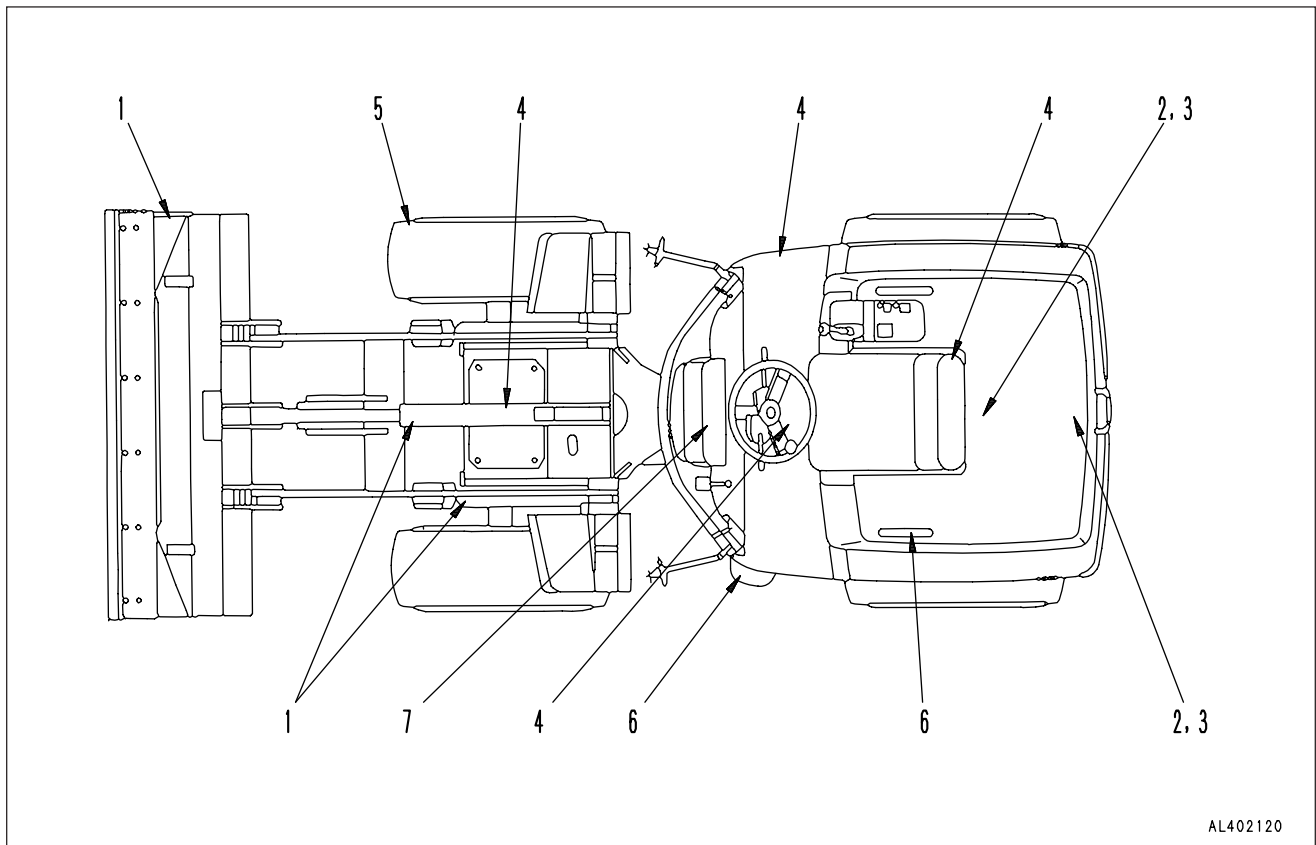

1. Check for damage, wear, play in work equipment, cylinders, linkage, hoses

Check that there are no cracks, excessive wear, or play in the work equipment, cylinders, linkage, or hoses. If any abnormality is found, repair it.

2. Remove dirt and dust from around engine, battery, radiator

Check if there is any dirt or dust accumulated around the engine or radiator. Check also if there is any flammable material (dead leaves, twigs, grass, etc.) accumulated around the battery or high temperature engine parts, such as the engine muffler. Remove all such dirt or flammable material.

3. Check for leakage of water or oil around engine

Check that there is no leakage of oil from the engine or leakage of water from the cooling system. If any abnormality is found, repair it.

4. Check for leakage of oil from HST transfer case, axle, hydraulic tank, hoses, joints

Check that there is no leakage of oil. If any abnormality is found, repair it.

5. Check for damage or wear to tires, loose mounting bolts

Check for cracks or peeling of the tires and for cracks or wear to the wheels. Tighten any loose wheel nuts. If any abnormality is found, repair or replace the part.

If any valve caps are missing, install new caps.

6. Check for damage to handrail and steps, loose bolts

Repair any damage and tighten any loose bolts.

7. Check for damage to lamps, gauges, loose bolts

Check that there is no damage to the gauges and monitor in the operator's cab. If any abnormality is found, replace the parts. Clean off any dirt on the surface.

8. Check seat belt and equipment

Check that there are no loose bolts on the equipment mounting the seat belt to the machine, and tighten if necessary.

Tightening torque: $24.5 \pm 4.9 \text{ N}\cdot\text{m}$ ($2.5 \pm 0.5 \text{ kgf}\cdot\text{m}$, $18.1 \pm 3.6 \text{ lbft}$)

If the belt is damaged or fluff is starting to form, or if there is any damage or deformation of the seat belt holders, replace the seat belt with a new part.

9. Check for loose bolts on ROPS

Check for any loose or damaged bolts. If any loose bolts are found tighten them to 98 to $123 \text{ N}\cdot\text{m}$ (10 to $12.5 \text{ kgf}\cdot\text{m}$, 72 to 90 lbft).

If any bolts are damaged, replace them with genuine Komatsu bolts.

12.1.2 CHECK BEFORE STARTING

Always carry out the items in this section before starting the engine each day.

CHECK BULBS OF PILOT LAMPS

1. Turn the key in starting switch to the ON position.
2. When each pilot lamp ① lights on, bulbs are no problem.
3. When each lamp doesn't light, contact your Komatsu distributor for service.

The preheating pilot lamp lights up only when the starting switch is at the HEAT position; the parking brake pilot lamp does not light up when the parking brake is not applied.

When the parking brake is released, the parking brake reminder caution lamp lights up and the alarm buzzer sounds.

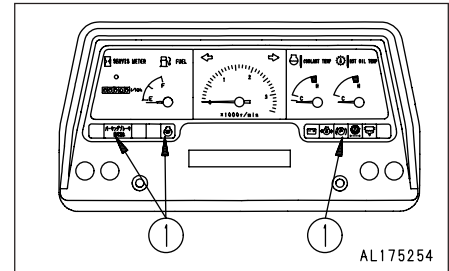

CHECK COOLANT LEVEL, ADD WATER

WARNING

Normally, do not open the radiator cap. Always wait for the engine to cool down before checking the water level, and check using the sub-tank.

1. Open the engine side cover at the rear left side of the machine, and check that the coolant level is between the FULL and LOW marks on sub-tank ①. If the coolant level is low, add water to the FULL level through the water filler in sub-tank ①.
2. After adding water, tighten the cap securely.
3. If sub-tank ① is empty, check for water leakage, then add water to the radiator and sub-tank.

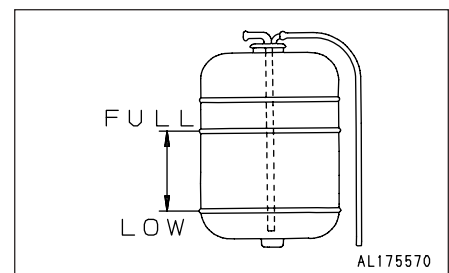
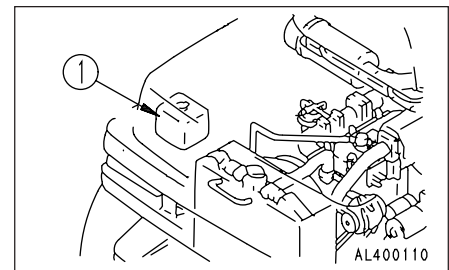

CHECK FUEL LEVEL, ADD FUEL**⚠ WARNING**

When adding fuel, never let the fuel overflow. This may cause a fire. If you spill fuel, thoroughly clean up any spillage.

1. Turn the engine starting switch to the ON position, then check the fuel level with fuel gauge **G**.
After checking, return the starting switch to the OFF position.

2. Upon completion of work, add fuel through filler **F** until the fuel tank is full.

For details of the method for opening and closing the cap, see "11.4 CAP WITH LOCK".

For details of the fuel to use, see "20. USE OF FUEL, COOLANT AND LUBRICANTS ACCORDING TO AMBIENT TEMPERATURE".

3. After adding fuel, tighten the cap securely.

Fuel capacity: WA20	25 ℓ (6.6 US gal, 5.5 UK gal)
WA30, 40, 50	42 ℓ (11.9 US gal, 9.2 UK gal)

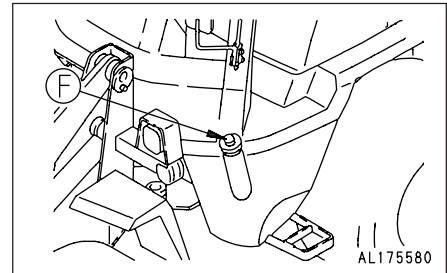
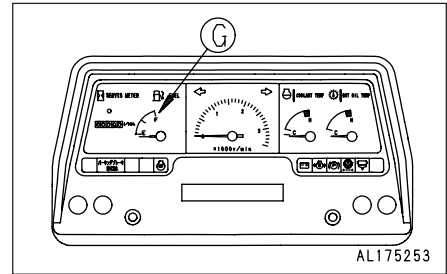

CHECK OIL LEVEL IN ENGINE OIL PAN, ADD OIL

1. Open the tilt hood at the rear of the machine.
2. Remove dipstick **G** and wipe the oil off with a cloth.
3. Insert dipstick **G** fully in the oil filler pipe, then take it out again.
4. The oil level should be between the H and L marks on dipstick **G**.
If the oil level is below the L mark, add engine oil through oil filler **F**.

For details of the oil to use, see "20. USE OF FUEL, COOLANT AND LUBRICANTS ACCORDING TO AMBIENT TEMPERATURE".

5. If the oil is above the H mark, drain the excess engine oil from drain plug **P**, and check the oil level again.
6. If the oil level is correct, tighten the oil filler cap securely, then tighten the tilt hood.

REMARK

When checking the oil level after the engine has been operated, wait for at least 15 minutes after stopping the engine before checking.

If the machine is at an angle, make it horizontal before checking.

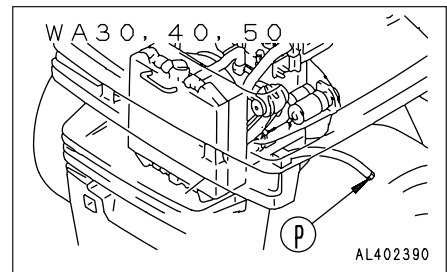
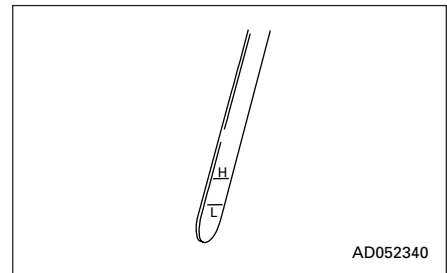
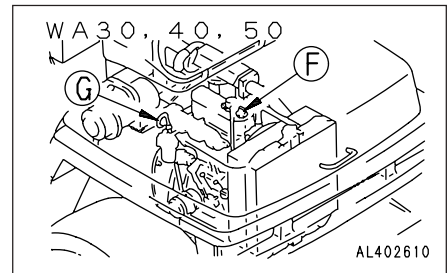
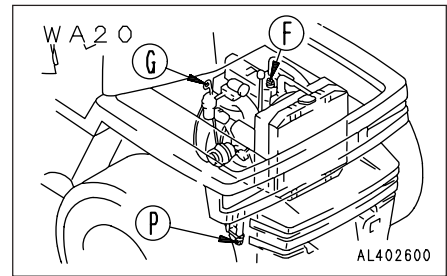

CHECK PARKING BRAKE ALARM BUZZER

Check that the alarm buzzer sounds when the engine is stopped with the parking brake not applied.

CHECK EFFECT OF PARKING BRAKE AND PEDAL STROKE

Depress the parking brake pedal and check that the parking brake pilot lamp lights up after 1 – 2 notches and that the parking brake pedal moves 4 – 7 notches when depressed fully.

If the above value is not correct, or if the braking effect is poor, see "24.2 WHEN REQUIRED".

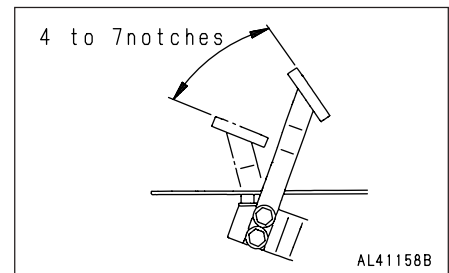
**CHECK TRAVEL OF PARKING BRAKE RELEASE LEVER**

Depress the parking brake pedal 3 – 4 notches, then pull the release lever and check that the parking brake pedal returns to its original position.

The travel of the lever after the brake is released should be 35 – 50 mm (1.4 – 2 in).

If the above value is not correct, see "24.2 WHEN REQUIRED".

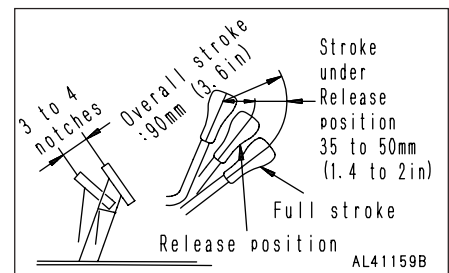
**CHECK EFFECT OF BRAKE AND PEDAL STROKE**

The travel at the tip of the pedal should be 60 – 85 mm (2.4 – 3.4 in).

If the travel is not within the standard range, or the braking effect is poor, see "24.2 WHEN REQUIRED".

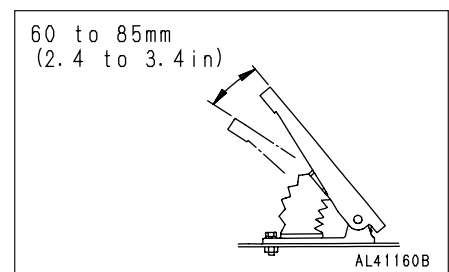
**CHECK STEERING WHEEL PLAY AND OPERATION OF STEERING**

The play at the outside circumference of the steering wheel should be 20 – 40 mm (0.8 – 1.6 in).

If it is more than 40 mm (1.6 in) or the operation of the steering is not smooth, please contact your Komatsu distributor for inspection.

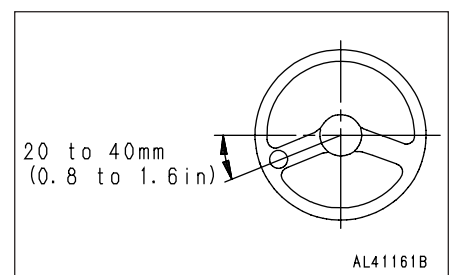

CHECK ELECTRIC WIRING** WARNING**

- **If fuses are frequently blown or if there are traces of short circuit on the electrical wiring, locate the cause and carry out repair.**
- **Accumulation of flammable material (dead leaves, twigs, grass, etc.) around the battery may cause fire, so always check and remove such material.**
- **Keep the top surface of the battery clean and check the breather hole in the battery cap. If it is clogged with dirt or dust, wash the battery cap to clean the breather hole.**

Check for damage of the fuse and any sign of disconnection or short circuit in the electric wiring. Check also for loose terminals and tighten any loose parts.

Check the following points carefully.

- Battery
- Starting motor
- Alternator

When carrying out walk-around checks or checks before starting, always check if there is any accumulation of flammable material around the battery, and remove such flammable material.

Please contact your Komatsu distributor for investigation and correction of the cause.

CHECK SOUND OF HORN

1. Turn the starting switch ① to ON.
2. Check for sound of horn by pushing the horn switch ②.

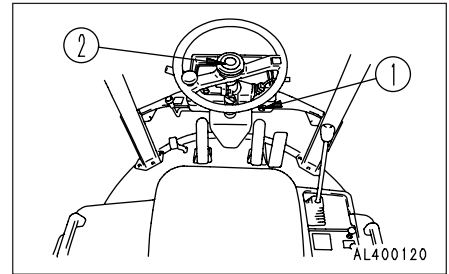
**CHECK FLASHING OF LAMPS, CHECK FOR DIRT OR DAMAGE**
Check for lamps lighting.

1. Turn the starting switch ① to ON.

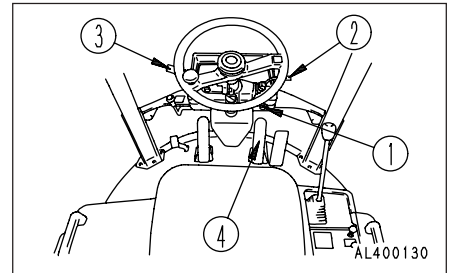

2. Check for the function of lamp switch ② at (A), (B) and (C) positions.

(A): OFF

(B): Tail lamps, panel box, side clearance lamps (option) and number plate lamps (option) light up.

(C): Head lamps light up in addition to lamps lighting up at position (B).

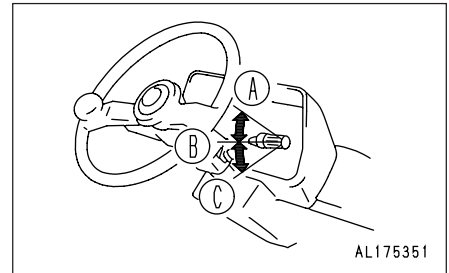

3. Check for lighting of the reverse lamps by positioning the directional lever ③ in REVERSE.

Check for sound of buckup buzzer (option)

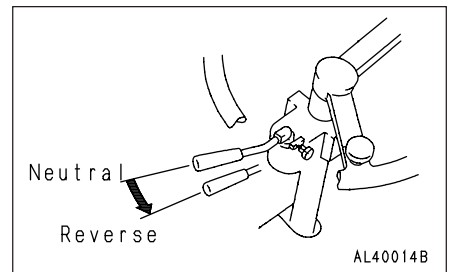

4. Check for lighting of brake lamps by depressing brake pedal ④.

Check for flashing of turn signal lamps.

1. Turn the starting switch ① to ON.
2. Check for function of turn signal lever ② at (A) and (B) positions.
 - (A): Left turn signal lamps (front and rear) flashes.
 - (B): Right turn signal lamps (front and rear) flashes.

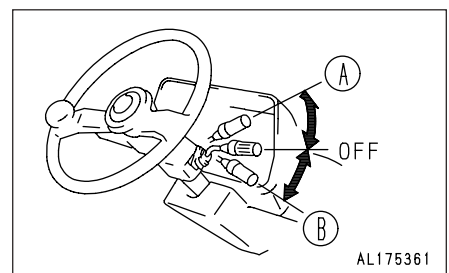

CHECK ENGINE EXHAUST COLOR AND SOUND

CHECK OPERATION OF GAUGES

CHECK DIRECTION OF REAR VIEW MIRROR, CHECK FOR DIRT OR DAMAGE

12.1.3 ADJUSTMENT BEFORE OPERATION OPERATOR'S SEAT

⚠ WARNING

- Park the machine in a safe place and stop the engine when carrying out adjustment of the operator's seat.
- Adjust the seat before starting operations or when changing operators.
- Check that you can depress the brake pedal fully with your back against the seat backrest.

Forward-backward adjustment

Move lever ① to the right, move the seat to the best position and release the lever.

Fore-and-aft adjustment: 140 mm (5.5 in)
8 stages

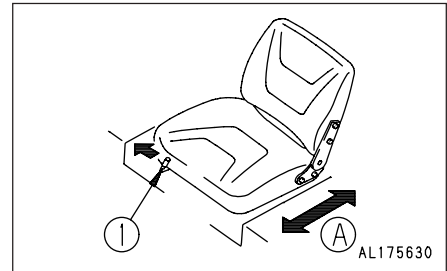

ADJUST REAR VIEW MIRROR

Sit in the operator's seat and adjust the rear view mirror so that you can see properly to the rear.

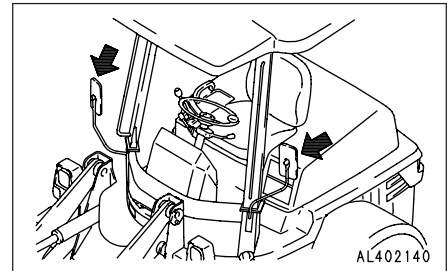

12.1.4 OPERATIONS AND CHECKS BEFORE STARTING ENGINE

WARNING

If the control levers are touched by accident, the work equipment may move suddenly. When leaving the operator's compartment, always set the safety lock securely to the LOCK position.

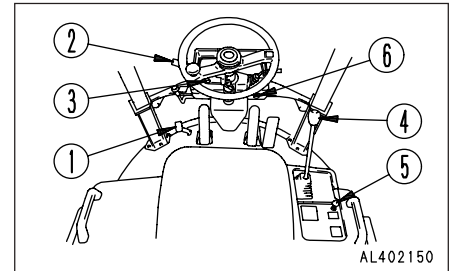

1. Check that parking brake pedal ① is at the LOCK position.

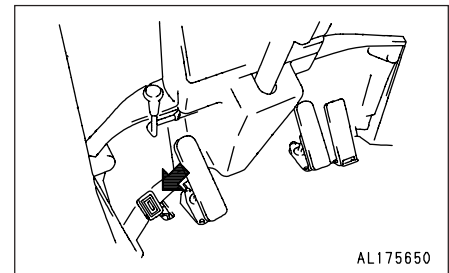

2. Check that directional lever ② is at the N position, and that it is locked by safety lock ③.
When starting the engine, if directional lever ② is not at the N position, the engine will not start.

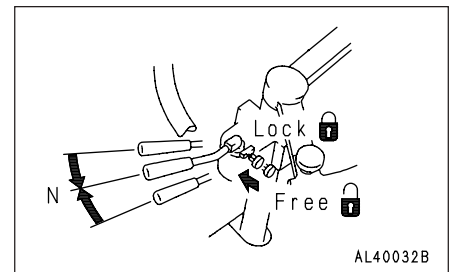

3. Lower the bucket to the ground, then check that work equipment control lever ④ is locked by safety lock ⑤.

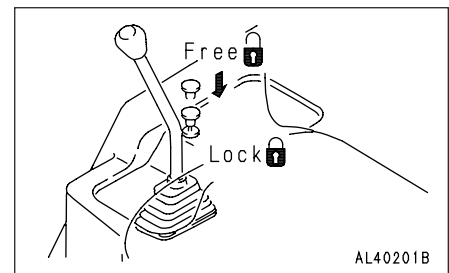

4. Insert the key in starting switch ⑥, turn the key to the ON position, and check that the pilot lamp lights up.

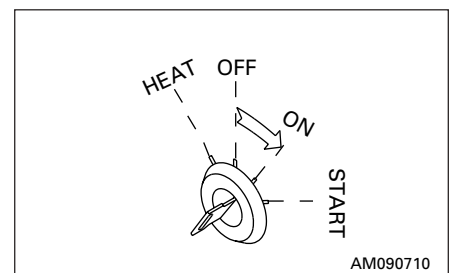

12.2 STARTING ENGINE

12.2.1 NORMAL STARTING

WARNING

Check that there are no persons or obstacles in the surrounding area, then sound the horn and start the engine.

NOTICE

Do not keep the starting motor rotating continuously for more than 20 seconds.

If the engine will not start, wait for at least 2 minutes before trying to start the engine again.

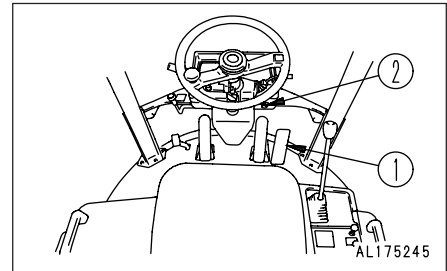

1. Depress accelerator pedal ① lightly.

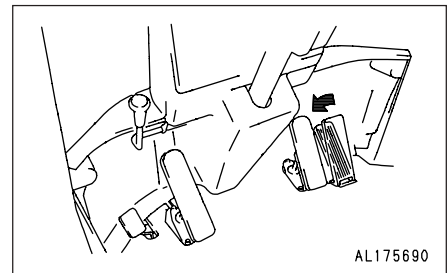

2. Turn the key in starting switch ② to the ON position.

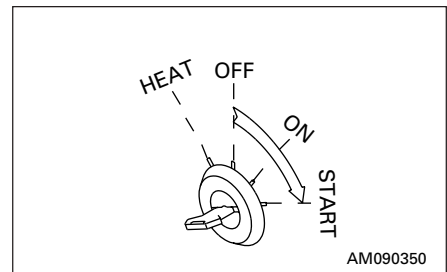

3. When engine is started, release the key of starting switch ② and the key will return automatically to ON.

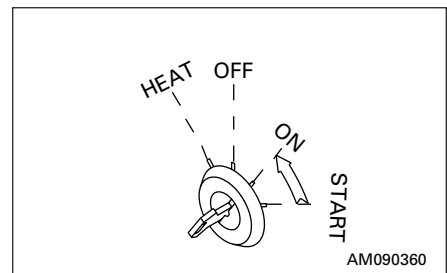

12.2.2 STARTING IN COLD WEATHER

⚠ WARNING

- Check that there are no persons or obstacles in the surrounding area, then sound the horn and start the engine.
- Never use starting aid fluids as they may cause explosions.

NOTICE

Do not keep the starting motor rotating continuously for more than 20 seconds.

If the engine fails to start, repeat from step 2 and after waiting for about 2 minutes.

1. Hold the key in starting switch ① at the HEAT position, and check that preheating pilot lamp ② lights up for 15 seconds.

The table shown below gives a guide to preheating time.

Coolant Temperature	Preheating time
Above 0°C	–
0°C to -10°C	15 seconds
-10°C to -20°C	30 seconds

The preheating time in cold areas changes according to the water temperature when starting the engine.

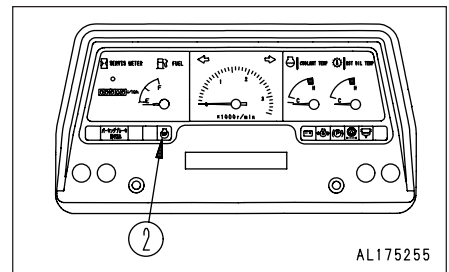
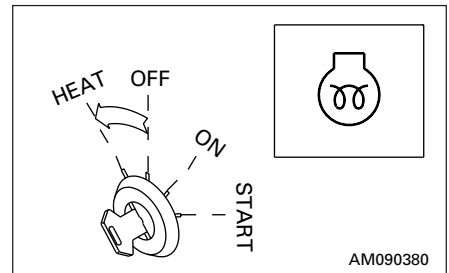
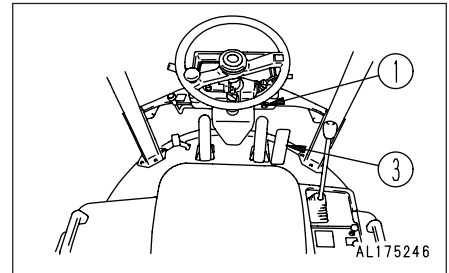

2. Depress accelerator pedal deeply.

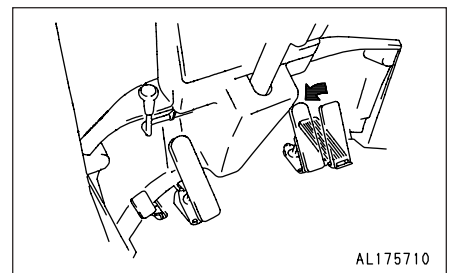

3. When preheating pilot lamp ② flashes, turn the key in starting switch ① to the START position to start the engine.

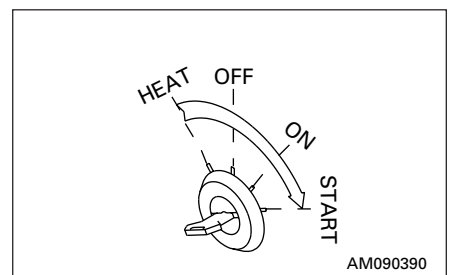

4. When engine starts, release the key of starting switch ①. The key will return automatically to the ON position.
5. When the engine speed rises, depress accelerator pedal ③ lightly and hold it in position.

If the engine does not start, wait for 2 minutes, then repeat Steps 1, 2, and 3.

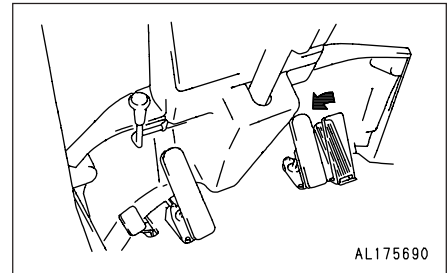
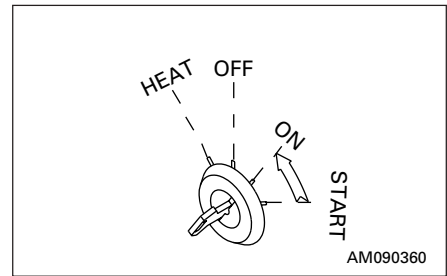

12.3 OPERATIONS AND CHECKS AFTER STARTING ENGINE

⚠ WARNING

- **Emergency stop**
If there has been any abnormal actuation or trouble, turn the starting switch key to the OFF position.
- If the work equipment is operated without warming the machine up sufficiently, the response of the work equipment to the movement of the control lever will be slow, and the work equipment may not move as the operator desires, so always carry out the warming-up operation. Particularly in cold areas, be sure to carry out the warming-up operation fully.

NOTICE

- The most suitable temperature for the hydraulic oil is 50 – 80°C, but in order to extend the life of the machine, the temperature must be raised to at least 20°C before starting work.
- Do not suddenly operate the levers when the hydraulic oil temperature is below 20°C
- Do not suddenly accelerate the engine before the warming-up operation is completed.
Do not run the engine at low idling or high idling continuously for more than 20 minutes.
If it is necessary to run the engine at idling, apply a load from time to time or run the engine at a mid-range speed.

After starting the engine, do not immediately start operations. First, carry out the following operations and checks.

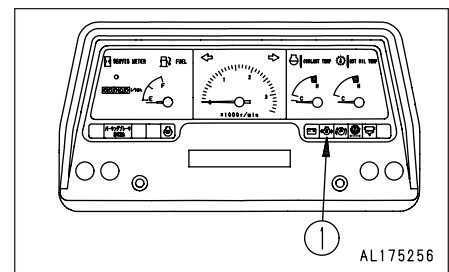

1. Run the engine at low idling and check that engine oil pressure caution lamp ① is out.

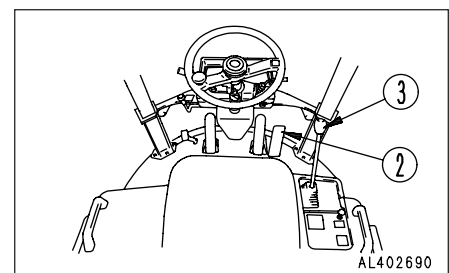

2. Depress accelerator pedal ② lightly and run the engine with no load at midrange speed for about 5 minutes.

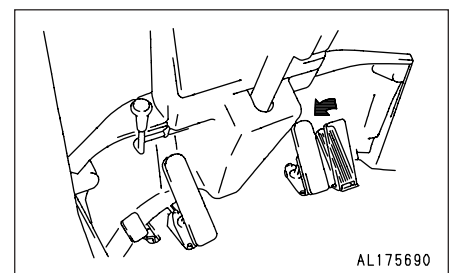

3. Operate work equipment control lever ③ slowly to move the bucket cylinder and lift cylinder to the end of their stroke.
4. Operate the bucket and lift arm for 30 seconds each in turn.

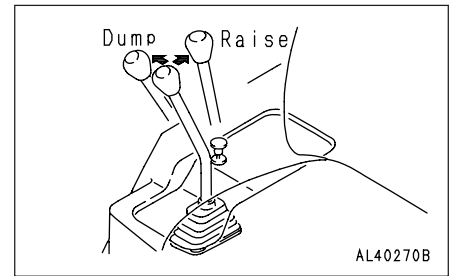

5. After carrying out the warming-up operation, check that the gauges and pilot lamps are normal.
If any abnormality is found, carry out repairs.
Operate the machine under light load until engine water temperature gauge ④ and HST oil temperature gauge ⑤ are in the white range.

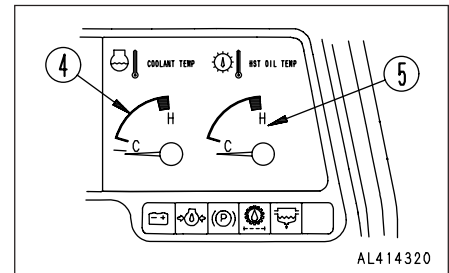

6. Check that there is no abnormal exhaust gas color, noise, or vibration.
If any abnormality is found, carry out repairs.

12.4 MOVING MACHINE OFF

WARNING

When moving the machine off, check that the area around the machine is safe, then sound the horn before starting. Do not allow people near the machine. There is a blind spot behind the machine, so be particularly careful when traveling in reverse.

1. Check that caution pilot lamp ① is not lighted up.

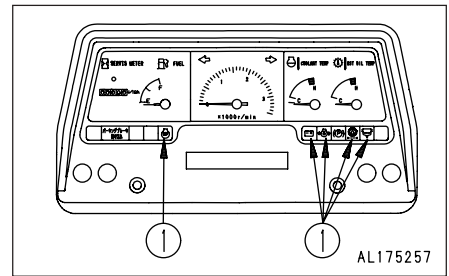

2. Set safety lock ③ of work equipment control lever ② to the FREE position.

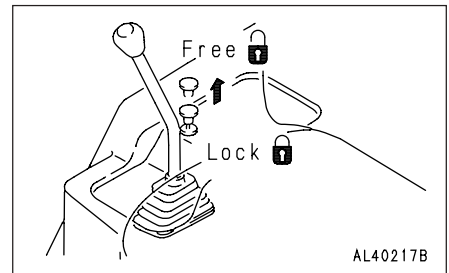
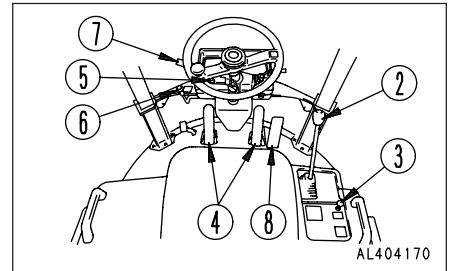

3. Operate work equipment control lever ② to raise the bucket 25 – 45 cm (10 – 18 in) from the ground, then tilt the bucket back.

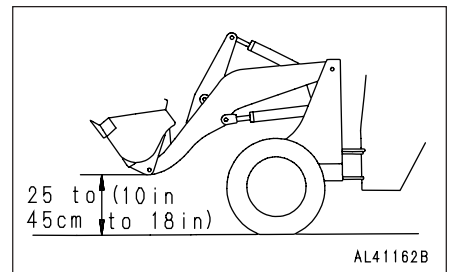

4. Depress brake pedal ④, then pull parking brake release lever ⑤ back to release the parking brake. If the parking brake is still locked, the machine will not move even if the directional lever is operated. (It is equipped with a mechanism to prevent the parking brake from dragging.)

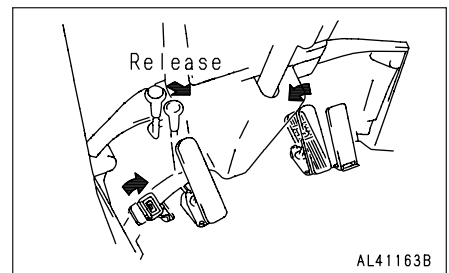

5. Set safety lock ⑥ of directional lever ⑦ to the FREE position, then set directional lever ⑦ to the desired position.

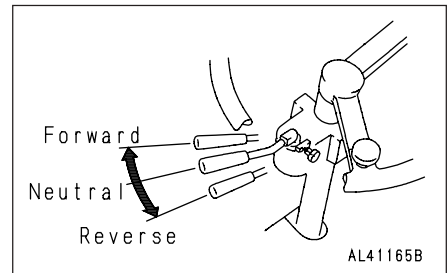
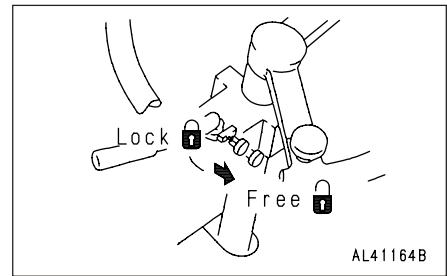

6. Release brake pedal ④, then depress accelerator pedal ⑧ to move the machine off.

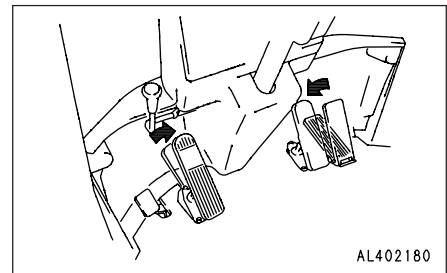
**REMARK**

When starting on a slope, depress the left brake pedal, then depress the accelerator pedal and slowly release the brake pedal to allow the machine to start.

12.5 CHANGING DIRECTION

⚠ WARNING

- When changing direction between FORWARD and REVERSE, check that the new direction of travel is safe. There is a blind spot behind the machine, so be particularly careful when changing direction to travel in reverse.
- When traveling at high speed, do not switch between FORWARD and REVERSE or from FORWARD or REVERSE to neutral, or apply the brake suddenly except in emergencies.

To ensure safety and relieve the shock, reduce speed before switching between FORWARD and REVERSE.

Place directional lever ① in the desired position.

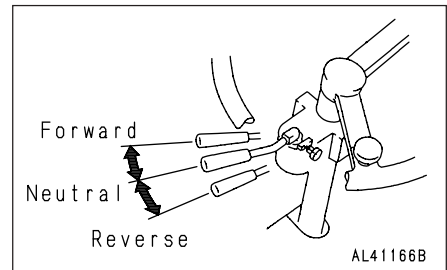
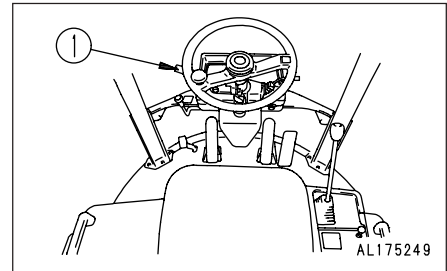

12.6 TURNING

⚠ WARNING

- It is dangerous to turn the machine suddenly at high speed, or to turn on steep hills.
- If the engine stops when the machine is traveling, the steering wheel becomes heavy, so do not stop the engine. This is particularly dangerous on hills, so never stop the engine when the machine is traveling. If the engine stops, stop the machine immediately at a safe place.

When traveling, use steering wheel ① to turn the machine.

With this machine, the front frame is joined to the rear frame at the center of the machine by the center pin. The front and rear frames bend at this point, and the rear wheels follow in the same track as the front wheels when turning.

Turn the steering wheel lightly to follow the machine as it turns. When turning the steering wheel fully, do not turn it beyond the end of the stroke.

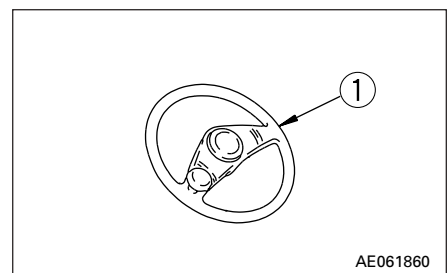

12.7 STOPPING MACHINE

⚠ WARNING

- Avoid stopping suddenly. Give yourself ample room when stopping.
- Do not park the machine on slopes.
If the machine has to be parked on a slope, set it facing directly down the slope, then dig the bucket into the ground and put blocks under the tires to prevent the machine from moving.
- If the control lever is touched by accident, the work equipment or the machine may move suddenly, and this may lead to a serious accident. Before leaving the operator's compartment, always set the safety lock lever securely to the LOCK position.

NOTICE

Never use the parking brake pedal to brake the machine when traveling except in an emergency. Apply the parking brake only after the machine has stopped.

1. Release accelerator pedal ①, and depress brake pedals ② to stop the machine. The left and right brake pedals are interconnected, so the machine can be stopped by pressing either of the brake pedals.
2. Place directional lever ③ in N (neutral) and safety lock to the LOCK position.
3. Depress parking brake pedal ④ to LOCK to apply the parking brake.
Check that the parking brake pilot lamp has lighted up.
4. Release brake pedal ②.

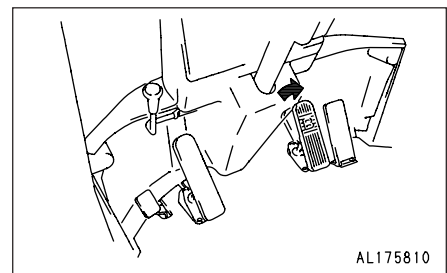
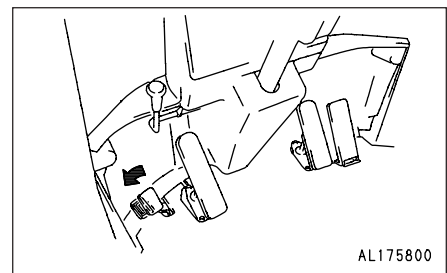
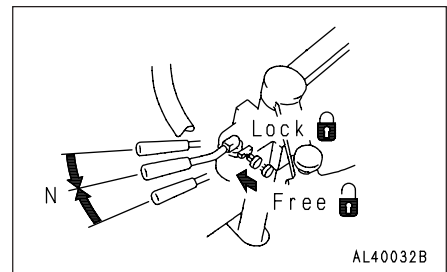
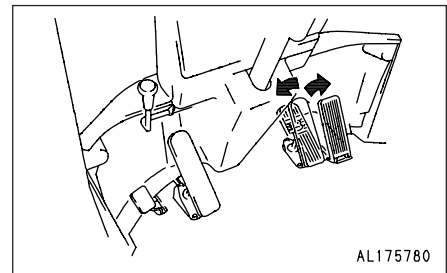
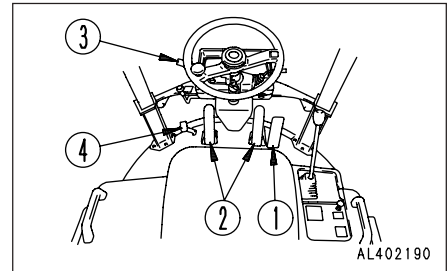
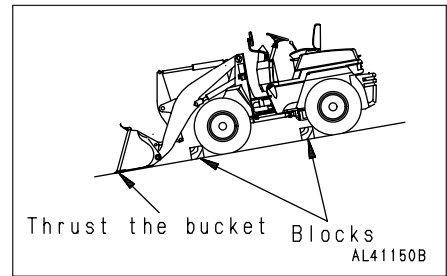



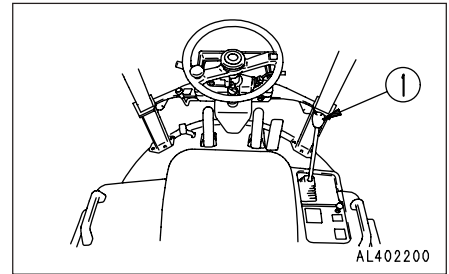

12.8 OPERATION OF WORK EQUIPMENT

Work equipment control lever ① can be used to operate the lift arm and bucket as follows.



LIFT ARM OPERATION

- ① Raise ()
- ② Hold (): The lift arm is kept in the same position.
- ③ Lower ()
- ④ Float (): The lift arm moves freely under external force.

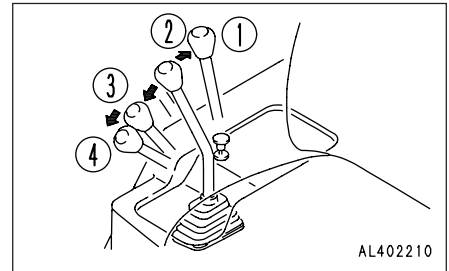

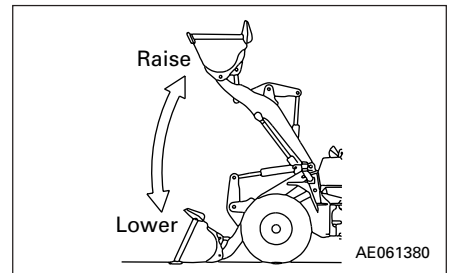

NOTICE

Do not use the FLOAT position when lowering the bucket.



BUCKET OPERATION

- A Tilt ()
- B Dump ()

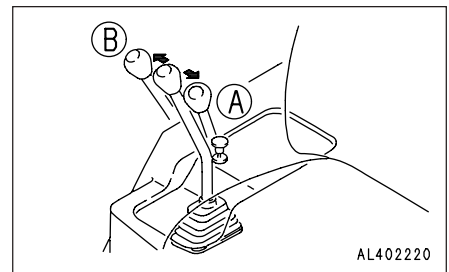

When the bucket has been operated to the DUMP position, if the control lever is pulled to the TILT position, it will be held at that position and the bucket will continue to move.

When the bucket reaches the position set by the bucket positioner, the control lever is automatically returned to the HOLD position and the bucket movement stops.

If the lift arm is lowered in this condition, the bucket will contact the ground horizontally. If the bucket is not horizontal, adjust again. For details, see "12.11 ADJUSTING WORK EQUIPMENT POSTURE".

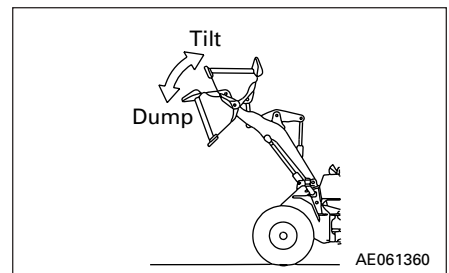

12.9 WORK POSSIBLE USING WHEEL LOADER

In addition to the following, it is possible to further increase the range of applications by using various attachments.

12.9.1 DIGGING OPERATIONS

WARNING

Always set the machine facing directly to the front when carrying out digging or scooping operations. Never carry out these operations with the machine articulated.

NOTICE

If the tires slip, the tire life will be reduced, so do not allow the tires to slip during operation.

- Scoop up the piled soil by moving the machine forward as shown below. If the tires begin slipping under heavy load, raise the bucket slightly to reduce the load.

1. Force the bucket into the pile of soil while moving the machine forward.

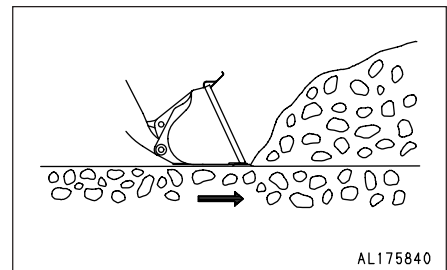

2. After the bucket has fully penetrated into the soil, place the work equipment control lever in raise position while moving the machine forward. Move the work equipment control lever to tilt position from time to time until the bucket is filled with soil.

Try to keep the load in the center of the bucket; if the load is on one side of the bucket, the load will be unbalanced.

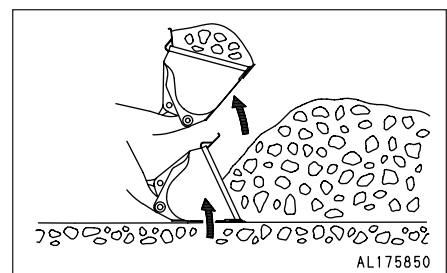

3. When it is difficult for the bucket to penetrate into the piled soil, move the work equipment control lever left and right to move the bucket teeth up and down.

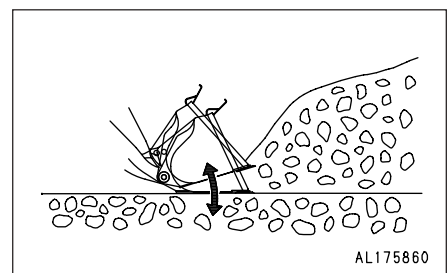

- When digging and loading on level ground, set the bucket edge facing down slightly as follows and drive the machine forward. Always be careful not to load the bucket on one side and cause an unbalanced load.

A suitable depth for each digging pass is 5 – 10 cm (2 – 4 in).

1. Set the edge of the bucket facing slightly down.

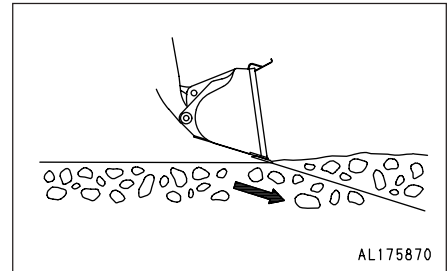

2. Drive the machine forward and operate the work equipment control lever forward to cut a thin layer of the surface each time when excavating the soil.

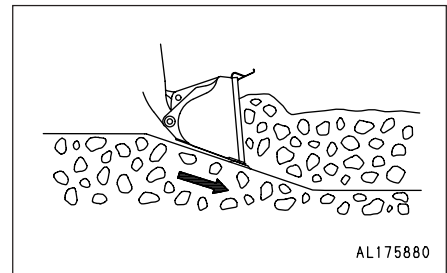

3. Operate the work equipment control lever slightly up and down to reduce the resistance when driving the machine forward.

When digging with the bucket, avoid imposing the digging force onto only one side of the bucket.

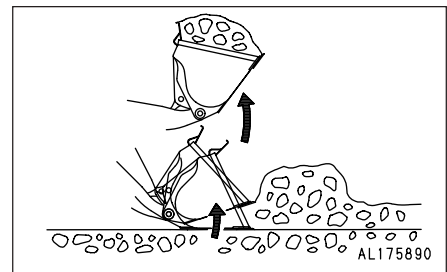

12.9.2 LEVELING OPERATIONS

NOTICE

Always operate the machine in reverse when carrying out leveling operations.

If it is necessary to carry out leveling operations when traveling forward, do not set the bucket dumping angle to more than 20°.

1. Scoop soil into the bucket. Move the machine backward while spreading soil from the bucket little by little.
2. Go over the spread soil with the bucket teeth touching the ground and level the ground by back-dragging.
3. Scoop some more soil into the bucket, put the lift arm in float, level the bucket at ground level, and smooth the ground by moving backward.

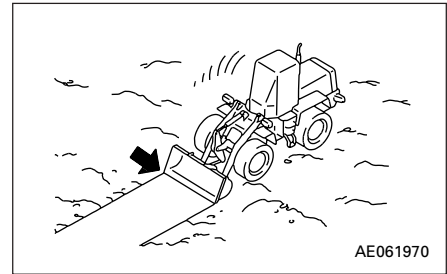

12.9.3 PUSHING OPERATIONS

NOTICE

Never set the bucket to the DUMP position when carrying out pushing operation.

1. When carrying out pushing operations, set the bottom of the bucket parallel to the ground surface.

12.9.4 LOAD AND CARRY OPERATIONS

WARNING

When carrying a load, lower the bucket to lower the center of gravity when traveling.

The load and carry method for wheel loaders consists of a cycle of scooping → hauling → loading (into a hopper, glory hole, etc.)

Always keep the travel path properly maintained.

When using the load and carry method, see "12.17 HANDLING TIRES".

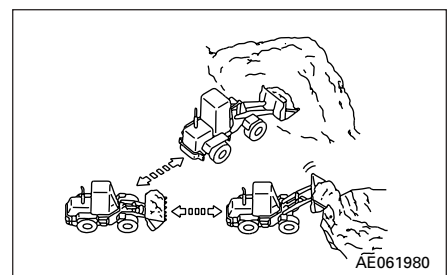

12.9.5 LOADING OPERATIONS

Select the method of operation which will give the minimum amount of turning and travel in order to provide the most efficient method for the jobsite.

WARNING

- Always keep the working area flat. Do not turn suddenly or apply the brake suddenly when traveling with a raised load. These actions are dangerous.
- It is also dangerous to drive the bucket at high speed into a stockpile or pile of rocks.

NOTICE

- If the tires slip, the tire life will be reduced, so do not allow the tires to slip during operation.
- Avoid excessive shaking of the bucket.

CROSS DRIVE LOADING

Always set the wheel loader facing at a right angle to the stockpile. After digging in and scooping up the load, drive the machine straight back in reverse, then bring the dump truck in between the stock pile and the wheel loader.

This method requires the least time for loading, and is extremely effective in reducing the cycle time.

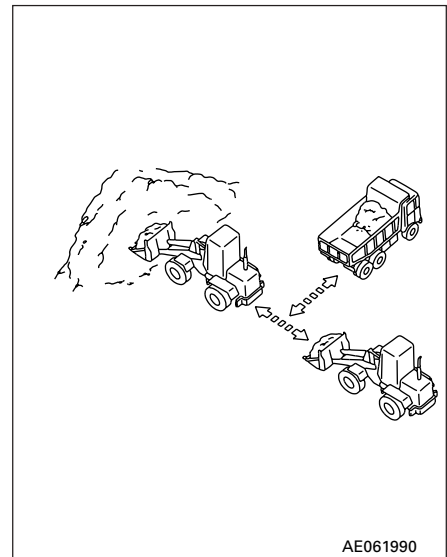

V-SHAPE LOADING

Position the dump truck so that the direction of approach of the wheel loader is approx. 60° from the direction of approach to the stockpile. After loading the bucket, drive the wheel loader in reverse, then turn it to face the dump truck and travel forward to load the dump truck.

The smaller the turning angle of the wheel loader is, the more efficient the operation becomes.

When loading a full bucket and raising it to the maximum height, first shake the bucket to stabilize the load before raising the bucket. This will prevent the load from spilling to the rear.

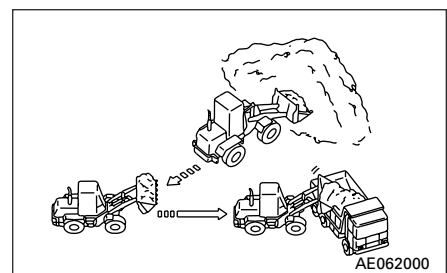

Precautions when piling up loads

When forming products into a pile, be careful not to let the rear counterweight come into contact with the ground.

Do not set the bucket to the DUMP position when carrying out piling-up operations.

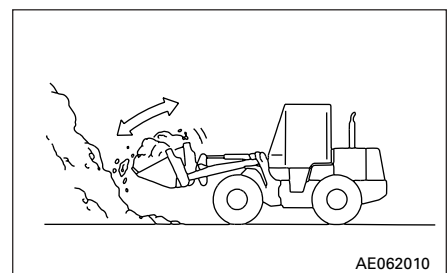

12.10 PRECAUTIONS FOR OPERATION

12.10.1 PERMISSIBLE WATER DEPTH

When working in water or on swampy ground, do not let the water come above the bottom of the axle housing.

After finishing the operation, wash and check the lubricating points.

12.10.2 IF WHEEL BRAKE DOES NOT WORK

If the machine is not stopped by depressing the brake pedal, use the parking brake to stop the machine.

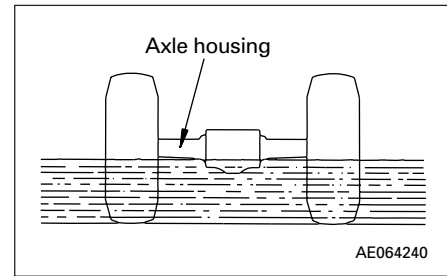

NOTICE

If the parking brake has been used as an emergency brake, contact your Komatsu distributor to have the parking brake checked for any abnormality.

12.10.3 PRECAUTIONS WHEN DRIVING UP OR DOWN SLOPES

LOWER THE CENTER OF GRAVITY WHEN TURNING.

When turning on slopes, lower the work equipment to lower the center of gravity before turning. It is dangerous to turn the machine with the work equipment raised.

BRAKING ON DOWNHILL SLOPES

If the foot brake is used too frequently when traveling downhill, the brake may overheat and be damaged. To avoid this problem, operate the accelerator pedal and make full use of the braking force of the engine.

IF ENGINE STOPS

If the engine stops on a slope, depress the brake pedal immediately, lower the work equipment to the ground, then depress the parking brake pedal fully to hold the machine. Return the directional lever to the N position and start the engine again.

When the engine stops with the parking brake released, the alarm buzzer will sound; when the parking brake is applied, the buzzer will stop.

If the machine must be stopped on a slope, depress the parking brake pedal fully and put blocks under the tires. Lower the bucket to the ground and dig the teeth in for increased safety.

Even when the parking brake is not applied, the machine will appear to be stopped. However, the oil may leak out gradually and allow the machine to start moving, so always be sure to apply the parking brake securely.

12.10.4 PRECAUTIONS WHEN DRIVING MACHINE

When the machine travels at high speed for a long distance, the tires become extremely hot. This causes early wear of the tires, so it should be avoided as far as possible. If the machine must be driven for a long distance, take the following precautions.

- Follow the regulations related to this machine, and drive carefully.
- Before driving the machine, carry out the checks before starting.
- The most suitable tire pressure, travel speed, or tire type differ according to the condition of the travel surface. Contact your Komatsu distributor or tire dealer for information.
- The following is a guide to suitable tire pressures and speeds when traveling on a paved surface with standard tires.

	WA20	WA30	WA40, 50
Air pressure MPa (kgf/cm ²)	All wheels 0.18 (1.8)	All wheels 0.2 (2.0)	All wheels 0.18 (1.8)

- Check the tire pressure before starting, when the tire is cool.
- After traveling for 1 hour, stop for 30 minutes. Check the tires and other parts for damage; also check the oil and coolant levels.
- Always travel with the bucket empty.

12.11 ADJUSTING WORK EQUIPMENT POSTURE

⚠ WARNING

- Stop the machine on flat ground and put blocks in front and behind the wheels.
- Apply the parking brake.
- Secure the front and rear frames with the safety bar.
- Do not go under the work equipment when the arm is raised.

The boom kickout makes it possible to set the bucket so that it automatically stops at the desired lifting height (lift arm higher than horizontal) and the bucket positioner makes it possible to set the bucket so that it automatically stops at the desired digging angle. The setting can be adjusted to match the working conditions.

12.11.1 ADJUSTING BUCKET POSITIONER (WA30, 40, 50)

1. Lower the bucket to the ground and adjust the bucket to the desired digging angle. Set the work equipment control lever at HOLD, stop the engine and adjust as follows.
2. Loosen two bolts ① and adjust mounting bracket ④ of the proximity switch so that the rear tip of bar ② is in line with the center of the sensing surface of proximity switch ③. Then tighten the bolts to hold the bracket in position.
3. Loosen 2 nuts ⑤ and adjust so that the clearance between the sensing surface of proximity switch ③ and bar ② is within a range of 3 – 5 mm (0.12 – 0.20 in), then secure in position.
4. Adjust the proximity switch so that dimension a at the end of proximity switch mounting bracket ④ and the sensing surface of proximity switch ③ is at least 1 mm (0.04 in), then secure in position.

Tightening torque: $17.2 \pm 2.5 \text{ N}\cdot\text{m}$ ($1.75 \pm 0.25 \text{ kgf}\cdot\text{m}$, $12.7 \pm 1.8 \text{ lbft}$)

5. After adjusting, start the engine and raise the lift arm. Operate the work equipment control lever to the DUMP position, then operate it to the TILT position and check that the work equipment control lever is automatically returned to HOLD when the bucket reaches the desired angle.

12.11.2 BUCKET LEVEL INDICATOR

Ⓐ and Ⓑ at the top rear of the bucket are the level indicators, so the bucket angle can be checked during operations.

- Ⓐ: Parallel with cutting edge
- Ⓑ: 90° to cutting edge

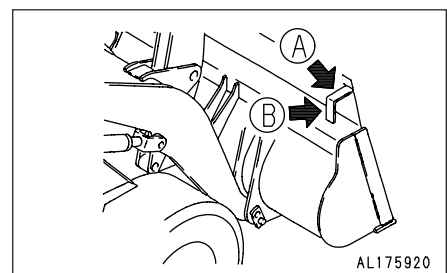
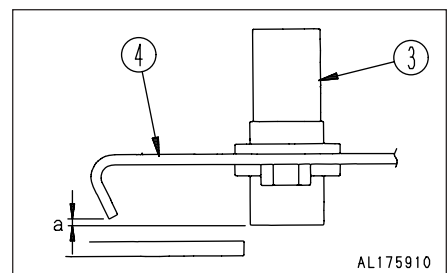
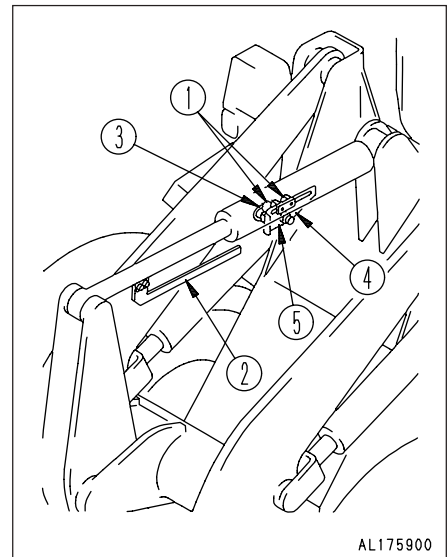

12.12 PARKING MACHINE

⚠ WARNING

- Avoid stopping suddenly. Give yourself ample room when stopping.
- Do not park the machine on slopes.
If the machine has to be parked on a slope, set it facing directly down the slope, then dig the bucket into the ground and put blocks under the tires to prevent the machine from moving.
- If the control lever is touched by accident, the work equipment or the machine may move suddenly, and this may lead to a serious accident. Before leaving the operator's compartment, always set the safety lock lever securely to the LOCK position.

NOTICE

Never use the parking brake lever to brake the machine when traveling except in an emergency. Apply the parking brake only after the machine has stopped.

1. Release accelerator pedal ①, and depress brake pedals ② to stop the machine. The left and right brake pedals are interconnected, so the machine can be stopped by pressing either of the brake pedals.

2. Place directional lever ③ in N (neutral).

3. Depress parking brake pedal ④ to LOCK to apply the parking brake. Check that the parking brake pilot lamp has lighted up.

4. Lock directional lever ③ with safety lock ⑤.

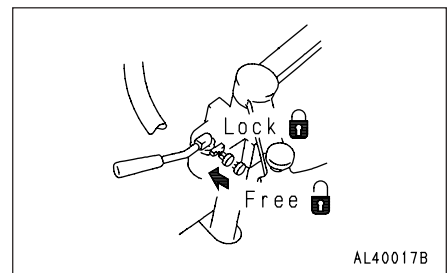
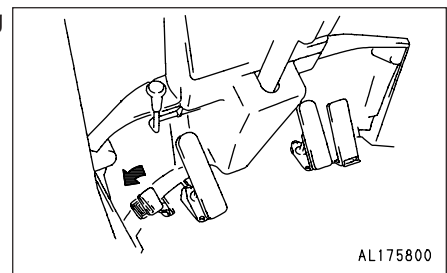
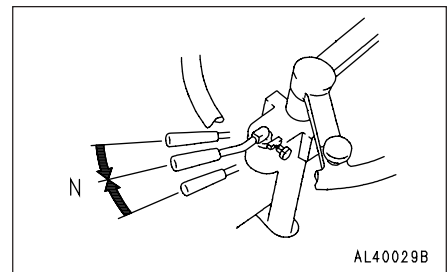
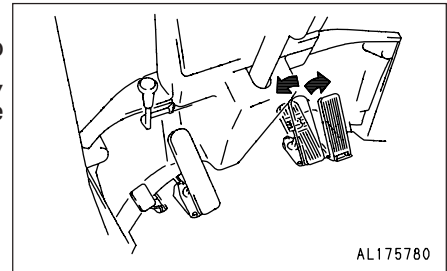
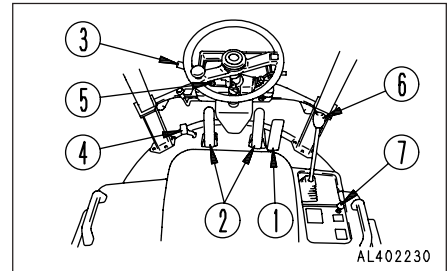
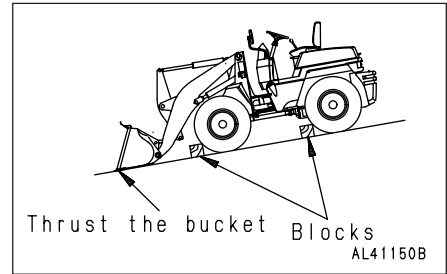

5. Release brake pedal ②.

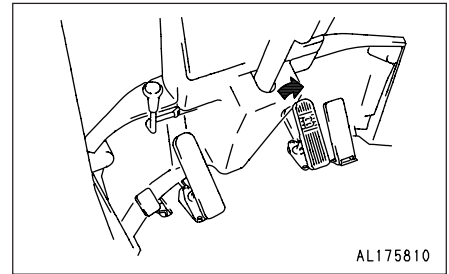

6. Operate work equipment control lever ⑥ to lower the bucket to the ground.

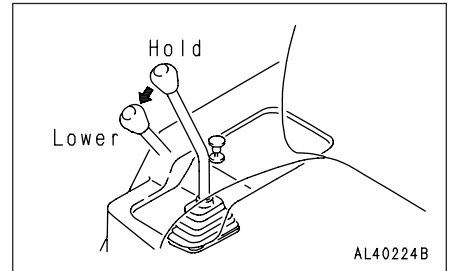

7. Lock work equipment control lever ⑥ with safety lock ⑦.

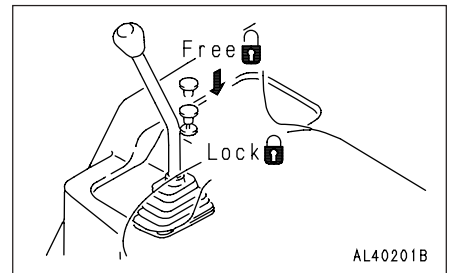

12.13 CHECKS AFTER COMPLETION OF OPERATION

Check the engine water temperature, engine oil pressure, HST oil temperature, and fuel level with the meter and lamps.

If the engine has overheated, do not stop it suddenly. Run the engine at a midrange speed to allow the engine to cool down before stopping it.

12.14 STOPPING ENGINE

NOTICE

If the engine is abruptly stopped before it has cooled down, engine life may be greatly shortened. Consequently, do not abruptly stop the engine apart from an emergency.

In particular, if the engine has overheated, do not abruptly stop it but run it at medium speed to allow it to cool gradually, then stop it.

1. Run the engine at low idling speed for about 5 minutes to allow it to gradually cool down.

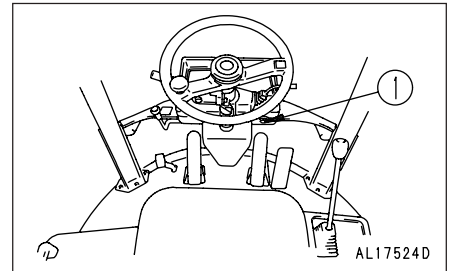

2. Turn the key in starting switch ① to the OFF position and stop the engine.
3. Remove the key from starting switch ①.

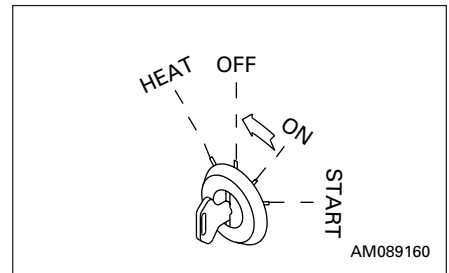

12.15 CHECK AFTER STOPPING ENGINE

1. Walk around the machine and check the work equipment, body work, and undercarriage, and check also for leakage of oil and water. If any leakage or abnormality is found, carry out repairs.
2. Fill the fuel tank.
3. Remove any waste paper or dead leaves from inside the engine room. These may cause a fire.
4. Remove any mud stuck to the undercarriage.

12.16 LOCKING

Always lock the following places.

- ① Fuel tank filler cap

REMARK

The starting switch key is used also for lock ①.

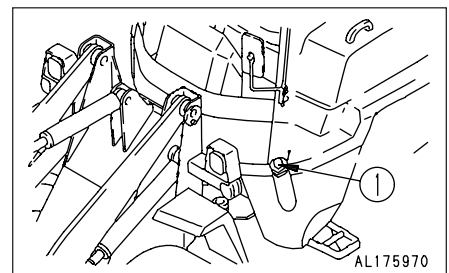

12.17 HANDLING THE TIRES

12.17.1 PRECAUTIONS WHEN HANDLING TIRES

CAUTION

If a tire has reached any of the following service limits, there is danger that the tire may burst or cause an accident, so to ensure safety, replace it with a new tire.

- **Service limits for wear**
 - When the remaining depth of the groove on construction equipment tires (at a point approx. 1/4 of the tread width) is 15% of the groove depth on a new tire.
 - When the tire shows marked uneven wear, stepped wear or other abnormal wear, or when the cord layer is exposed.
- **Service limits for damage**
 - When there is external damage extending to the cord or when the cord is broken
 - When the cord is cut or there is dragging
 - When the tire is peeling (there is separation)
 - When the bead is damaged
 - For tubeless tires, when there is air leakage or improper repair

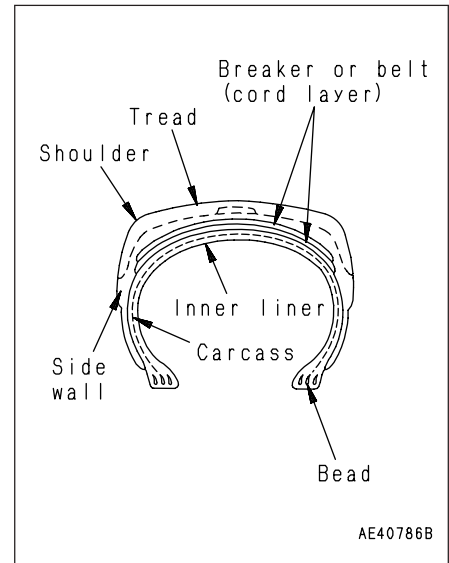

Please contact your Komatsu distributor when replacing the tires. It is dangerous to jack up the machine without taking due care.

12.17.2 TIRE PRESSURE

Measure the tire pressure before starting operations, when the tires are cool.

If the tire inflation pressure is too low, there will be overload; if it is too high, it will cause tire cuts and shock burst. To prevent these problems, adjust the tire inflation pressure according to the table below.

	WA20	WA30	WA40, 50
Air pressure MPa (kgf/cm ²)	0.18 (1.8)	0.2 (2.0)	0.18 (1.8)

If the deflection of the tire is excessive, raise the inflation pressure within the limits given in the table below to give a suitable deflection.

	WA20	WA30	WA40, 50
Air pressure MPa (kgf/cm ²)	0.20 – 0.22 (2.0 – 2.2)	0.22 – 0.24 (2.2 – 2.4)	0.20 – 0.22 (2.0 – 2.2)

$$\text{Deflection ratio} = \frac{H - h}{H} \times 100$$

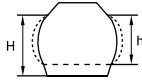

As a guideline that can be checked visibly, the deflection ratio of the front tire (deflection/free height) is as follows.

When carrying normal load (lift arm horizontal): Approx. 15 – 25%

When digging (rear wheels off ground): Approx. 25 – 35%

When checking the tire inflation pressure, check also for small scratches or peeling of the tire, for nails or pieces of metal which may cause punctures, and for any abnormal wear.

Clearing fallen stones and rocks from the operating area and maintaining the surface will extend the tire life and give improved economy.

12.17.3 REPLACING TIRES

REMOVING TIRES

1. Lower the work equipment to the ground and apply the parking brake.
2. Loosen all wheel hub bolts ① one turn.
3. Jack up the machine.
4. Remove wheel hub bolts ①, then replace the tire.

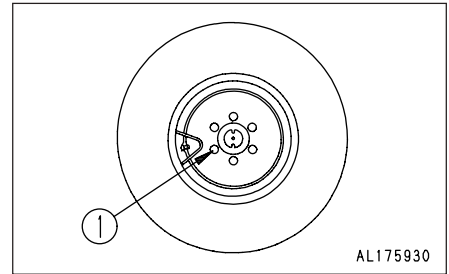

INSTALLING TIRE

1. Coat the wheel hub bolts and tap holes with oil.
2. With the tire jacked up off the ground, tighten the wheel hub bolts lightly in the order shown in the diagram on the right.
3. After tightening the wheel hub bolts partially, lower the machine to the ground, then tighten to the specified torque.

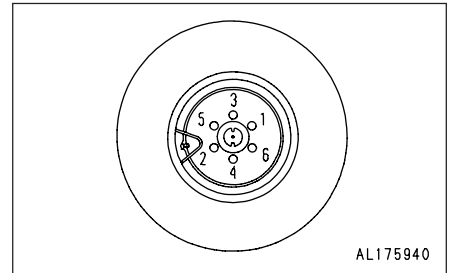

	WA20	WA30, 40, 50
Tightening torque N•m (kgf•m)	168 ± 15 (17 ± 1.5)	441 ± 49 (45 ± 5)

DIRECTION FOR INSTALLING TIRE

The tire tread has a lug shape (to provide strong rimpull and flotation even on soft ground), so be careful to install with the tread pattern facing in the correct direction.

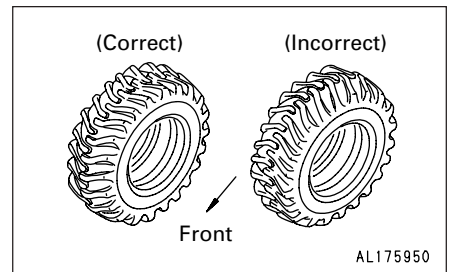

13. TRANSPORTATION

When transporting the machine, observe all related laws and regulations, and be careful to assure safety.

13.1 LOADING, UNLOADING WORK

⚠ WARNING

- **Make sure the ramp has sufficient width, length and thickness to enable the machine to be safely loaded and unloaded.**
- **When loading and unloading the machine, park the trailer on a flat firm roadbed. Keep a fairly long distance between the road shoulder and the machine.**
- **Remove the mud from the undercarriage to prevent the machine from slipping to the side on slopes. Be sure the ramp surface is clean and free of grease, oil, ice and loose materials.**
- **Never change the direction of travel when on the ramps. If it is necessary to change direction, drive off the ramps and correct the direction, then drive on to the ramps again.**

When loading or unloading, always use ramps or a platform and carry out the operations as follows.

1. Properly apply the brakes on the trailer and insert blocks beneath the tires to ensure that it does not move. Then fix the ramps in line with the centers of the trailer and the machine. Be sure that the two sides are at the same level as one another. If the ramp sags appreciably, reinforce it with blocks, etc.
2. Determine the direction of the ramp, then slowly load or unload the machine.
3. Correctly load the machine onto the specified part of the trailer.

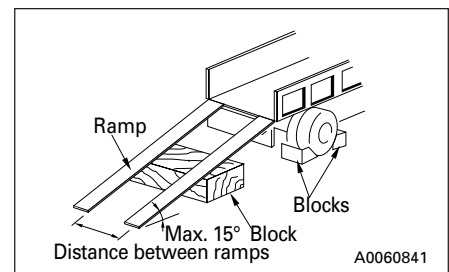

13.2 PRECAUTIONS FOR LOADING

After loading the machine in the specified position, secure it in place as follows.

1. Lower the work equipment slowly.
2. Apply the safety lock to lock all the control levers securely.
3. Turn the starting switch to the OFF position and stop the engine. Remove the key from the starting switch.
4. Lock front frame and rear frame with safety bar.
5. Put blocks in front and behind the wheels, and secure the machine with chains or wire rope to prevent the machine from moving during transportation.

13.3 LIFTING MACHINE

⚠ DANGER

- When lifting the machine, check that the wire rope is fitted correctly. If it is not fitted correctly, there is danger that the machine may fall and cause serious injury or death. Raise the machine 100 – 200 mm (4 – 8 in) from the ground, then stop and check that the machine is horizontal and that there is no looseness in the wire cable.
- Before lifting the machine, always stop the engine, apply the parking brake, and lock the frames with the safety bar to prevent the front frame from turning.
- When lifting, check that there is no looseness in counter-weight mounting bolts ①. Tighten any loose bolts.

	WA20, 30, 40	WA50
Bolt	2	4
Tightening torque	490 – 608N•m (50 – 62 kgf•m)	

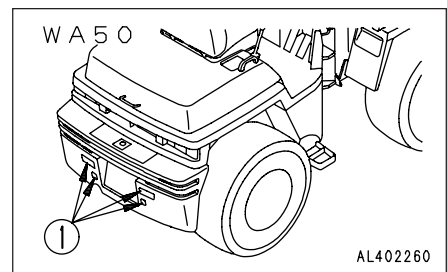
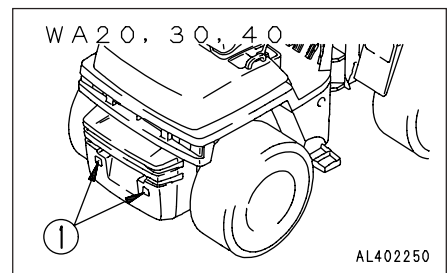

⚠ WARNING

- Never raise the machine with any worker on it.
- Always make sure that the wire rope used for lifting the machine is of ample strength for the weight of the machine.
- Never try to lift the machine in any posture other than the posture given in the procedure below. There is danger that the machine may lose its balance.
- When lifting the machine, be careful of the position of the center of gravity and always maintain the balance.

NOTICE

- For weight, see “25. SPECIFICATIONS”.
- Specifications value indicates the standard specifications. When installing the attachment, or optional equipment, lifting method has been changed; consult Komatsu or your Komatsu distributor for details.

13.4.1 POSITION FOR ATTACHING HOOK MARK LABELS

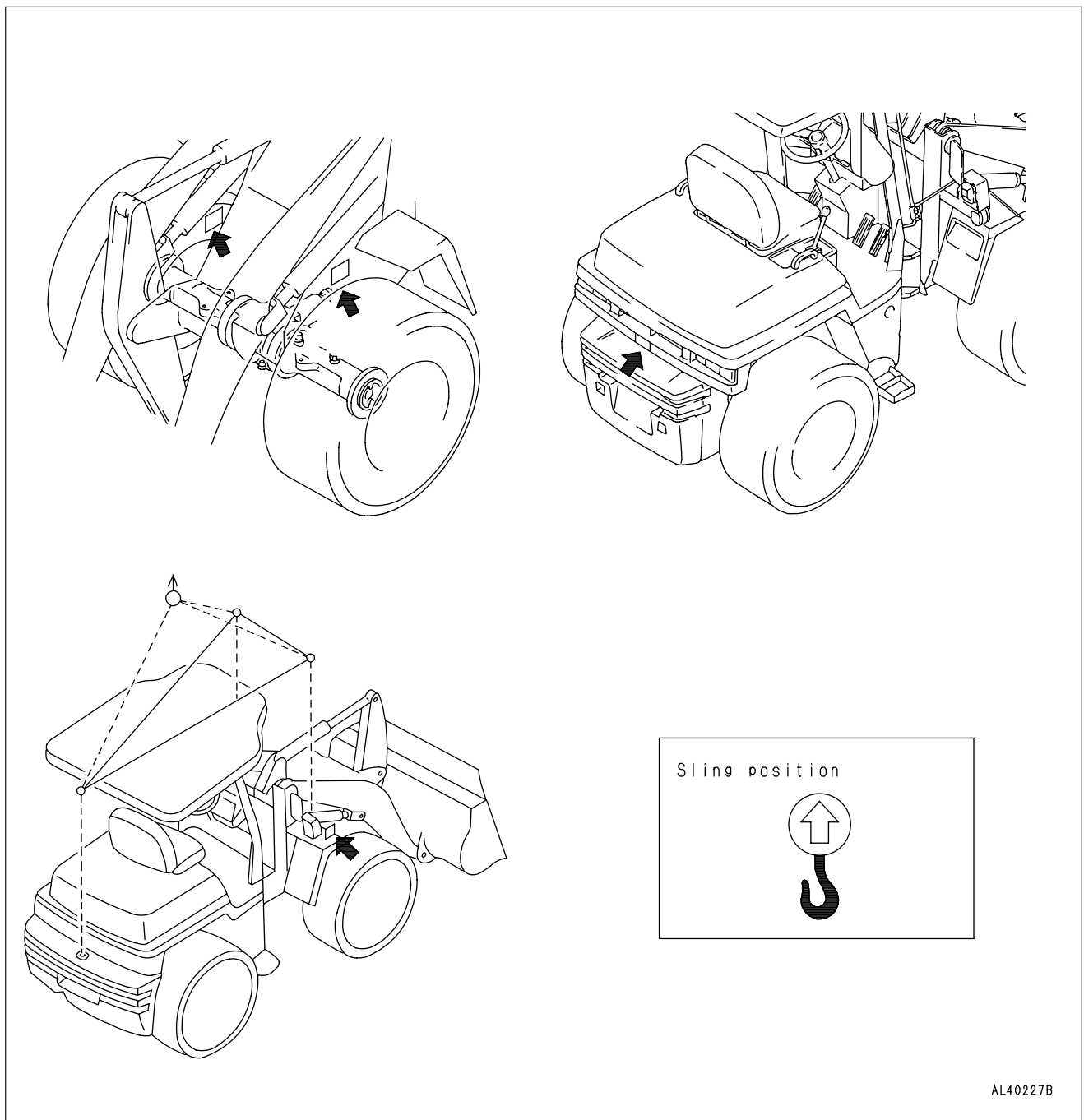

AL40227B

For details of the machine weight, see "25. SPECIFICATIONS".

13.4.2 METHOD OF LIFTING MACHINE

The machine can be lifted only if it has hook mark labels. When lifting the machine, stop the machine on level ground and do as follows.

1. Start the engine, set the machine horizontal, then set the work equipment to the travel posture (see "12.4 STARTING MACHINE").

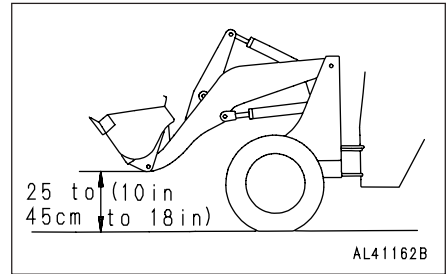

2. Apply the safety lock to the work equipment control lever.

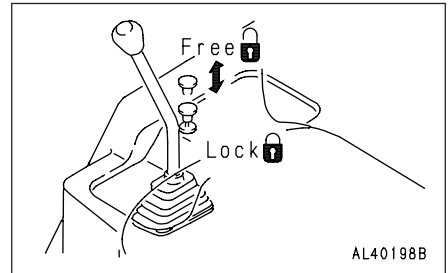

3. Depress the parking brake pedal fully to apply the parking brake.

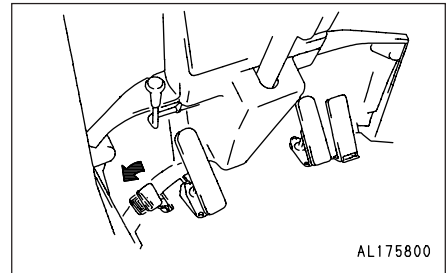

4. Stop the engine, check that the area around the operator's compartment is safe, then lock the frame with the safety bar so that the front and rear frames do not bend.

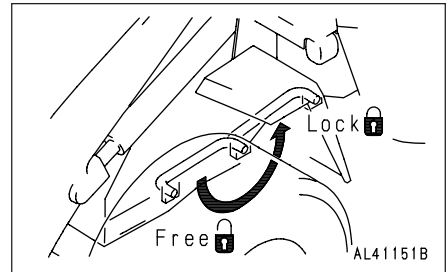

5. Fit the lifting equipment to the following 3 places (places with hook mark) : left and right front axle, and towing pin.

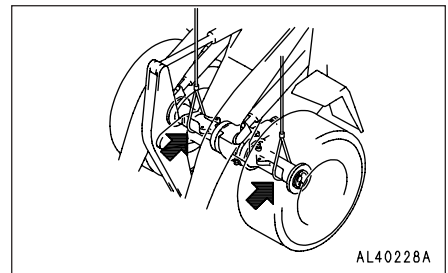

6. When the machine comes off the ground, stop lifting and check carefully that the machine is balanced, then lift slowly.

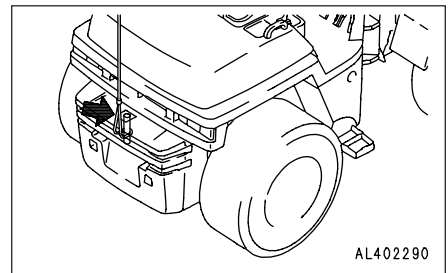

CAUTION
 When lifting the machine, check that there is no leakage of oil from the hydraulic circuits.

13.4 PRECAUTIONS FOR TRANSPORTATION

⚠ WARNING

Determine the route for transporting the machine by taking into account the width, height and weight of the machine.

Obey all state and local laws governing the weight, width and length of a load. Observe all regulations governing wide loads.

13.5 REMOVING AND INSTALLATION OF CANOPY

⚠ WARNING

Precautions for removal and installation

When removing or installing the canopy, observe the following precautions and take steps to ensure safety during the operation.

- Carry out the removal and installation operation on hard level ground.
- When carrying out the operation with two or more workers, decide signals and always follow these signals during the operation.
- Weight of parts: Pole 9 kg (18 lb) (each), roof 15 kg (30 lb)
- When removing parts, always check that the parts are properly supported before starting to remove.
- When parts have been removed or when they are to be installed, set them in a stable position so that they will not fall over.
- When installing the canopy, tighten the canopy mounting bolts securely. If the bolts are loose, there is danger that the canopy may fall off.

REMOVING

1 Support roof ① to prevent it from tipping or falling.

2 Remove 4 roof mounting bolts ②, then remove roof ①.

Roof weight: 15 kg (30 lb)

3. Secure pole ③ so that it does not fall, then remove 4 pole mounting bolts ④ and remove pole ③.

Pole weight: 9 kg (18 lb)

4. Remove pole ⑤ in the same way as pole ③.

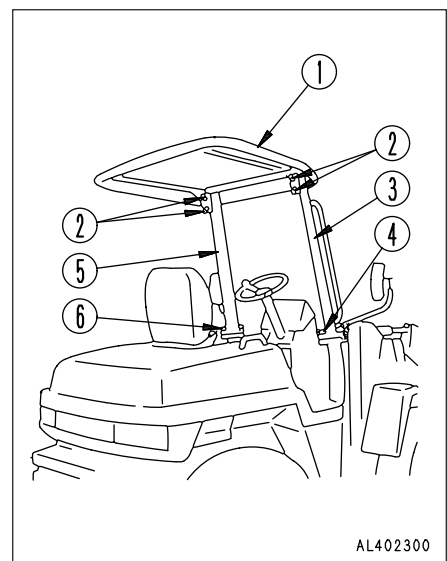

INSTALLATION

1. Install pole ① with 8 bolts ② and 8 washers.

Tightening torque: 59 to 74 N•m (6 to 7.5 kgf•m)

Pole weight: 9 kg (18 lb)

2. Install roof ④ with 4 bolts ⑤ and 4 washers.

Tightening torque: 59 to 74 N•m (6 to 7.5 kgf•m)

Roof weight: 15 kg (30 lb)

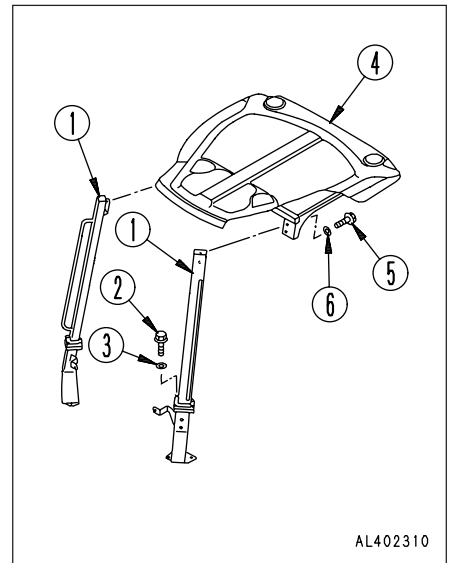

14. COLD WEATHER OPERATION

14.1 PRECAUTIONS FOR LOW TEMPERATURE

If the temperature becomes low, it becomes difficult to start the engine, and the coolant may freeze, so do as follows.

14.1.1 FUEL AND LUBRICANTS

Change to fuel and oil with low viscosity for all components. For details of the specified viscosity, see "20. USE OF FUEL, COOLANT AND LUBRICANTS ACCORDING TO AMBIENT TEMPERATURE".

14.1.2 COOLANT

 **WARNING**

Keep antifreeze fluid away from an open flame. Never smoke when using antifreeze.

NOTICE

- **Never use methanol, ethanol or propanol based antifreeze.**
- **Absolutely avoid using any water leak preventing agent irrespective of whether it is used independently or mixed with an antifreeze.**
- **Do not mix one antifreeze with a different brand.**

For details of the antifreeze mixture when changing the coolant, see "24.2 WHEN REQUIRED".

Use a Permanent Antifreeze (ethylene glycol mixed with corrosion inhibitor, antifoam agent, etc.) meeting the standard requirements as shown below. With permanent antifreeze, no change of coolant is required for a year. If it is doubtful that an available antifreeze meets the standard requirements, ask the supplier of that antifreeze for information.

Standard requirements for permanent antifreeze

- SAE J1034
- FEDERAL STANDARD O-A-548D

REMARK

Where no permanent antifreeze is available, an ethylene glycol antifreeze without corrosion inhibitor may be used only for the cold season. In this case, clean the cooling system twice a year (in spring and autumn). When refilling the cooling system, add antifreeze in autumn, but do not add any in spring.

14.1.3 BATTERY

⚠ WARNING

- To avoid gas explosions, do not bring fire or sparks near the battery.
- Battery electrolyte is dangerous. If it gets in your eyes or on your skin, wash it off with large amounts of water, and consult a doctor.

When the ambient temperature drops, the capacity of the battery will also drop. If the battery charge ratio is low, the battery electrolyte may freeze. Maintain the battery charge as close as possible to 100%, and insulate it against cold temperature so that the machine can be started easily the next morning.

REMARK

Measure the specific gravity and calculate the rate of charge from the following conversion table.

Temp. of fluid Rate of charge	20°C	0°C	-10°C	-20°C	-30°C
100%	1.28	1.29	1.30	1.31	1.32
90%	1.26	1.27	1.28	1.29	1.30
80%	1.24	1.25	1.26	1.27	1.28
75%	1.23	1.24	1.25	1.26	1.27

14.2 PRECAUTIONS AFTER COMPLETION OF WORK

To prevent mud, water, or the undercarriage from freezing and making it impossible for the machine to move on the following morning, always observe the following precautions.

- Mud and water on the machine body should be completely removed.
This is to prevent damage to the seal caused by water in mud or dirt getting inside the seal and freezing.
- Park the machine on hard, dry ground.
If this is impossible, park the machine on wooden boards.
The boards help protect the tracks from being frozen in the soil and the machine can start next morning.
- Open the drain valve and drain any water collected in the fuel system to prevent it from freezing.
- As the battery capacity drops markedly in low temperatures, cover the battery or remove it from the machine, keep it in a warm place, and install it again the next morning.

14.3 AFTER COLD WEATHER

When season changes and the weather becomes warmer, do as follows.

- Replace the fuel and oil for all parts with oil of the viscosity specified.
For details, see "20. USE OF FUEL, COOLANT AND LUBRICANTS ACCORDING TO AMBIENT TEMPERATURE".
- If for any reason permanent antifreeze cannot be used, and an ethyl glycol base antifreeze (winter, one season type) is used instead, or if no antifreeze is used, drain the cooling system completely, then clean out the inside of the cooling system thoroughly, and fill with fresh water.

15. LONG-TERM STORAGE

15.1 BEFORE STORAGE

When putting the machine in storage for a long time, do as follows.

- After every part is washed and dried, house the machine in a dry building. Never leave it outdoors.
If the machine must be left outdoors, park it on well-drained concrete and cover it with canvas, etc.
- Completely fill the fuel tank, lubricate, and change the oil before storage.
- Apply a thin coat of grease to the metal surface of the hydraulic piston rods.
- Disconnect the negative terminals of the battery and cover it, or remove it from the machine and store it separately.
- If the ambient temperature is expected to drop below 0°C, always add antifreeze to the cooling water.
- Apply the safety locks to the work equipment control lever and directional lever, then apply the parking brake.

15.2 DURING STORAGE

 **WARNING**

If it is unavoidably necessary to carry out the rust-prevention operation while the machine is indoors, open the doors and windows to improve ventilation and prevent gas poisoning.

Operate the engine and move the machine for a short distance once a month so that a new film of oil will be coated over movable parts and component surfaces. At the same time, also charge the battery.

Before operating the work equipment, wipe off the grease on the hydraulic piston rod.

15.3 AFTER STORAGE

NOTICE

If the machine is stored without carrying out the monthly rust prevention operation, request your Komatsu distributor for service.

Carry out the following procedure when taking the machine out of long-term storage.

- Wipe off the grease from the hydraulic cylinder rods.
- Add oil and grease to all places.

16. TROUBLESHOOTING

16.1 WHEN MACHINE RUNS OUT OF FUEL

⚠ WARNING

The engine will start, so check carefully that the area around the engine is safe before cranking the engine.

If the machine has run out of fuel, add fuel and then bleed the air from the fuel system before starting the engine.

PROCEDURE FOR BLEEDING AIR

Turn the key in the starting switch to the START position and crank the engine for 15 – 20 seconds. Repeat this procedure 3 – 4 times to bleed the air.

Do not turn the starting motor continuously for more than 20 seconds. Wait for 2 minutes before turning the starting motor again.

The air can be bled more quickly if the fuel tank is completely filled with fuel.

The air can be bled by hand-moving feed pump lever ① up and down.

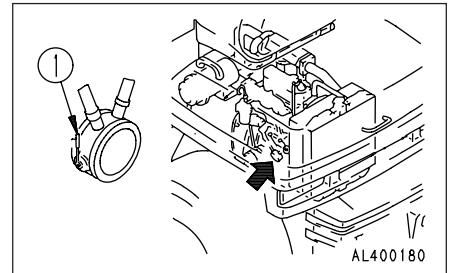

16.2 TOWING THE MACHINE

WARNING

- If the machine that has broken down is towed in the wrong way, it may lead to serious injury or damage.
- If there is a failure in the brake line, the brakes cannot be used, so be extremely careful when towing.

NOTICE

- Towing is for moving the machine to a place where inspection and maintenance can be carried out, and not for moving it long distances.
The machine must not be towed for long distances.
- For details of the procedure for towing a machine when it has broken down, please contact your Komatsu distributor.

This machine must not be towed except in emergencies. When towing the machine, take the following precautions.

- When releasing the brakes, put blocks under the wheels to prevent the machine from moving. If the wheels are not blocked, the machine may suddenly move.
- When towing a machine, tow it at a low speed of less than 2 km/h (1.24 MPH), and for a distance of a few meters to a place where repairs can be carried out. The machine should be towed only in emergencies.
If the machine must be moved long distances, use a transporter.
- Fit a guard plate to the machine being towed to protect the operator if the tow rope or bar should break.
- If the steering and brake of the machine being towed cannot be operated, do not let anyone sit on the machine.
- Check that the tow rope or bar is of ample strength for the weight of the machine being towed. If the machine being towed must travel through mud or up hills, use a tow rope or bar of a strength of at least 1.5 times the weight of the machine being towed.

- Keep the angle of the tow rope as small as possible. Keep the angle between the center lines of the two machines to within 30°.
- If the machine is moved suddenly, an excessive load will be applied to the tow rope or bar, and it may break. Always move the machine slowly at a fixed speed.
- The towing machine should normally be of the same class as the machine being towed. Check that the towing machine has ample braking power, weight, and rimpull to allow it to control both machine on slopes or on the tow road.
- When towing a machine downhill, use a larger machine for towing to provide ample rimpull and braking power, or connect another machine to the rear of the machine being towed. In this way it is possible to prevent the machine from losing control and turning over.
- Towing may be carried out under various differing conditions, so it is impossible to determine beforehand the requirements for towing. Towing on flat horizontal roads will require the minimum rimpull, while towing on slopes or on uneven road surfaces will require the maximum rimpull.

16.2.1 WHEN ENGINE CAN BE USED

- If the transmission and steering wheel can be operated, and the engine is running, it is possible to tow the machine out of mud or to move it for a short distance to the edge of the road.
- The operator should sit on the machine being towed and operate the steering in the direction that the machine is towed.

16.2.2 WHEN ENGINE CANNOT BE USED

- The steering cannot be operated, so remove the steering cylinder.
- Tow the machine slowly at a maximum speed of 2 km/h.
- The following two methods can be used when towing the machine after the engine has stopped. Select the method which is best suited for the condition of the machine.
 - When removing drive shaft
The HST motor is not actuated, so remove the front and rear drive shafts.
 - When short circuiting main HST circuit
In this case, it is always necessary to readjust the high pressure safety valve, so please contact your Komatsu distributor.

(1) Remove the floor mat and plate, and check the location of the 2 HST pump high-pressure safety valves.

(2) Remove cap nut ① from the high-pressure safety valve, then loosen locknut ② and turn adjustment screw ③ 5 turns counterclockwise.
Loosen both high-pressure safety valves.

- Be sure to connect the machine up securely for towing. When carrying out towing operations, use two machines of at least the same class as the machine being towed. Connect one machine each to the front and rear of the machine being towed, release the parking brake on the machine being towed, then remove the blocks from under the tires and tow the machine.

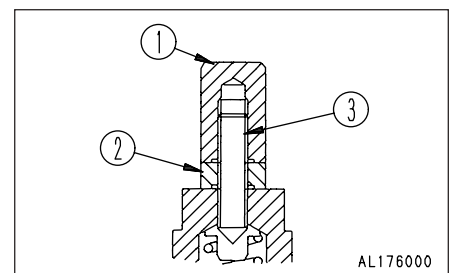
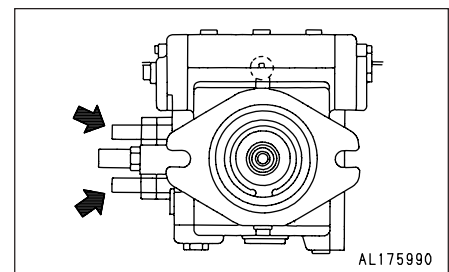

16.3 IF BATTERY IS DISCHARGED

⚠ WARNING

- When checking or handling the battery, stop the engine and turn the starting switch key to the OFF position before starting.
- Before starting the engine, use a damp cloth to wipe off the dust accumulated on the top surface of the battery.
- The battery generates hydrogen gas, so there is danger of explosion. Do not bring lighted cigarettes near the battery, or do anything that will cause sparks.
- Battery electrolyte is dilute sulphuric acid, and it will attack your clothes and skin. If it gets on your clothes or on your skin, wash it immediately off with large amounts of water. If it gets in your eyes, wash it out with fresh water, and consult a doctor.
- When handling battery, always wear protective goggles.
- When removing the battery, first disconnect the cable from the ground (normally, from the negative \ominus terminal). When installing, install the positive \oplus terminal first. If a tool touches the cable connecting the positive terminal and the chassis, there is danger that it will cause sparks.
- If the terminals are loose, there is danger that the defective contact may generate sparks that will cause an explosion. When installing the terminals, install them tightly.
- When removing or installing, check which is the positive \oplus terminal and negative \ominus terminal.

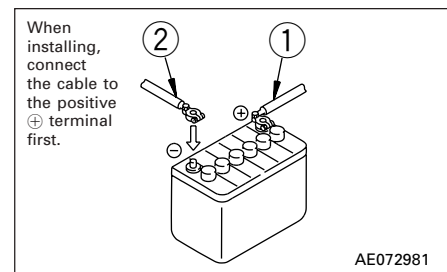
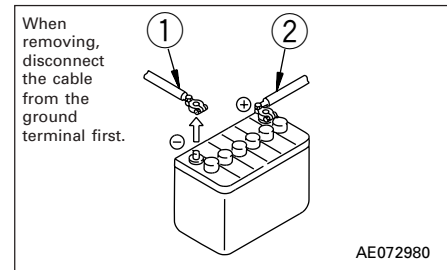

16.3.1 REMOVAL AND INSTALLATION OF BATTERY

When starting the engine with a booster cable, do as follows:

- When removing battery, first disconnect the cable from the ground (normally, from the negative \ominus terminal). If a tool touches a cable connecting the positive terminal and the chassis, there is danger of sparks being emitted.
- When installing battery, the ground cable should be connected to the ground terminal as the last step.

16.3.2 PRECAUTIONS FOR CHARGING BATTERY

CHARGING BATTERY WHEN MOUNTED ON MACHINE

- Before charging, disconnect the cable from the negative \ominus terminal of the battery. Otherwise, an unusually high voltage will damage the alternator.
- While charging the battery, remove all battery plugs for satisfactory ventilation.
To avoid gas explosions, do not bring fire or sparks near the battery.
- If the electrolyte temperature exceeds 45°C, stop charging for a while.
- Turn off the charger as soon as the battery is charged.
Overcharging the battery may cause the following:
 - 1) Overheating the battery
 - 2) Decreasing the quantity of electrolyte.
 - 3) Damaging the electrode plate.
- Do not mix the cables (positive \oplus to negative \ominus or negative \ominus to positive \oplus), as it will damage the alternator.
- When performing any service to the battery besides checking the electrolyte level or measuring the specific gravity, disconnect cables from the battery.

16.3.3 STARTING ENGINE WITH BOOSTER CABLE

When starting the engine with a booster cable, do as follows:

PRECAUTIONS WHEN CONNECTING AND DISCONNECTING BOOSTER CABLE

WARNING

- When connecting the cables, never contact the positive ⊕ and negative ⊖ terminals.
- When starting the engine with a booster cable, always wear safety glasses.
- Be careful not to let the normal machine and problem machine contact each other. This prevents sparks from generating near the battery which could ignite the hydrogen gas given off by the battery. If hydrogen gas explodes, it could cause serious injury.
- Make sure that there is no mistake in the booster cable connections. The final connection is to the engine block of the problem machine, but sparks will be generated when this is done, so connect to a place as far as possible from the battery.
- Use care when removing the cables from the machine that has been started. Do not allow the cable ends to contact each other or the machine, to avoid hydrogen explosion.

INCORRECT

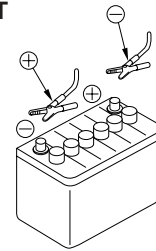

A0067322

NOTICE

- The size of the booster cable and clip should be suitable for the battery size.
- The battery of the normal machine must be the same capacity as that of the engine to be started.
- Check the cables and clips for damage or corrosion.
- Make sure that the cables and clips are firmly connected.

Connecting the booster cables

Keep the starting switch at the OFF position.

Connect the booster cable as follows, in the order of the numbers marked in the diagram.

1. Make sure that the starting switches of the normal machine and problem machine are both at the OFF position.
2. Connect one clip of booster cable (A) to the positive (+) terminal of the problem machine.
3. Connect the other clip of booster cable (A) to the positive (+) terminal of the normal machine.
4. Connect one clip of booster cable (B) to the negative (-) terminal of the normal machine.
5. Connect the other clip of booster cable (B) to the engine block of the problem machine.

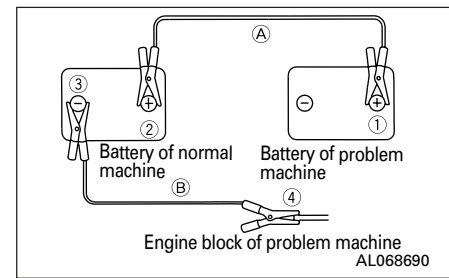
**Starting the engine**

1. Make sure the clips are firmly connected to the battery terminals.
2. Start the engine of the normal machine and keep it to run at high idling speed.
3. Turn the starting switch of the problem machine to the START position and start the engine. If the engine doesn't start at first, try again after 2 minutes or so.

Disconnecting the booster cables

After the engine has started, disconnect the booster cables in the reverse of the order in which they were connected.

1. Remove one clip of booster cable (B) from the engine block of the problem machine.
2. Remove the other clip of booster cable (B) from the negative (-) terminal of the normal machine.
3. Remove one clip of booster cable (A) from the positive (+) terminal of the normal machine.
4. Remove the other clip of booster cable (A) from the positive (+) terminal of the problem machine.

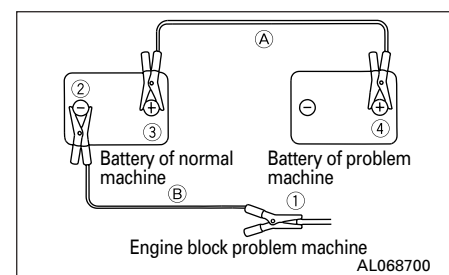

16.4 OTHER TROUBLE

16.4.1 ELECTRICAL SYSTEM

- (): Always contact your Komatsu distributor when dealing with these items.
- In cases of abnormalities or causes which are not listed below, please contact your Komatsu distributor for repairs.

Problem	Main causes	Remedy
Lamp does not glow brightly even when the engine runs at high speed	<ul style="list-style-type: none"> ● Defective wiring ● Defective adjustment of fan belt tension 	<ul style="list-style-type: none"> ● Check, repair loose terminals, disconnections) ● Adjust fan belt tension For details, see EVERY 250 HOURS SERVICE
Lamp flickers while engine is running		
Abnormal noise is generated from alternator	<ul style="list-style-type: none"> ● Defective alternator 	<ul style="list-style-type: none"> ● Replace)
Starting motor does not turn when starting switch is turned to ON	<ul style="list-style-type: none"> ● Defective wiring ● Insufficient battery charge 	<ul style="list-style-type: none"> ● Check, repair) ● Charge
Pinion of starting motor keeps going in and out	<ul style="list-style-type: none"> ● Insufficient battery charge 	<ul style="list-style-type: none"> ● Charge
Starting motor turns engine sluggishly	<ul style="list-style-type: none"> ● Insufficient battery charge ● Defective starting motor 	<ul style="list-style-type: none"> ● Charge ● Replace)
Starting motor disengages before engine starts	<ul style="list-style-type: none"> ● Defective wiring ● Insufficient battery charge 	<ul style="list-style-type: none"> ● Check, repair) ● Charge
Preheating pilot lamp does not light up	<ul style="list-style-type: none"> ● Defective wiring ● Defective glow relay, glow controller, water temperature sensor ● Defective preheating pilot lamp 	<ul style="list-style-type: none"> ● Check, repair) ● Replace) ● Replace)
Even when engine is stopped, engine oil pressure caution pilot lamp does not light up (starting switch at ON position)	<ul style="list-style-type: none"> ● Defective caution pilot lamp ● Defective caution pilot lamp switch 	<ul style="list-style-type: none"> ● Replace) ● Replace)

16.4.2 CHASSIS

- (): Always contact your Komatsu distributor when dealing with these items.
- In cases of abnormalities or causes which are not listed below, please contact your Komatsu distributor for repairs.

Problem	Main causes	Remedy
HST		
Engine is running but machine does not move	<ul style="list-style-type: none"> ● Parking brake is applied ● Directional lever is not shifted properly ● No electricity flows to directional lever (electrical type) ● Lack of oil in hydraulic tank ● Inching control linkage disconnected 	<ul style="list-style-type: none"> ● Release parking brake ● Shift lever properly ● Check fuses and wiring harness connector ● Add oil to specified level. See 250 HOURS SERVICE. ● Connect linkage (check brake control)
Even when engine is run at full throttle, machine only move slowly and lacks power	<ul style="list-style-type: none"> ● Lack of oil in hydraulic tank ● Inching control linkage disconnected ● Hydraulic oil temperature is low 	<ul style="list-style-type: none"> ● Add oil to specified level. See 250 HOURS SERVICE. ● Connect linkage (check brake control) ● Carry out warming-up operation
Oil overheats	<ul style="list-style-type: none"> ● Too much oil or too little oil ● Clogged oil cooler core 	<ul style="list-style-type: none"> ● Add or drain oil to specified level. See WHEN REQUIRED ● Clean oil cooler core
Noise generated	<ul style="list-style-type: none"> ● Lack of oil 	<ul style="list-style-type: none"> ● Add oil to specified level. See WHEN REQUIRED
Axle		
Noise generated	<ul style="list-style-type: none"> ● Lack of oil 	<ul style="list-style-type: none"> ● Add oil to specified level. See WHEN REQUIRED

CHASSIS continued (16.4.2)

Problem	Main causes	Remedy
Wet type disc brake		
Brake is not applied when pedal is depressed	<ul style="list-style-type: none"> ● Brake linkage disconnected ● Disc has reached wear limit 	<ul style="list-style-type: none"> ● Connect linkage (check brake control) (● Replace disc)
Brake drags or remains applied	<ul style="list-style-type: none"> ● Improper adjustment of brake pedal linkage 	<ul style="list-style-type: none"> ● Adjust (check brake control)
Parking brake		
Braking effect is poor	<ul style="list-style-type: none"> ● Linkage is loose ● Disc is worn 	<ul style="list-style-type: none"> ● Adjust (check brake control) (● Replace disc)
Hydraulic system		
Lack of lifting power for bucket	<ul style="list-style-type: none"> ● Lack of oil 	<ul style="list-style-type: none"> ● Add oil to specified level. See EVERY 250 HOURS SERVICE
Bucket takes time to rise	<ul style="list-style-type: none"> ● Clogged hydraulic tank filter 	<ul style="list-style-type: none"> ● Replace filter. See EVERY 1000 HOURS SERVICE
Excessive bubbles in oil	<ul style="list-style-type: none"> ● Low quality oil being used ● Oil level is low ● Air in oil line 	<ul style="list-style-type: none"> ● Replace with good quality oil ● Add oil to specified level. See EVERY 250 HOURS SERVICE ● Bleed air. See EVERY 1000 HOURS SERVICE
Hydraulic pressure is low	<ul style="list-style-type: none"> ● Oil level is low and pump is sucking in air 	<ul style="list-style-type: none"> ● Add oil to specified level. See EVERY 250 HOURS SERVICE Then bleed air. See EVERY 1000 HOURS SERVICE
Movement of cylinder is irregular	<ul style="list-style-type: none"> ● Oil level is low 	<ul style="list-style-type: none"> ● Add oil to specified level. See EVERY 250 HOURS SERVICE

16.4.3 ENGINE

- (): Always contact your Komatsu distributor when dealing with these items.
- In cases of abnormalities or causes which are not listed below, please contact your Komatsu distributor for repairs.

Problem	Main causes	Remedy
Engine oil pressure caution pilot lamp lights up	<ul style="list-style-type: none"> ● Engine oil pan oil level is low (sucking in air) ● Clogged oil filter cartridge ● Defective tightening of oil pipe joint, oil leakage from damaged part ● Defective pilot lamp 	<ul style="list-style-type: none"> ● Add oil to specified level, see CHECK BEFORE STARTING ● Replace cartridge, see EVERY 500 HOURS SERVICE (● Check, repair) (● Replace)
Steam is emitted from top part of radiator (pressure valve)	<ul style="list-style-type: none"> ● Cooling water level low, water leakage ● Loosen fan belt ● Dirt or scale accumulated in cooling system 	<ul style="list-style-type: none"> ● Add cooling water, repair, see CHECK BEFORE STARTING ● Adjust fan belt tension, see EVERY 250 HOURS SERVICE ● Change cooling water, clean inside of cooling system, see WHEN REQUIRED
Water temperature gauge is in red (H) range	<ul style="list-style-type: none"> ● Clogged radiator fin or damaged fin ● Defective thermostat ● Loose radiator filler cap (high altitude operation) ● Defective water level sensor 	<ul style="list-style-type: none"> ● Clean or repair, see WHEN REQUIRED (● Replace thermostat) ● Tighten cap or replace packing (● Replace sensor)
Water temperature gauge is under white range (C)	<ul style="list-style-type: none"> ● Defective thermostat ● Defective monitor 	<ul style="list-style-type: none"> (● Replace thermostat) (● Replace)
Engine does not start when starting motor is turned	<ul style="list-style-type: none"> ● Lack of fuel ● Air in fuel system ● Defective fuel injection pump or nozzle ● Starting motor cranks engine sluggishly ● Defective stop solenoid valve ● Defective compression <ul style="list-style-type: none"> ○ Defective valve clearance 	<ul style="list-style-type: none"> ● Add fuel, see CHECK BEFORE STARTING ● Repair replace where air is sucked in (● Replace pump or nozzle) ● See ELECTRICAL SYSTEM (● Check, replace) (○ Adjust valve clearance)
Exhaust gas is white or blue	<ul style="list-style-type: none"> ● Too much oil in oil pan ● Improper fuel 	<ul style="list-style-type: none"> ● Add oil to specified level, see CHECK BEFORE STARTING ● Change to specified fuel

ENGINE continued (16.4.3)

Problem	Main causes	Remedy
Exhaust gas occasionally turns black	<ul style="list-style-type: none"> ● Clogged air cleaner element ● Defective nozzle ● Defective compression 	<ul style="list-style-type: none"> ● Clean or replace, see WHEN REQUIRED (● Replace nozzle) (● See defective compression above)
Combustion noise occasionally makes breathing sound	<ul style="list-style-type: none"> ● Defective nozzle 	<ul style="list-style-type: none"> (● Replace nozzle)
Abnormal noise generated (combustion or mechanical)	<ul style="list-style-type: none"> ● Low grade fuel being used ● Overheating ● Damage inside muffler ● Excessive valve clearance 	<ul style="list-style-type: none"> ● Change to specified fuel ● Refer to "Water temperature gauge is in red range" as above (● Replace muffler) (● Adjust valve clearance)

MAINTENANCE

17. GUIDES TO MAINTENANCE

Do not carry out any inspection and maintenance operation that is not given in this manual.

Perform maintenance work on hard, flat ground.

Set to the inspection and maintenance posture.

Always carry out operations with the machine in the following posture unless otherwise specified.

- Lower the work equipment to the ground and set in the posture shown in the diagram on the right.
- Set all control levers to the neutral or HOLD position.
- Set the safety lever to the LOCK position.
- Press the parking brake switch to apply the parking brake.
- Put blocks in front and behind the tires.
- Lock the front and rear frames with the safety bar.

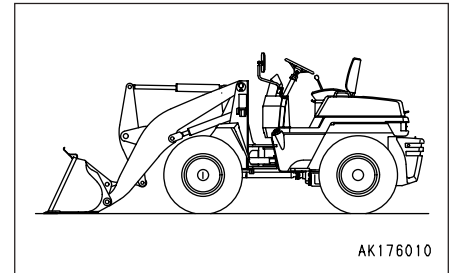

Check service meter:

Check the service meter reading every day to see if the time has come for any necessary maintenance to be carried out.

Komatsu genuine replacement parts:

Use Komatsu genuine parts specified in the Parts Book as replacement parts.

Komatsu genuine oils:

Use Komatsu genuine oils and grease. Choose oils and grease with proper viscosities specified for ambient temperature.

Always use clean washer fluid:

Use automobile window washer fluid and be careful not to let any dirt get into it.

Always use clean oil and grease:

Use clean oil and grease. Also, keep containers of the oil and grease clean. Keep foreign materials away from oil and grease.

Keeping the machine clean:

Always keep the machine clean. This makes it easier to find parts causing problems. In particular, keep grease fittings, breathers and oil level gauges clean and avoid foreign materials from getting in them.

Be careful of hot water and oil:

Draining hot oils and coolants and removing their filters immediately after the engine stops are hazardous. Allow the engine to cool.

If the oil has to be drained when it is cold, warm up the oil to a suitable temperature (approx. 20 – 40°C) before draining it.

Checking foreign materials in drained oil and on filters:

After oil is changed or filters are replaced, check the oil and filters for metallic particles and foreign materials. If large quantities of metallic particles or foreign materials are found, consult your Komatsu distributor.

Fuel strainer:

If your machine is equipped with a fuel strainer, do not remove it while fueling.

Oil change:

Check or change oils in the places where dust is scarce to keep foreign materials away from oils.

Warning tag:

Attach the warning tag to the starting switch or other appropriate control lever to prevent anyone from starting the engine during maintenance.

Obey precautions:

During the operation, always obey the precautions on the safety label attached to the machine.

Welding instructions:

- Turn off the engine starting switch.
- Do not apply more than 200 V continuously.
- Connect grounding the cable within 1 m (3.28 ft) from the area to be welded.
- Avoid seals or bearings from being between the area to be welded and the position of the grounding point.
- Never weld any pipe or tube containing fuel or oil.

Fire prevention:

Use nonflammable cleaner or light oil for cleaning parts. Keep flame or cigarette light away from light oil.

Clamp faces:

When O-rings or gaskets are removed, clean the clamp faces and replace the O-rings and gaskets with new ones. Be sure to fit O-rings and gaskets when assembling.

Objects in your pockets:

Keep your pockets free of loose objects which can fall out and drop into the machinery; especially when you work on the machinery while bending over it.

Checking undercarriage:

When working in rocky areas, check for damage to the undercarriage and for looseness, flaws, wear and damage in bolts and nuts.

Precautions when washing machine:

- Never spray steam or water directly at the radiator.
- Do not allow water to get on any electrical component.

Pre-and post-work checks:

Before starting work in mud, rain, snow or at the seashore, check plugs and valves for tightness.

Wash the machine immediately after the work to protect components from rusting.

Lubricate components more frequently than usual. Be sure to lubricate work equipment pins daily if they are submerged in water.

On jobsites where heavy-duty operations are common, reduce the maintenance intervals and carry out greasing more frequently.

Dusty worksites:

When working at dusty worksites, do as follows:

- Inspect the air cleaner clogging portion pilot lamp to see whether the air cleaner is blocked up. Clean the air cleaner at shorter intervals than specified.
- Clean the radiator core frequently to avoid clogging.
- Clean and replace the fuel filter frequently.
- Clean electrical components, especially the starting motor and alternator, to avoid accumulation of dust.

Avoid mixing oils:

Never mix oils of different brands. If you have only oil which is a different brand from the one that is used in the machine, do not add it but replace all the oil.

18. OUTLINES OF SERVICE

- Use Komatsu genuine parts for replacement.
- When changing or adding oil, do not use a different type of oil.
- Unless otherwise specified, the oil and coolant used at the time of shipment from the factory are as shown in the table below.

Item	Kind of fluid
Engine oil pan	SAE 10W-30 API classification CD
Transmission case	SAE 10W-30 API classification CD
Axle (Front and rear)	AXO75
Brake	SAE 5W API classification CD
Hydraulic tank	SAE 10W-30 API classification CD
Pins	Lithium base EP grease No. 2
Fuel	ASTM D975 No. 2 (However, ASTM D975 No. 1 is used for the winter season (October to March))
Radiator	Komatsu Super Coolant (AF-ACL) above 30% added to water

18.1 OUTLINE OF OIL, FUEL, COOLANT

18.1.1 OIL

- Oil is used in the engine and work equipment under extremely severe conditions (high temperature, high pressure), and it deteriorates with use.
Always use oil that matches the grade and temperature for use given in the Operation and Maintenance Manual. Even if the oil is not dirty, always replace the oil after the specified interval.
- Oil corresponds to blood in the human body, so always be careful when handling it to prevent any impurities (water, metal particles, dirt, etc.) from getting in.
The majority of problems with machine are caused by the entry of such impurities.
Take particular care not to let any impurities get in when storing or adding oil.
- Never mix oils of different grades or brands.
- Always add the specified amount of oil.
Having too much oil or too little oil are both causes of problems.
- If the oil in the work equipment is not clear, there is probably water or air getting into the circuit.
In such cases, please contact your Komatsu distributor.
- When changing the oil, always replace the related filters at the same time.
- We recommend you to have an analysis made of the oil periodically to check the condition of the machine. For those who wish to use this service, please contact your Komatsu distributor.

18.1.2 FUEL

- The fuel pump is a precision instrument, and if fuel containing water or dirt is used, it cannot work properly.
- Be extremely careful not to let impurities get in when storing or adding fuel.
- Always use the fuel specified in the Operation and Maintenance Manual.
Fuel may congeal depending on the temperature when it is used (particularly in low temperature below -15°C), so it is necessary to change to a fuel that matches the temperature.
- To prevent the moisture in the air from condensing and forming water inside the fuel tank, always fill the fuel tank after completing the day's work.
- Before starting the engine, or when 10 minutes have passed after adding fuel, drain the sediment and water from the fuel tank.
- If the engine runs out of fuel, or if the filters have been replaced, it is necessary to bleed the air from the circuit.

18.1.3 COOLANT

- River water contains large amounts of calcium and other impurities, so if it is used, scale will stick to the engine and radiator, and this will cause defective heat exchange and overheating.
Do not use water that is not suitable for drinking.
- When using anti-freeze, always observe the precautions given in the Operation and Maintenance Manual.
- Komatsu machines are supplied with Komatsu original anti-freeze in the coolant when the machine is shipped.
This anti-freeze is effective in preventing corrosion of the cooling system.
The anti-freeze can be used continuously for two years or 4000 hours. Therefore, it can be used as it is even in hot areas.
- Anti-freeze is flammable, so be extremely careful not to expose it to flame or fire.
- The proportion of anti-freeze to water differs according to the ambient temperature.
For details of the mixing proportions, see "24.2.2 CLEAN INSIDE OF COOLING SYSTEM".
- If the engine overheats, wait for the engine to cool before adding coolant.
- If the coolant level is low, it will cause overheating and will also cause problems with corrosion from the air in the coolant.

18.1.4 GREASE

- Grease is used to prevent twisting and noise at the joints.
- The nipples not included in the maintenance section are nipples for overhaul, so they do not need grease.
If any part becomes stiff after being used for long time, add grease.
- Always wipe off all of the old grease that is pushed out when greasing. Be particularly careful to wipe off the old grease in places where sand or dirt sticking in the grease would cause wear of the rotating parts.

18.1.5 STORING OIL AND FUEL

- Keep indoors to prevent any water, dirt, or other impurities from getting in.
- When keeping drum cans for a long period, put the drum on its side so that the filler port of the drum can is at the side. (To prevent moisture from being sucked in)
If drum cans have to be stored outside, cover them with a waterproof sheet or take other measures to protect them.
- To prevent any change in quality during long-term storage, be sure to use in the order of first in - first out (use the oldest oil or fuel first).

18.1.6 FILTERS

- Filters are extremely important safety parts. They prevent impurities in the fuel and air circuits from entering important equipment and causing problems.
Replace all filters periodically. For details, see the Operation and Maintenance Manual.
However, when working in severe conditions, it is necessary to consider replacing the filters at shorter intervals according to the oil and fuel (sulfur content) being used.
- Never try to clean the filters (cartridge type) and use them again. Always replace with new filters.
- When replacing oil filters, check if any metal particles are stuck to the old filter. If any metal particles are found, please contact your Komatsu distributor.
- Do not open packs of spare filters until just before they are to be used.
- Always use Komatsu genuine filters.

18.2 OUTLINE OF ELECTRIC SYSTEM

- If the wiring gets wet or the insulation is damaged, the electric system leaks and this could result in hazardous malfunction of the machine.
- Services relating to the electric system are (1) check of fan belt tension, (2) check of damage or wear in the fan belt and (3) check of battery fluid level.
- Never remove or disassemble any electric components installed in the machine.
- Never install any electric components other than those specified by Komatsu.
- Be careful to keep the electric system free of water when washing the machine or when it rains.
- When working on the seashore, carefully clean the electric system to prevent corrosion.
- The optional power source must never be connected to the fuse, starting switch, or battery relay.

19. WEAR PARTS LIST

Wear parts such as the filter element, air cleaner element, bolt on edge, etc. are to be replaced at the time of periodic maintenance or before their abrasion limits.

The wear parts should be changed correctly in order to use the machine economically.

For part change, Komatsu genuine parts of excellent quality should be used.

When ordering parts, please check the part number in the parts book.

The parts in parentheses are to be replaced at the same time.

Item	Part No.	Part Name	Q'ty	Replacement frequency
Engine oil filter	YM119005-35100	Oil filter assembly	1	Every 500 hours
Fuel filter (WA20)	YM119810-55650	Element	1	Every 500 hours
Fuel filter (WA30, 40, 50)	YM129100-55650	Element	1	Every 500 hours
Hydraulic filter (WA20)	361-60-11120	Cartridge	1	Every 1000 hours
Hydraulic filter (WA30, 40, 50)	363-60-35310	Cartridge	1	Every 1000 hours
HST oil filter	363-18-31470 (07000-02065)	Element (O-ring)	1 (1)	Every 1000 hours
Air cleaner (WA20)	YM129350-12900	Element	1	–
Air cleaner (WA30, 40, 50)	YM171058-12510	Element	1	–
Cutting edge (WA20, option)	361-815-2110 (02090-11045) (09218-11614)	Edge (Bolt) (Nut)	1 (6) (6)	–
Cutting edge (WA30)	362-972-1111 (02090-11050) (02205-11015) (01643-31645)	Edge (Bolt) (Nut) (Washer)	1 (6) (6) (6)	–
Cutting edge (WA40, 50)	363-70-21190 (02090-11050) (02205-11015) (01643-31645)	Edge (Bolt) (Nut) (Washer)	1 (7) (7) (7)	–

20. USE OF FUEL, COOLANT AND LUBRICANTS ACCORDING TO AMBIENT TEMPERATURE

PROPER SELECTION OF FUEL, COOLANT AND LUBRICANTS

RESERVOIR	KIND OF FLUID	AMBIENT TEMPERATURE										CAPACITY	
		-22 -30	-4 -20	14 -10	32 0	50 10	68 20	86 30	104 40	122 50	122°F	Specified	Refill
Engine oil pan	Engine oil						SAE30					WA20: 3.6 ℓ 0.95 US gal 0.68 UK gal WA30,40,50: 5.2 ℓ 1.37 US gal 1.14 UK gal	WA20: 3.1 ℓ 0.82 US gal 0.68 UK gal WA30,40,50: 4.7 ℓ 1.24 US gal 1.03 UK gal
		SAE10W											
		SAE10W-30											
		SAE15W-40											
Transfer case	Engine oil	SAE10W-30 or SAE10W										1.4 ℓ 0.37 US gal 0.31 UK gal	1.3 ℓ 0.34 US gal 0.29 UK gal
Hydraulic system	Engine oil											WA20: 22.0 ℓ 5.8 US gal 4.8 UK gal	WA20: 15.0 ℓ 4.0 US gal 3.3 UK gal
		SAE10W-30										WA30,40,50: 38.0 ℓ 10.0 US gal 8.4 UK gal	WA30,40,50: 28.0 ℓ 7.4 US gal 6.2 UK gal
Axle		See Note 1										WA20: 4.0 ℓ Front and rear 1.06 US gal 0.88 UK gal WA30,40,50: Front 4.8 ℓ 1.27 US gal 1.06 UK gal Rear 4.5 ℓ 1.19 US gal 0.99 UK gal	WA20: 4.0 ℓ Front and rear 1.06 US gal 0.88 UK gal WA30,40,50: Front 4.8 ℓ 1.27 US gal 1.06 UK gal Rear 4.5 ℓ 1.19 US gal 0.99 UK gal
Pins	Grease	NLGI No. 2										-	
Fuel tank	Diesel fuel						ASTM D975 No. 2					WA20: 25.0 ℓ 6.6 US gal 5.5 UK gal WA30,40,50: 42.0 ℓ 11.9 US gal 9.2 UK gal	-
		※											
Cooling system	Water	Add antifreeze										WA20: 4.2 ℓ 1.19 US gal 0.92 UK gal WA30: 5.5 ℓ 1.45 US gal 1.21 UK gal WA40,50: 5.8 ℓ 1.53 US gal 1.28 UK gal	-

※ ASTM D975 No. 1

When operating the machine at temperatures below -20°C, other equipment is needed, so please consult your Komatsu distributor.

Note 1:

For axle oil, use only recommended oil as follows.

- SHELL: DONAX TT or TD
- CALTEX: RPM TRACTOR HYDRAULIC FLUID
- CHEVRON: TRACTOR HYDRAULIC FLUID
- TEXACO: TDH OIL
- MOBIL: MOBILAND SUPER UNIVERSAL

It is possible to substitute engine oil CLASS-CD SAE30 for axle oil.

If noise comes from the brake, it is no problem of durability.

REMARK

- When fuel sulphur content is less than 0.5%, change oil in the oil pan every periodic maintenance hours described in this manual.
Change oil according to the following table if fuel sulphur content is above 0.5%.

Fuel sulphur content	Change interval of oil in engine oil pan
0.5 to 1.0%	1/2 of regular interval
Above 1.0%	1/4 of regular interval

- When starting the engine in an atmospheric temperature of lower than 0°C, be sure to use engine oil of SAE10W, SAE10W-30 and SAE15W-40, even though an atmospheric temperature goes up to 10°C more or less in the day time.
- Use API classification CD as engine oil and if API classification CC, reduce the engine oil change interval to half.
- There is no problem if single grade oil is mixed with multigrade oil (SAE10W-30, 15W-40), but be sure to add single grade oil that matches the temperature in the table.
- We recommend Komatsu genuine oil which has been specifically formulated and approved for use in engine and hydraulic work equipment applications.

Specified capacity: Total amount of oil including oil for components and oil in piping.

Refill capacity: Amount of oil needed to refill system during normal inspection and maintenance.

ASTM: American Society of Testing and Material

SAE: Society of Automotive Engineers

API: American Petroleum Institute

20. USE OF FUEL, COOLANT AND LUBRICANTS ACCORDING TO AMBIENT TEMPERATURE

No.	Supplier	Engine Oil [CD or CE] SAE10W, 30, 40 10W30, 15W40 (The 15W40 oil marked * is CE.)	Gear Oil [GL-4 or GL-5] SAE80, 90, 140	Grease [Lithium-Base] NLGI No. 2	Anti-freeze Coolant [Ethylene Glycol Base] Permanent Type
1	KOMATSU	EO10-CD EO30-CD EO10-30CD EO15-40CD	GO90 GO140	G2-LI G2-LI-S	AF-ACL AF-PTL AF-PT (Winter, one season type)
2	AGIP	Diesel sigma S Super dieselmulti- grade *Sigma turbo	Rotra MP	GR MU/EP	-
3	AMOCO	*Amoco 300	Multi-purpose gear oil	RYKON premium grease	-
4	ARCO	*Arcofleet S3 plus	Arco HD gear oil	Litholine HEP 2 Arco EP moly D	-
5	BP	Vanellus C3	Gear oil EP Hypogear EP	Energrease LS-EP2	Antifreeze
6	CALTEX	*RPM delo 400 RPM delo 450	Universal thuban Universal thuban EP	Marfak all purpose 2 Ultra-duty grease 2	AF engine coolant
7	CASTROL	*Turbomax *RX super CRD	EP EPX Hypoy Hypoy B Hypoy C	MS3 Spheerol EPL2	Anti-freeze
8	CHEVRON	*Delo 400	Universal gear	Ultra-duty grease 2	-
9	CONOCO	*Fleet motor oil	Universal gear lubricant	Super-sta grease	-
10	ELF	Multiperformance 3C Performance 3C	-	Tranself EP Tranself EP type 2	Glacelf
11	EXXON (ESSO)	Essolube D3 *Essolube XD-3 *Essolube XD-3 Extra *Esso heavy duty Exxon heavy duty	Gear oil GP Gear oil GX	Beacon EP2	All season coolant
12	GULF	Super duty motor oil *Super duty plus	Multi-purpose gear lubricant	Gulfcrown EP2 Gulfcrown EP special	Antifreeze and coolant
13	MOBIL	Delvac 1300 *Delvac super 10W-30, 15W-40	Mobilube GX Mobilube HD	Mobilux EP2 Mobilgrease 77 Mobilgrease special	-

20. USE OF FUEL, COOLANT AND LUBRICANTS ACCORDING TO AMBIENT TEMPERATURE

No.	Supplier	Engine Oil [CD or CE] SAE10W, 30, 40 10W30, 15W40 (The 15W40 oil marked * is CE.)	Gear Oil [GL-4 or GL-5] SAE80, 90, 140	Grease [Lithium-Base] NLGI No. 2	Anti-freeze Coolant [Ethylene Glycol Base] Permanent Type
14	PENNZOIL	*Supreme duty fleet motor oil	Multi-purpose 4092 Multi-purpose 4140	Multi-purpose white grease 705 707L White – bearing grease	Anti-freeze and summer coolant
15	PETROFINA	FINA kappa TD	FINA potonic N FINA potonic NE	FINA marson EPL2	FINA tamidor
16	SHELL	Rimula X	Spirax EP Spirax heavy duty	Alvania EP grease	–
17	SUN	–	Sunoco GL5 gear oil	Sunoco ultra prestige 2EP Sun prestige 742	Sunoco antifreeze and summer coolant
18	TEXACO	*Ursa super plus Ursa premium	Multigear	Multifak EP2 Starplex 2	Code 2055 startex antifreeze coolant
19	TOTAL	Rubia S *Rubia X	Total EP Total transmission TM	Multis EP2	Antigel/antifreeze
20	UNION	*Guardol	MP gear lube LS	Unoba EP	–
21	VEEDOL	*Turbostar *Diesel star MDC	Multigear Multigear B Multigear C	–	Antifreeze

21. STANDARD TIGHTENING TORQUES FOR BOLTS AND NUTS

21.1 INTRODUCTION OF NECESSARY TOOLS

The following tools are provided with the machine.

No.	Tool	Part No.	Remarks
1	Wrench	09002-01012	Applicable width across flats (S_1 - S_2) 10mm – 12mm,
2	Wrench	09002-01417	Applicable width across flats (S_1 - S_2) 14mm – 17mm
3	Wrench	09002-01922	Applicable width across flats (S_1 - S_2) 19mm – 22mm
4	Wrench	09002-02472	Applicable width across flats (S_1 - S_2) 24mm – 27mm
5	Screwdriver	09033-00190	Crosshead/flat head interchangeable type
6	Pliers	09036-00150	–
7	Grease pump (WA20, 30, 40)	21R-98-11110	For greasing work
	Grease pump (WA50)	07952-70004	
8	Grease cartridge (WA20, 30, 40)	21R-98-11120	(Lithium-base grease: 400 g)
	Grease cartridge (WA50)	07950-90403	

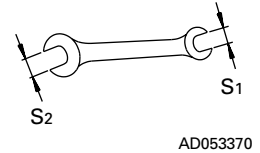

If any of the above tools are broken, please order them from your Komatsu distributor.

INSTALLATION OF GREASE PUMP (WA50 ONLY)

To install the grease pump to the holder on the floor surface, do as follows.

When installing the tools to the machine also, install between the holder, then fit the grease pump to the holder.

When doing this, be careful of the following.

1. Pull the grease pump chain to lock it.
(If the chain is not pulled, grease may ooze out.)

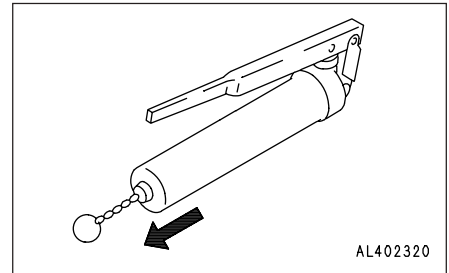

2. Fit a rubber band as shown in the diagram on the right to prevent the grease pump lever from moving.
3. To prevent the grease pump chain from vibrating and making noise, secure it with the pin as shown in the diagram on the right.

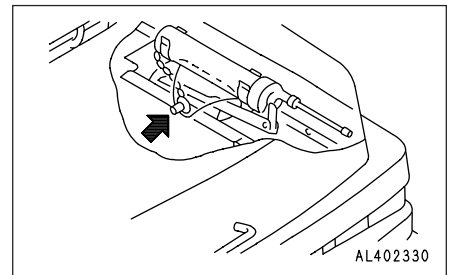

21.2 TORQUE LIST

Unless otherwise specified, tighten the metric bolts and nuts to the torque shown in the table.

The tightening torque is determined by the width across the flats (b) of the nut and bolt.

If it is necessary to replace any nut or bolt, always use a Komatsu genuine part of the same size as the part that was replaced.

Nm (newton meter): 1Nm \approx 0.1 kgm
 \approx 0.74 lbft

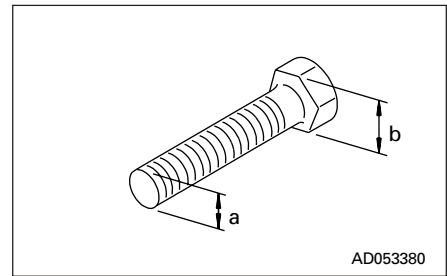

Thread diameter of bolt (mm) (a)	Width across flat (mm) (b)	AD054300		
		Nm	kgm	lbft
6	10	13.2 ± 1.4	1.35 ± 0.15	9.73 ± 1.03
8	13	31.4 ± 2.9	3.2 ± 0.3	23.2 ± 2.1
10	17	65.7 ± 6.8	6.7 ± 0.7	48.5 ± 5.0
12	19	112 ± 9.8	11.5 ± 1.0	82.6 ± 7.2
14	22	177 ± 19	18.0 ± 2.0	131 ± 14
16	24	279 ± 29	28.5 ± 3	206 ± 21
18	27	383 ± 39	39 ± 3	282 ± 29
20	30	549 ± 58	56 ± 6	405 ± 43
22	32	745 ± 78	76 ± 8	549 ± 58
24	36	927 ± 98	94.5 ± 10	684 ± 72
27	41	1320 ± 140	135 ± 15	973 ± 100
30	46	1720 ± 190	175 ± 20	1270 ± 140
33	50	2210 ± 240	225 ± 25	1630 ± 180
36	55	2750 ± 290	280 ± 30	2030 ± 210
39	60	3280 ± 340	335 ± 35	2420 ± 250

NOTICE

When tightening panels or other parts having tightening fixtures made of plastic, be careful not to use excessive tightening torque: doing so will damage the plastic parts.

22. PERIODIC REPLACEMENT OF SAFETY CRITICAL PARTS

To ensure safety at all times when operating or driving the machine, the user of the machine must always carry out periodic maintenance. In addition, to further improve safety, the user should also carry out periodic replacement of the parts given in the table. These parts are particularly closely connected to safety and fire prevention.

With these parts, the material changes as time passed, or they easily wear or deteriorate. However, it is difficult to judge the condition of the parts simply by periodic maintenance, so they should always be replaced after a fixed time has passed, regardless of their condition. This is necessary to ensure that they always maintain their function completely.

However, if these parts show any abnormality before the replacement interval has passed, they should be repaired or replaced immediately.

If the hose clamps show any deterioration, such as deformation or cracking, replace the clamps at the same as the hoses.

When replacing the hoses, always replace the O-rings, gaskets, and other such parts at the same time.

Ask your Komatsu distributor to replace the safety critical parts.

22. PERIODIC REPLACEMENT OF SAFETY CRITICAL PARTS

SAFETY CRITICAL PARTS (WA20)

No.	Safety critical parts for periodic replacement	Q'ty	Replacement interval
1	Fuel hose (fuel tank - feed pump)	1	Every 2 years or every 4000 hours, whichever comes first
2	Fuel hose (feed pump - fuel filter)	1	
3	Fuel hose (fuel filter - injection pump)	1	
4	Fuel return hose (injection pump - fuel filter)	1	
5	Fuel return hose (fuel filter - fuel tank)	2	
6	Fuel return hose (nozzle - injection pump)	1	
7	Fuel hose (between nozzle)	2	
8	Steering hose (pump - priority valve)	1	
9	Steering hose (orbitrol valve - steering cylinder)	2	
10	Steering cylinder packing, seal, O-ring	1	

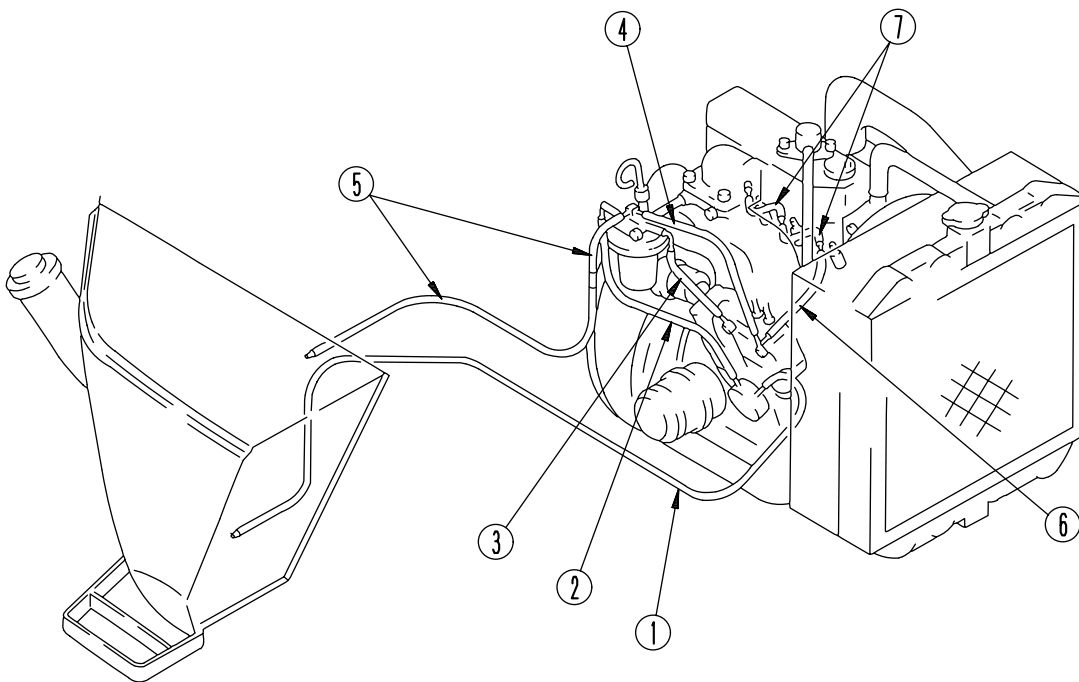

AL402340

22. PERIODIC REPLACEMENT OF SAFETY CRITICAL PARTS

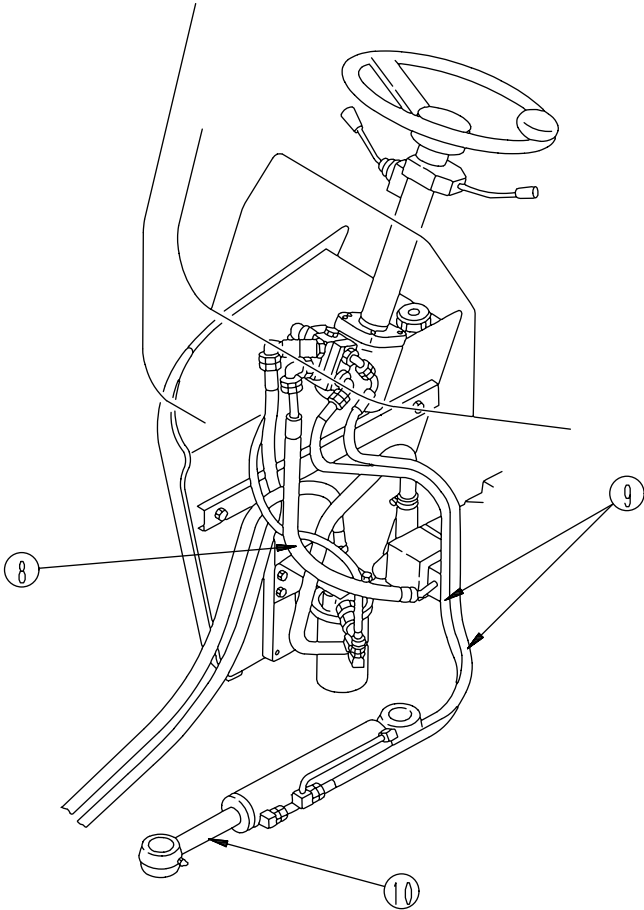

AL181080

22. PERIODIC REPLACEMENT OF SAFETY CRITICAL PARTS

SAFETY CRITICAL PARTS (WA30, WA50)

No.	Safety critical parts for periodic replacement	Q'ty	Replacement interval
1	Fuel hose (fuel tank - water separator)	1	Every 2 years or every 4000 hours, whichever comes first
2	Fuel hose (water separator - feed pump)	1	
3	Fuel hose (feed pump - fuel filter)	1	
4	Fuel hose (fuel filter - injection pump)	1	
5	Fuel return hose (injection pump - fuel filter)	1	
6	Fuel return hose (fuel filter - fuel tank)	2	
7	Fuel return hose (nozzle - injection pump)	1	
8	Fuel hose (between nozzle)	2	
9	Steering hose (pump - priority valve)	1	
10	Steering hose (orbitrol valve - steering cylinder)	3	
11	Steering cylinder packing, seal, O-ring	1	

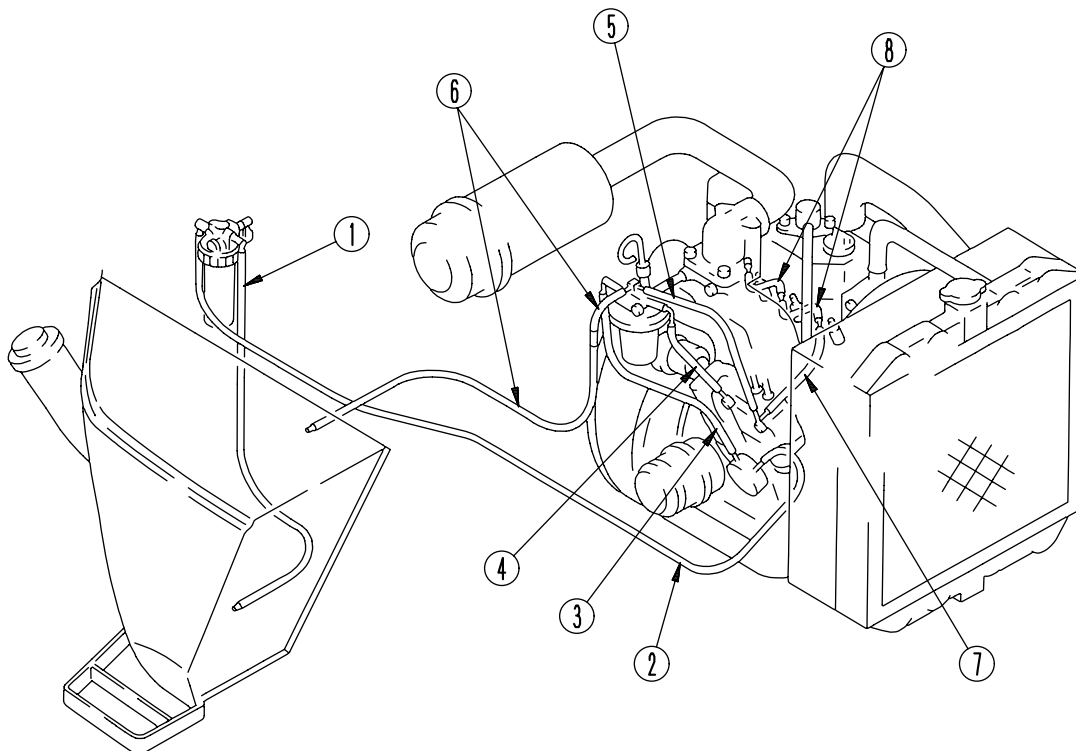

AL402350

22. PERIODIC REPLACEMENT OF SAFETY CRITICAL PARTS

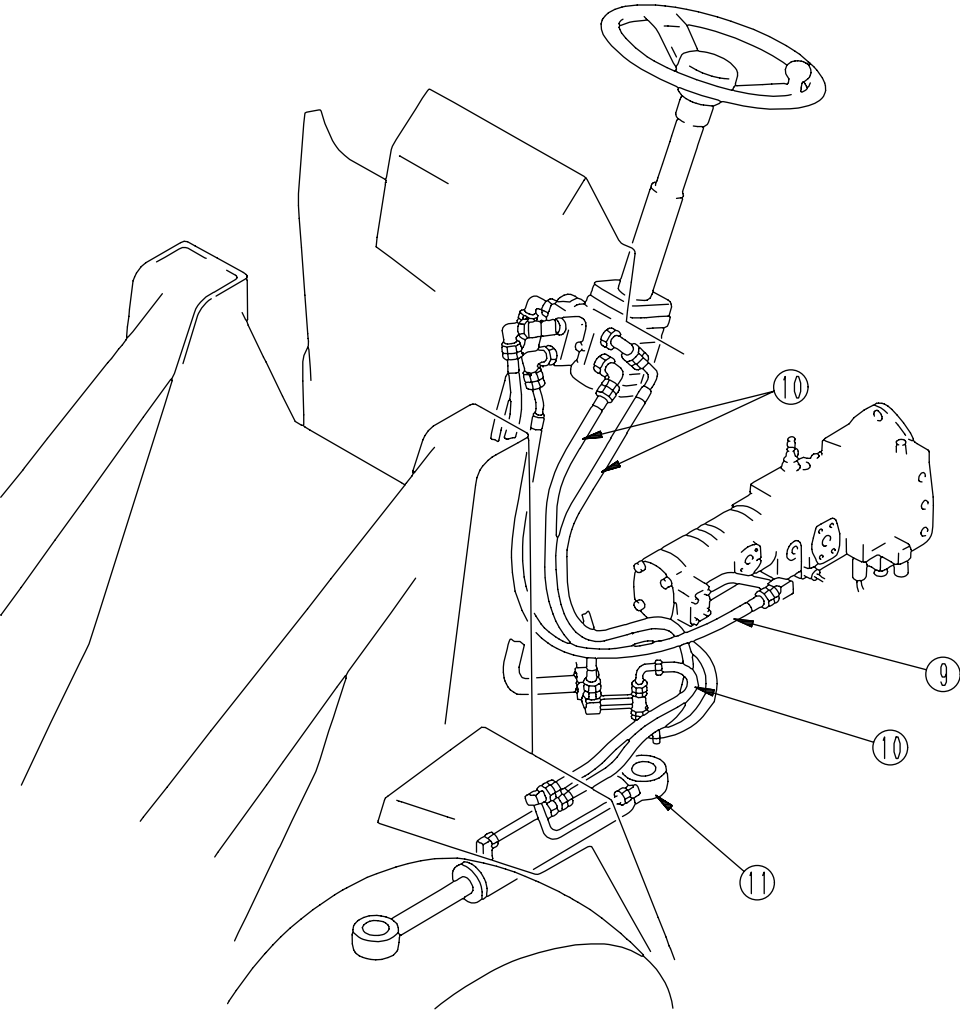

AL176030

SAFETY CRITICAL PARTS (WA40)

No.	Safety critical parts for periodic replacement	Q'ty	Replacement interval
1	Fuel hose (fuel tank - water separator)	1	Every 2 years or every 4000 hours, whichever comes first
2	Fuel hose (water separator - feed pump)	1	
3	Fuel hose (feed pump - fuel filter)	1	
4	Fuel hose (fuel filter - injection pump)	1	
5	Fuel return hose (injection pump - fuel filter)	1	
6	Fuel return hose (fuel filter - fuel tank)	2	
7	Fuel return hose (nozzle - injection pump)	1	
8	Fuel hose (between nozzle)	2	
9	Steering hose (pump - priority valve)	1	
10	Steering hose (orbitrol valve - steering cylinder)	2	
11	Steering cylinder packing, seal, O-ring	1	

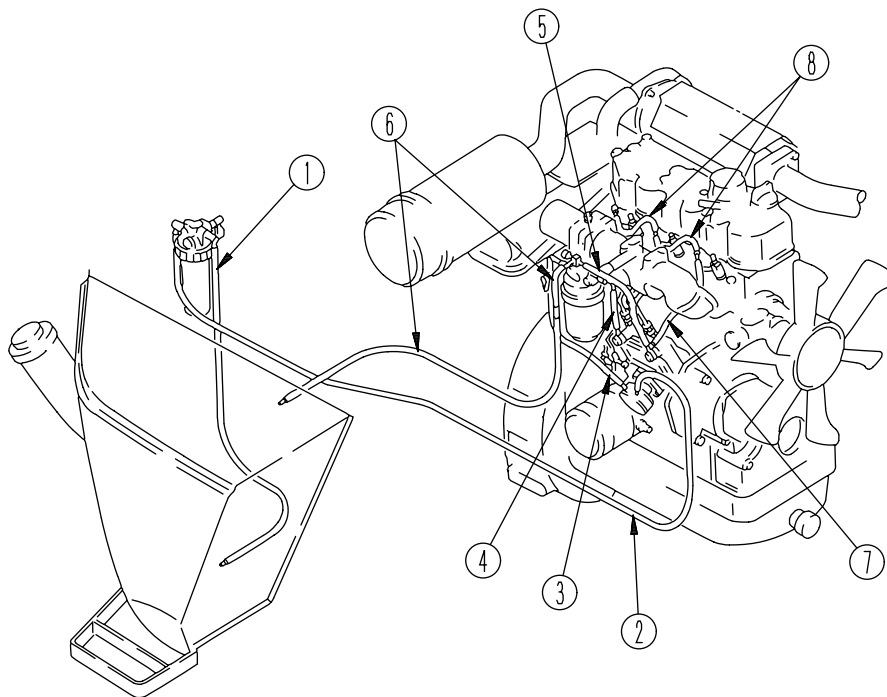

AL400190

22. PERIODIC REPLACEMENT OF SAFETY CRITICAL PARTS

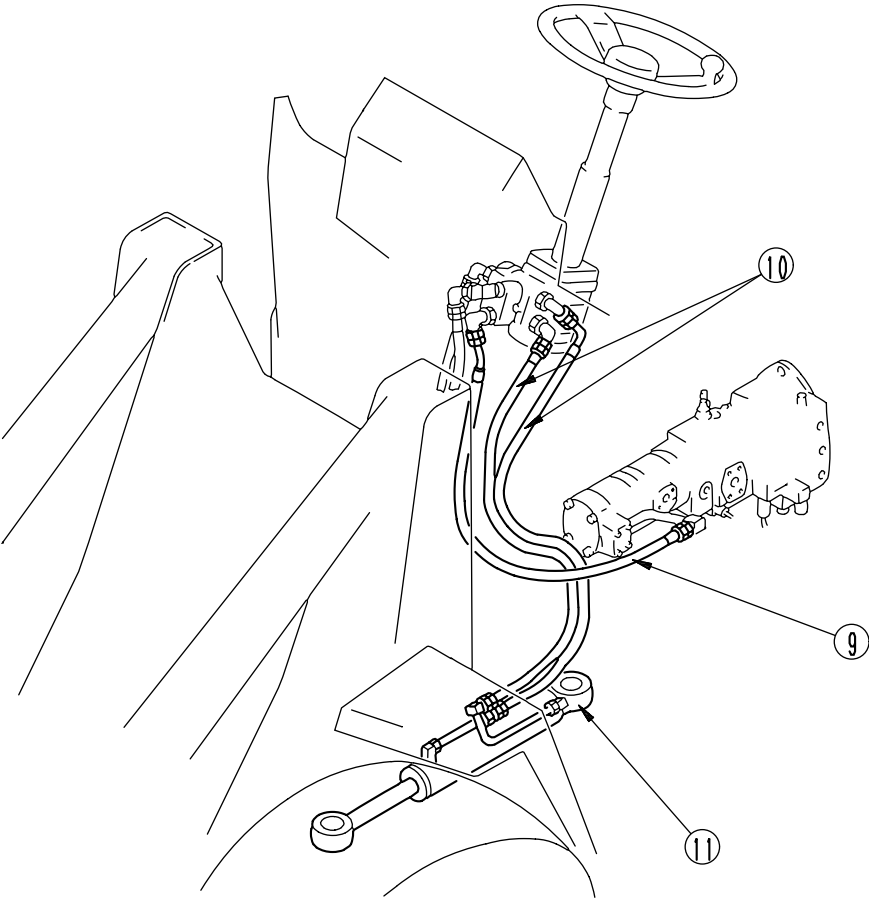

AL400200

23. MAINTENANCE SCHEDULE CHART

23.1 MAINTENANCE SCHEDULE CHART

SERVICE ITEM	PAGE
INITIAL 250 HOURS SERVICE (only after the first 250 hours)	
Change oil in engine oil pan, replace engine oil filter cartridge	3-27
Replace hydraulic tank filter element and HST filter element	3-27
Check engine valve clearance, adjust	3-27
WHEN REQUIRED	
Replace air cleaner element	3-28
Clean inside of cooling system	3-29
Drain water and sediment from fuel tank	3-33
Drain water from water separator (WA30, 40, 50)	3-33
Check transfer case oil level, add oil	3-34
Check axle oil level, add oil	3-35
Clean transfer case breather	3-36
Clean axle case breather	3-36
Clean radiator fin	3-37
Replace bolt-on cutting edge (option for WA20)	3-38
Adjust parking brake	3-39
Adjust parking brake release lever	3-40
Adjust brake pedal stroke	3-41
CHECK BEFORE STARTING	
Check bulb of pilot lamp	3-42
Check coolant level, add water	3-42
Check fuel level, add fuel	3-43
Check oil level in engine oil pan, add oil	3-44
Check parking brake alarm buzzer	3-45
Check effect of parking brake and the pedal stroke	3-45
Check travel of parking brake release lever	3-45
Check effect of brake and the pedal stroke	3-45
Check steering wheel play and operation of steering	3-45

SERVICE ITEM	PAGE
Check electric wiring	3-46
Check sound of horn	3-46
Check flashing of lamps, check for dirt or damage	3-47
Check engine exhaust color and sound	3-47
Check operation of gauges	3-47
Check direction of rear view mirror, check for dirt or damage	3-47
EVERY 50 HOURS SERVICE	
Check tire inflation pressure	3-48
Clean air cleaner dust cup	3-48
EVERY 250 HOURS SERVICE	
Lubricating	3-49
● Bucket link pin (2 points)	3-49
● Bucket pin (2 points)	3-49
● Tilt lever pin (1 point)	3-49
● Lift cylinder pin (4 points)	3-49
● Dump cylinder pin (2 points)	3-49
● Lift arm pivot pin (2 points)	3-49
● Steering cylinder pin (2 points)	3-49
Check oil level in hydraulic tank, add oil	3-50
Check and clean air cleaner element	3-51
Check tension of fan belt, adjust	3-52
Check battery electrolyte level	3-53
Check for loose wheel hub bolts, tighten	3-53
EVERY 500 HOURS SERVICE	
Replace fuel filter element	3-54
Change oil in engine oil pan, replace engine oil filter cartridge	3-55
Grease rear axle pivot pin (2 points)	3-56

SERVICE ITEM	PAGE
EVERY 1000 HOURS SERVICE	
Change oil in hydraulic tank, replace hydraulic oil filter cartridge and HST filter element	3-57
Lubricating	3-59
● Front drive shaft (3 points)	3-59
● Rear drive shaft (2 points)	3-59
● Center hinge pin (1 point)	3-59
EVERY 2000 HOURS SERVICE	
Change oil in transfer case	3-60
Change axle oil	3-61
Check alternator, starting motor	3-61
Check engine valve clearance, adjust	3-61

24. SERVICE PROCEDURE

24.1 INITIAL 250 HOURS SERVICE

Carry out the following maintenance only after the first 250 hours.

- **CHANGE OIL IN ENGINE OIL PAN, REPLACE ENGINE OIL FILTER CARTRIDGE**
- **REPLACE HYDRAULIC TANK FILTER ELEMENT AND HST FILTER ELEMENT**
- **CHECK ENGINE VALVE CLEARANCE, ADJUST**

For details of the method of replacing or maintaining, see the section on EVERY 500 HOURS, 1000 HOURS and 2000 HOURS SERVICE.

24.2 WHEN REQUIRED

24.2.1 REPLACE AIR CLEANER ELEMENT

⚠ WARNING

- Never clean or replace the air cleaner element with the engine running.
- When using pressure air to clean the element wear safety glasses or goggles to protect the eyes.

1. Loosen clip ① and remove dust cup ②.

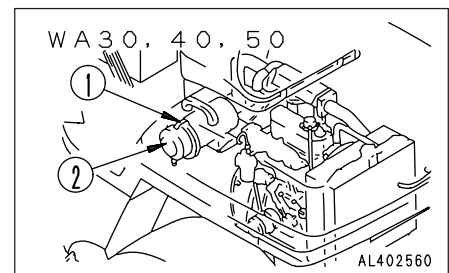
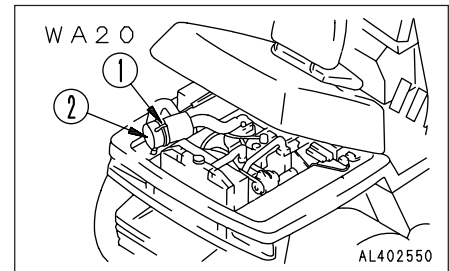

2. Loosen wing nut ③ and take out the element.
3. Blow with dry compressed air (max. 0.7 MPa (7 kgf/cm²)) to clean the inside of the case and the dust cup.
 - (1) Install a cover to the air intake after removing the element.
 - (2) When installing the element, be sure to assemble the seal washer.
 - (3) When installing the dust cup, install with the arrow mark on the dust cup pointing up.
 - (4) Replace the element if it has been cleaned six times or used for one year.
 - (5) Never remove the air cleaner element when the engine is running.
 - (6) If seal washer ④ is damaged or the thread of wing nut ③ is damaged, replace with new parts.
4. After cleaning, assemble the new element and install the dust cup.

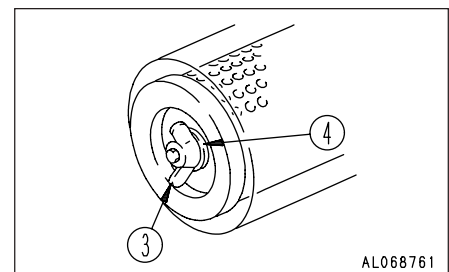

24.2.2 CLEAN INSIDE OF COOLING SYSTEM

⚠ WARNING

- **Soon after the engine has been stopped, the coolant is hot and can cause personal injury. Allow the engine to cool before draining water.**
- **Since cleaning is performed while the engine is running, it is very dangerous to go under the machine as the machine may suddenly start moving. While the engine is running, never go under the machine.**
- **Never remove the radiator cap when the engine is at operating temperature. At operating temperature, the coolant is under pressure. Boiling water and steam spurting out from the radiator could cause personal injury. Allow the engine to cool until the radiator filler cap is cool enough to touch with your hand. Remove the filler cap slowly to allow pressure to be relieved.**

- Stop the machine on level ground when cleaning or changing the coolant.
- Use a permanent type of antifreeze.
If, for some reason, it is impossible to use permanent type antifreeze, use an antifreeze containing ethylene glycol.
- In areas where the water is hard, always add Komatsu genuine corrosion resistor agent KI. One packet of corrosion resistor agent contains 100g. The standard density of the mixture should be 7g/l.
- Clean the inside of the cooling system, change the coolant and add the corrosion resistor agent KI according to the table below.

Kind of coolant	Cleaning inside of cooling system and changing coolant	Adding corrosion resistant KI
Permanent type antifreeze (All season type)	Every year (autumn) or every 2000 hours, whichever comes first	Every 1000 hours and when cleaning the inside of the cooling system and when changing coolant.
Non-permanent type antifreeze containing ethylene glycol (Winter, one season type)	Every 6 months (spring, autumn) (Drain antifreeze in spring, add antifreeze in autumn)	
When not using antifreeze	Every 6 months or every 1000 hours, whichever comes first	

- When deciding the ratio of antifreeze to water, check the lowest temperature in the past, and decide from the mixing rate table given below.

It is actually better to estimate a temperature about 10°C lower when deciding the mixing rate.

Mixing rate of water and antifreeze

WA20

Min. atmospheric temperature	°C	-5	-10	-15	-20	-25	-30
	°F	23	14	5	-4	-13	-22
Amount of antifreeze	ℓ	1.0	1.3	1.5	1.7	1.9	2.1
	US gal	0.27	0.36	0.43	0.49	0.55	0.60
	UK gal	0.21	0.28	0.33	0.38	0.42	0.46
Amount of water	ℓ	3.2	2.9	2.7	2.5	2.3	2.1
	US gal	0.92	0.83	0.76	0.70	0.64	0.59
	UK gal	0.71	0.64	0.59	0.54	0.50	0.46

WA30

Min. atmospheric temperature	°C	-5	-10	-15	-20	-25	-30
	°F	23	14	5	-4	-13	-22
Amount of antifreeze	ℓ	1.3	1.7	2.0	2.3	2.5	2.8
	US gal	0.33	0.44	0.52	0.60	0.67	0.73
	UK gal	0.28	0.36	0.44	0.50	0.56	0.61
Amount of water	ℓ	4.2	3.8	3.5	3.2	3.0	2.7
	US gal	1.12	1.01	0.93	0.85	0.78	0.72
	UK gal	0.93	0.85	0.77	0.71	0.65	0.60

WA40, 50

Min. atmospheric temperature	°C	-5	-10	-15	-20	-25	-30
	°F	23	14	5	-4	-13	-22
Amount of antifreeze	ℓ	1.4	1.8	2.1	2.4	2.7	2.9
	US gal	0.35	0.46	0.55	0.63	0.70	0.77
	UK gal	0.29	0.38	0.46	0.52	0.59	0.64
Amount of water	ℓ	4.4	4.0	3.7	3.4	3.1	2.9
	US gal	1.18	1.07	0.98	0.90	0.83	0.76
	UK gal	0.99	0.90	0.82	0.76	0.69	0.64

⚠ WARNING

Antifreeze is flammable, so keep it away from any flame.

- Use city water for the cooling water.
If river water, well water or other such water supply must be used, contact your Komatsu distributor.
- We recommend use of an antifreeze density gauge to control the mixing proportions.

1. Stop the engine and remove radiator cap ① slowly.
2. Prepare a container to catch the coolant, then open drain valve ② at the radiator left lower portion and drain plug ③ at the side of the cylinder block to drain the coolant.
3. After draining the water, close drain valve ② and plug ③, and fill with city water.
4. When the radiator is full of water, start the engine and run it at low idling.
Open drain valve ② and plug ③, run the engine at low idling, and flush water through the system for 10 minutes.
When doing this, adjust the speed of filling and draining the water so that the radiator is always full.
While flushing water through the system, watch carefully that the water inlet hose does not come out of the radiator water filler.
5. After flushing, stop the engine, open drain valve ② and plug ③, then close it again after all the water has drained out.
6. After draining the water, clean with a flushing agent.
For details of the cleaning method, see the instructions given with the cleaning agent.
7. After cleaning, open drain valve ② and plug ③ to drain all the cooling water, then close them and fill slowly with clean water.
8. When the water comes up to near the water filler port, open drain valve ② and plug ③, run the engine at low idling, and continue to run water through the system until clean colorless water comes out.

When doing this, adjust the speed of filling and draining the water so that the radiator is always full.
9. When the water is completely clean, stop the engine, close drain valve ② and plug ③.
10. Add cooling water until it overflows from the water filler.
11. To remove the air in the cooling water, run for 5 minutes at low idling, then for another five minutes at high idling.
When doing this, leave radiator cap off.
12. Drain the coolant inside sub-tank ④, then clean the inside of the sub-tank and fill again with water to a point between the FULL and LOW lines.
13. Stop the engine, wait for about 3 minutes, add cooling water up to near the radiator water filler port, then tighten the cap.

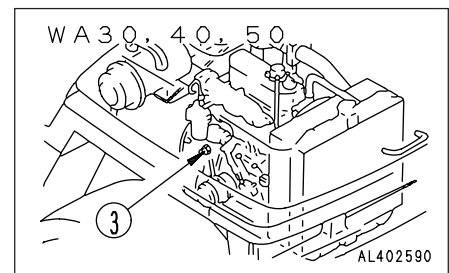
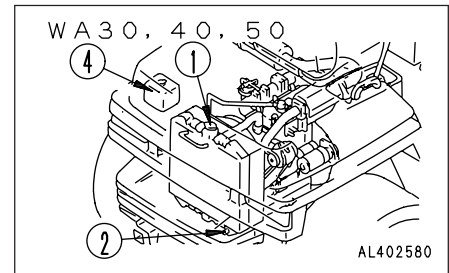
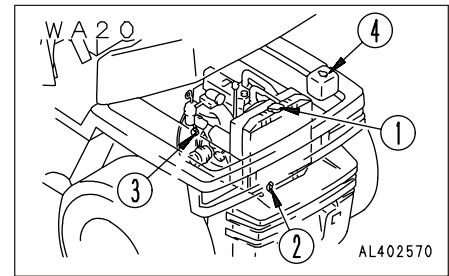

24.2.3 DRAIN WATER AND SEDIMENT FROM FUEL TANK

1. Drain before operate the machine.
2. Prepare a container to catch fuel.
3. Open drain valve ① at fuel tank lower portion, and then drain water and sediment. Be careful of coming down fuel.
4. Close drain valve ① after draining.

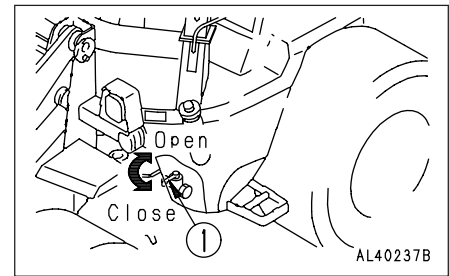
**24.2.4 DRAIN WATER FROM WATER SEPARATOR (WA30, 40, 50)**

Carry out this procedure if water separator caution pilot lamp lights on.

1. Turn lever ① up to close valve.
Turn the lever at least 90°.
2. Disconnect connector wiring to sensor, and remove ring nut ②, cup ③ and element ④.
3. Clean cup ③ and element ④ with diesel fuel or cleaning purpose oil.
4. After cleaning and assembling separator, turn lever ① down to open valve.
5. Open drain valve ⑤ at fuel tank lower portion, and then drain water and sediment.
6. After draining, mount connector wiring to sensor firmly.

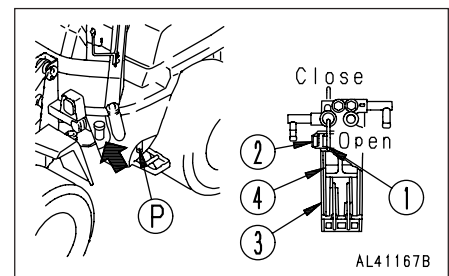

24.2.5 CHECK TRANSFER CASE OIL LEVEL, ADD OIL

⚠ WARNING

- When checking the oil level, apply the parking brake, and lock the front and rear frames with the safety bar and pin.
- The oil is at high temperature after the machine has been operated. Always wait for the temperature to go down before starting this operation.

Carry out this procedure if there is any oil leak from the transfer case.

1. Open filler plug \textcircled{F} and check the oil level.
If the level is correct, the oil comes out from hole.
2. If the oil level is not correct, add engine oil through oil filler \textcircled{F} .

For details of the oil to use, see "20. USE OF FUEL, COOLANT AND LUBRICANTS ACCORDING TO AMBIENT TEMPERATURE."

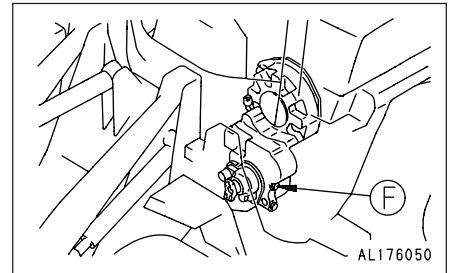

24.2.6 CHECK AXLE OIL LEVEL, ADD OIL

⚠ WARNING

- When checking the oil level, apply the parking brake, and lock the front and rear frames with the safety bar and pin.
- The oil is at high temperature after the machine has been operated. Always wait for the temperature to go down before starting this operation.

Carry out this procedure if there is any sign of oil on the axle case.

Carry out the inspection with the machine on a horizontal road surface. (If the road surface is at an angle, the oil level cannot be checked correctly.)

1. Stop the engine and remove oil level plug ①.
2. Wipe off any oil adhering to the oil level gauge ⑥ attached to plug ① with waste cloth.

3. Set the oil level gauge ⑥ as shown in the right diagram.
4. The oil level is correct when it is between the two lines provided on the oil level gauge. If the oil level does not reach the lower line, add axle oil through filler port ⑦.

For details of the oil to use, see "20. USE OF FUEL, COOLANT AND LUBRICANTS ACCORDING TO AMBIENT TEMPERATURE."

5. If the oil level is above the upper line, drain off the excess oil through drain plug ② and check the oil level again.
6. If the oil level is correct, install plug ①.

Tightening torque: $69 \pm 10 \text{ N}\cdot\text{m}$ ($7 \pm 1 \text{ kg}\cdot\text{m}$, $27 \pm 8 \text{ lbft}$)

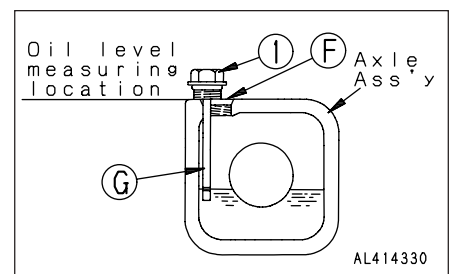
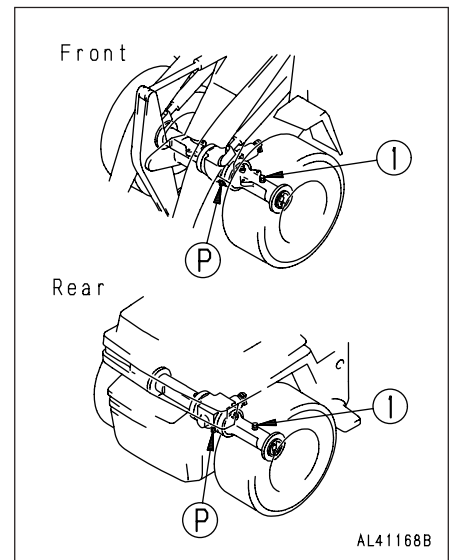

24.2.7 CLEAN TRANSFER CASE BREATHER

⚠ WARNING

When cleaning, apply the parking brake, and lock the front and rear frames with the safety bar and pin.

Remove all mud and dirt from around the breather with a brush.

1. Remove floor plate ① after removing the floor mat.
2. Remove breather ② after cleaning around the breather, and soak in the cleaning agent.

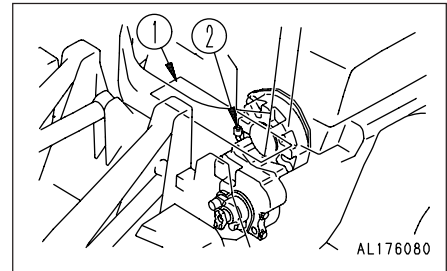

24.2.8 CHECK AXLE CASE BREATHER

⚠ WARNING

When cleaning, apply the parking brake, and lock the front and rear frames with the safety bar and pin.

Remove all mud and dirt from around the breather with a brush.

When cleaning the breather, clean the breathers at two places (front and rear).

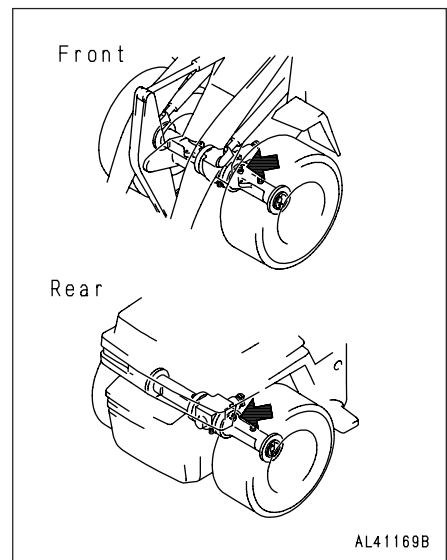

24.2.9 CLEAN RADIATOR FINS

Carry out this procedure if there is any mud or dirt seen stuck to the radiator.

1. Use compressed air to clean the mud dust, and leaves from the radiator fins. Steam or water may be used instead of compressed air.

When using steam, the radiator fins may be damaged if the steam nozzle is brought too close to the fins, so stand well away from the radiator.

2. The rubber hose should be checked at the same time. If the hose is found to have cracks or to be hardened by ageing, it should be replaced with a new one. Further, loosen hose clamps should also be tightened.

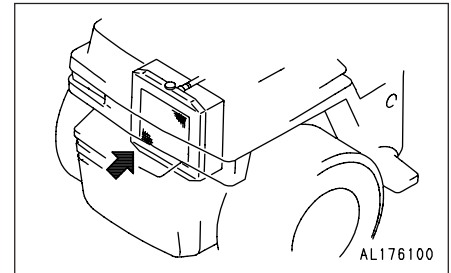

24.2.10 REPLACE BOLT-ON CUTTING EDGE (option for WA20)

⚠ WARNING

It is extremely dangerous if the work equipment moves when carrying out the turning or replacement operation. Set the work equipment in a stable position, stop the engine, then set the safety lock for the work equipment control lever securely to the LOCK position.

Turn or replace the cutting edge before the wear reaches the edge of the bucket.

1. Raise the bucket to a suitable height, then put blocks under the bucket to prevent the bucket from coming down. Raise the bucket so that the bottom surface of the bucket is horizontal.
2. Remove nuts ② and bolts ①, then remove cutting edge ③.
3. Clean the mounting surface of cutting edge ③.
4. Turn cutting edge ③ and install it to the bucket. When turning the edge, install it to the opposite side (left edge to right side, right edge to left side).

If both sides of the cutting edge are worn, replace with a new part.

If the wear extends to the mounting surface, repair the mounting surface before installing the cutting edge.

If bolt ① or nut ② are damaged, replace them at the same time.

5. Tighten nuts ② and bolts ① uniformly so that there is no gap between the bucket and cutting edge.

Tightening torque for mounting bolt: $265 \pm 29 \text{ N}\cdot\text{m}$

$(27 \pm 3 \text{ kgf}\cdot\text{m}, 54 \pm 6 \text{ lbft})$

6. Tighten the mounting bolts again after operating for several hours.

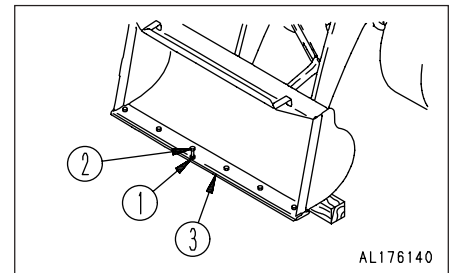

24.2.11 ADJUSTING PARKING BRAKE

Checking

The standard travel of the parking brake when it is depressed is 4 – 7 notches. If the travel is not within the standard range, adjust as follows.

Adjusting

WARNING

Before carrying out adjustment, always block the tires and take action to prevent the machine from slipping. Secure the front and rear frames with the safety bar and pin.

1. Pull the parking brake release lever to release the parking brake.
2. Remove the floor plate at the rear of the pedal.
3. Loosen locknuts ① and ②.

Locknut ① has a left-hand screw and locknut ② has a right-hand screw, so be careful of the direction of turning when loosening the locknuts.

4. When adjustment screw ③ is turned clockwise, rod ④ extends, and when it is turned counterclockwise, the rod retracts.
5. Adjust the length of rod ④ with adjustment screw ③ so that the travel at the tip of the pedal is 4 – 6 notches.

6. After completing the adjustment, tighten locknuts ① and ②.

Tightening torque: $17.2 \pm 2.5 \text{ N}\cdot\text{m}$ ($1.75 \pm 0.25 \text{ kgf}\cdot\text{m}$)

7. After adjusting, check the effect of the parking brake.

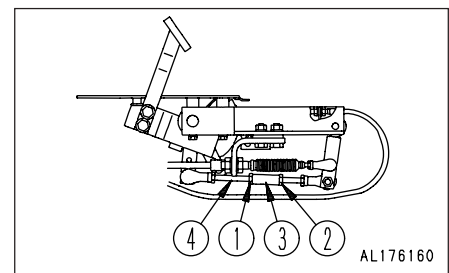
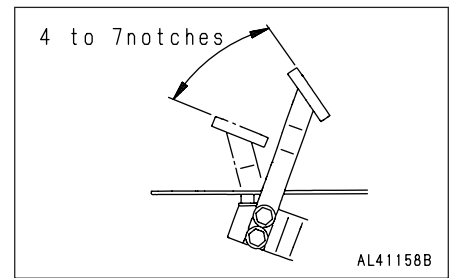

24.2.12 ADJUST PARKING BRAKE RELEASE LEVER

Checking

Depress the parking brake pedal 3 – 4 notches, then pull the release lever to return the parking brake pedal to its original position. If the travel is not 35 – 50 mm (1.4 – 2 in) when the lever is released, adjust as follows.

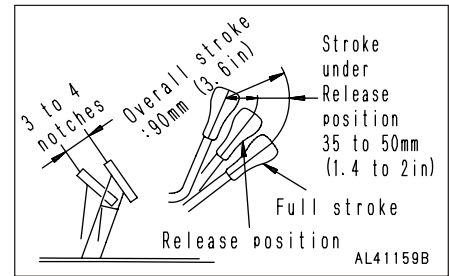

Adjusting

⚠ WARNING

**Before carrying out adjustment, always block the tires and take action to prevent the machine from slipping.
Secure the front and rear frames with the safety bar and pin.**

1. Loosen locknut ① of the cable.
2. Adjust the position of the cable so that the travel is 30 – 50 mm (1.2 – 2 in).
3. Secure with locknut ①.

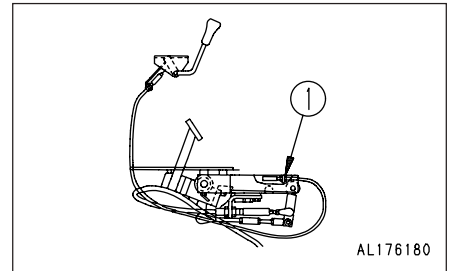

24.2.13 ADJUST BRAKE PEDAL STROKE

Checking

The travel at the tip of the pedal should be 60 – 85 mm (2.4 – 3.4 in). If the travel is not within the standard range, adjust as follows.

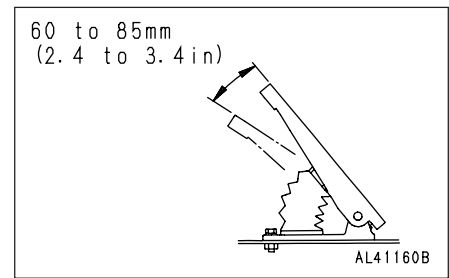

Adjusting

WARNING

Before carrying out adjustment, always block the tires and take action to prevent the machine from slipping. Secure the front and rear frames with the safety bar and pin.

1. Pull the parking brake release lever to release the parking brake.
2. Remove the floor plate at the rear of the pedal.
3. Loosen locknuts ① and ②.

Locknut ① has a left-hand screw and locknut ② has a right-hand screw, so be careful of the direction of turning when loosening the locknuts.

4. When adjustment screw ③ is turned clockwise, rod ④ extends, and when it is turned counterclockwise, the rod retracts.
5. Adjust the length of rod ④ with adjustment screw ③ so that the travel at the tip of the pedal is 60 – 85 mm (2.4 – 3.4 in).
6. After completing the adjustment, tighten locknuts ① and ②.

Tightening torque: $17.2 \pm 2.5 \text{ N}\cdot\text{m}$ ($1.75 \pm 0.25 \text{ kgf}\cdot\text{m}$, $3.5 \pm 0.5 \text{ lbft}$)

7. After adjusting, check the braking effect.

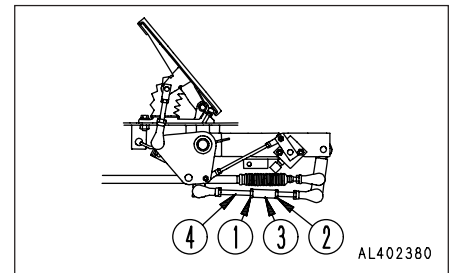

24.3 CHECK BEFORE STARTING

24.3.1 CHECK BULBS OF PILOT LAMPS

1. Turn the key in starting switch to the ON position.
2. When each pilot lamp ① lights on, bulbs are no problem.
3. When each lamp doesn't light, contact your Komatsu distributor for service.

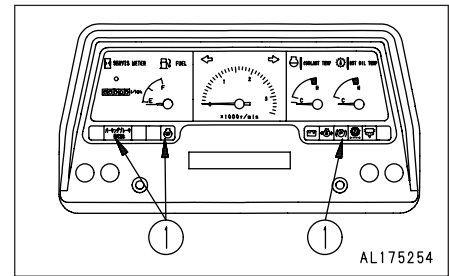

The preheating pilot lamp lights up only when the starting switch is at the HEAT position; the parking brake pilot lamp does not light up when the parking brake is not applied.

When the parking brake is released, the parking brake reminder caution lamp lights up and the alarm buzzer sounds.

24.3.2 CHECK COOLANT LEVEL, ADD WATER

⚠ WARNING

Normally, do not open the radiator cap. Always wait for the engine to cool down before checking the water level, and check using the sub-tank.

1. Open the engine side cover at the rear left side of the machine, and check that the coolant level is between the FULL and LOW marks on sub-tank ①. If the coolant level is low, add water to the FULL level through the water filler in sub-tank ①.
2. After adding water, tighten the cap securely.
3. If sub-tank ① is empty, check for water leakage, then add water to the radiator and sub-tank.

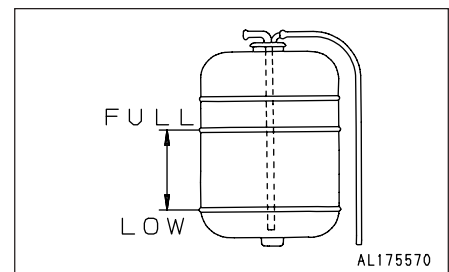
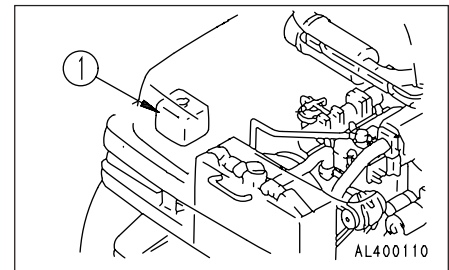

24.3.3 CHECK FUEL LEVEL, ADD FUEL

WARNING

When adding fuel, never let the fuel overflow. This may cause a fire. If spilling fuel, thoroughly clean up any spillage.

1. Turn the engine starting switch to the ON position, then check the fuel level with fuel gauge .

After checking, return the starting switch to the OFF position.

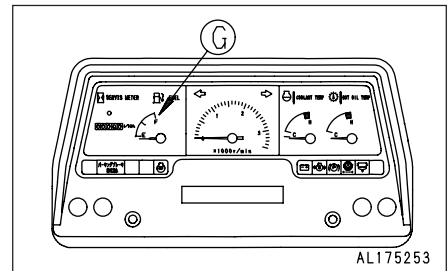

2. Upon completion of work, add fuel through filler  until the fuel tank is full.

For details of the method for opening and closing the cap, see "11.4 CAP WITH LOCK".

For details of the fuel to use, see "20. USE OF FUEL, COOLANT AND LUBRICANTS ACCORDING TO AMBIENT TEMPERATURE".

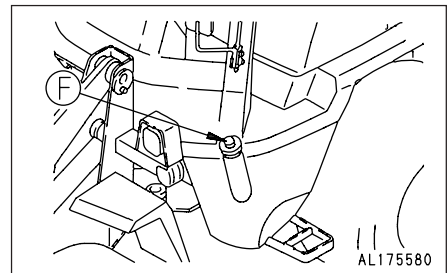

3. After adding fuel, tighten the cap securely.

Fuel capacity: WA20 25 ℓ (6.6 US gal, 5.5 UK gal)
 WA30, 40, 50 42 ℓ (11.9 US gal, 9.2 UK gal)

24.3.4 CHECK OIL LEVEL IN ENGINE OIL PAN, ADD OIL

1. Open the tilt hood at the rear of the machine.
2. Remove dipstick **G** and wipe the oil off with a cloth.
3. Insert dipstick **G** fully in the oil filler pipe, then take it out again.
4. The oil level should be between the H and L marks on dipstick **G**.
If the oil level is below the L mark, add engine oil through oil filler **F**.

For details of the oil to use, see "20. USE OF FUEL, COOLANT AND LUBRICANTS ACCORDING TO AMBIENT TEMPERATURE".

5. If the oil is above the H mark, drain the excess engine oil from drain plug **P**, and check the oil level again.
6. If oil level is correct, tighten the oil filler cap securely, then tighten the tilt hood.

REMARK

When checking the oil level after the engine has been operated, wait for at least 15 minutes after stopping the engine before checking.

If the machine is at an angle, make it horizontal before checking.

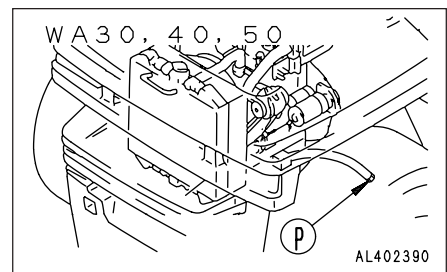
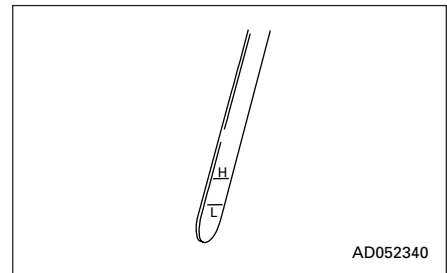
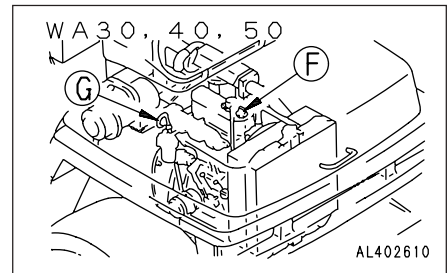
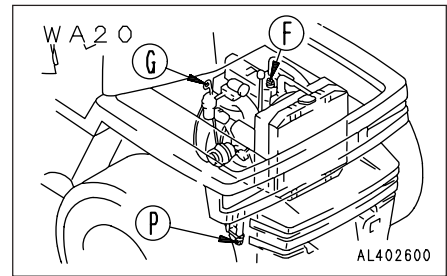

24.3.5 CHECK PARKING BRAKE ALARM BUZZER

Check that the alarm buzzer sounds when the engine is stopped with the parking brake not applied.

24.3.6 CHECK EFFECT OF PARKING BRAKE AND PEDAL STROKE

Depress the parking brake pedal and check that the parking brake pilot lamp lights up after 1 – 2 notches and that the parking brake pedal moves 4 – 7 notches when depressed fully.

If the above value is not correct, or if the braking effect is poor, see "24.2 WHEN REQUIRED".

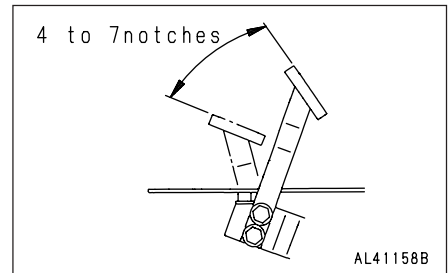

24.3.7 CHECK TRAVEL OF PARKING BRAKE RELEASE LEVER

Depress the parking brake pedal 3 – 4 clicks, then pull the release lever and check that the parking brake pedal returns to its original position.

The travel of the lever after the brake is released should be 35 – 50 mm (1.4 – 2 in).

If the above value is not correct, see "24.2 WHEN REQUIRED".

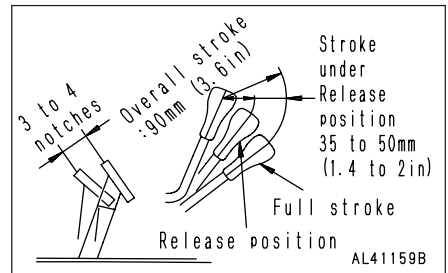

24.3.8 CHECK EFFECT OF BRAKE AND PEDAL STROKE

The travel at the tip of the pedal should be 60 – 85 mm (2.4 – 3.4 in).

If the travel is not within the standard range, or the braking effect is poor, see "24.2 WHEN REQUIRED".

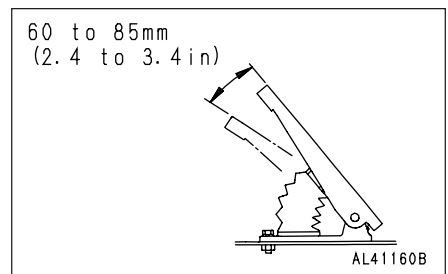

24.3.9 CHECK STEERING WHEEL PLAY AND OPERATION OF STEERING

The play at the outside circumference of the steering wheel should be 20 – 40 mm (0.8 – 1.6 in).

If it is more than 40 mm (1.6 in) or the operation of the steering is not smooth, please contact your Komatsu distributor for inspection.

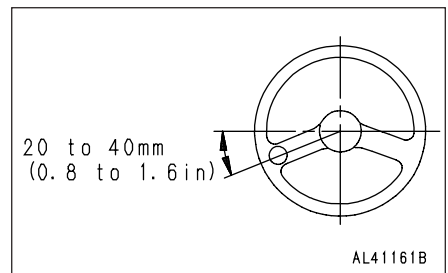

24.3.10 CHECK ELECTRIC WIRING

⚠ WARNING

- If fuses are frequently blown or if there are traces of short circuit on the electrical wiring, locate the cause and carry out repair.
- Accumulation of flammable material (dead leaves, twigs, grass, etc.) around the battery may cause fire, so always check and remove such material.
- Keep the top surface of the battery clean and check the breather hole in the battery cap. If it is clogged with dirt or dust, wash the battery cap to clear the breather hole.

Check for damage of the fuse and any sign of disconnection or short circuit in the electric wiring. Check also for loose terminals and tighten any loose parts.

Check the following points carefully.

- Battery
- Starting motor
- Alternator

When carrying out walk-around checks or checks before starting, always check if there is any accumulation of flammable material around the battery, and remove such flammable material.

Please contact your Komatsu distributor for investigation and correction of the cause.

24.3.11 CHECK SOUND OF HORN

1. Turn the starting switch ① to ON.
2. Check for sound of horn by pushing the horn switch ②.

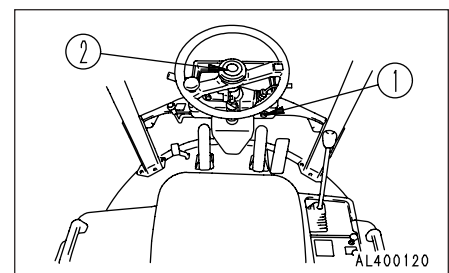

24.3.12 CHECK FLASHING OF LAMPS, CHECK FOR DIRT OR DAMAGE

Check for lamps lighting.

1. Turn the starting switch ① to ON.

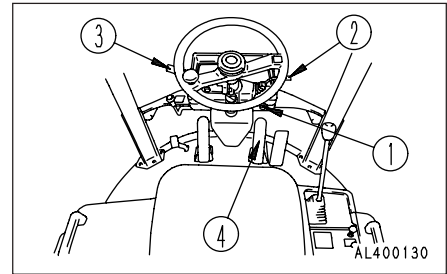

2. Check for the function of lamp switch ② at (A), (B) and (C) positions.

(A): OFF

(B): Tail lamps, panel box, side clearance lamps (option) and number plate lamps (option) light up.

(C): Head lamps light up in addition to lamps lighting up at position (B).

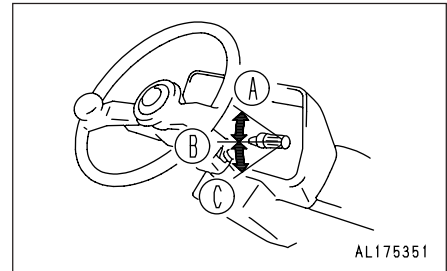

3. Check for lighting of the reverse lamps by positioning the directional lever ③ in REVERSE.

Check for sound of backup buzzer (option)

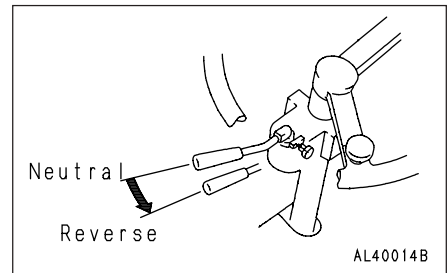

4. Check for lighting of brake lamps by depressing brake pedal ④.

Check for flashing of turn signal lamps.

1. Turn the starting switch ① to ON.

2. Check for function of turn signal lever ② at (A) and (B) positions.

(A): Left turn signal lamps (front and rear) flashes.

(B): Right turn signal lamps (front and rear) flashes.

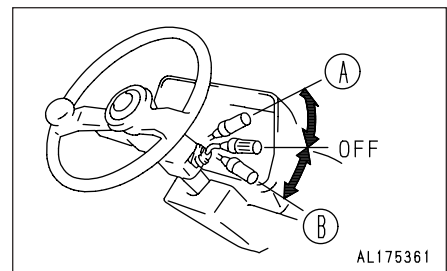

24.3.13 CHECK ENGINE EXHAUST COLOR AND SOUND

24.3.14 CHECK OPERATION OF GAUGES

24.3.15 CHECK DIRECTION OF REAR VIEW MIRROR, CHECK FOR DIRT OR DAMAGE

24.4 EVERY 50 HOURS SERVICE

24.4.1 CHECK TIRE INFLATION PRESSURE

Measure the inflation pressure before operations when the tires are cool.

Standard tire inflation pressure:

WA20, 40, 50	0.18 MPa (1.8 kgf/cm ²)
WA30	0.2 MPa (2.0 kgf/cm ²)

NOTICE

The appropriate tire inflation pressure differs according to the type of work, so see "12.17 HANDLING THE TIRES".

24.4.2 CLEAN AIR CLEANER DUST CUP

1. Remove clip ① and dust cup ②.
2. Throw out the dust inside the cup, then clean the inside. Install so that the arrow mark on the cup is at the top.

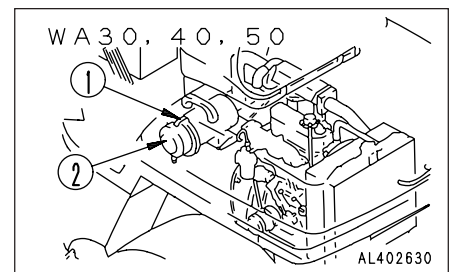
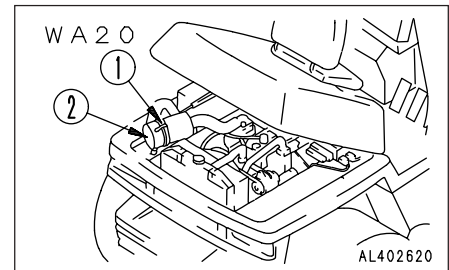

24.5 EVERY 250 HOURS SERVICE

Maintenance for every 50 hours service should be carried out at the same time.

24.5.1 LUBRICATING

⚠ WARNING

- Apply the parking brake, and lock the front and rear frames with the safety bar and pin.
- Set the work equipment in a stable condition, then stop the engine and apply the locks securely to the work equipment control lever.

1. Using a grease pump, pump in grease through the grease fittings marked by the arrows.
 2. After greasing, wipe off any old grease that is pushed out.
1. Bucket link pin (2 points)
 2. Bucket pin (2 points)
 3. Tilt lever pin (1 point)
 4. Lift cylinder pin (4 points)
 5. Dump cylinder pin (2 points)
 6. Lift arm pin (2 points)
 7. Steering cylinder pin (2 points)

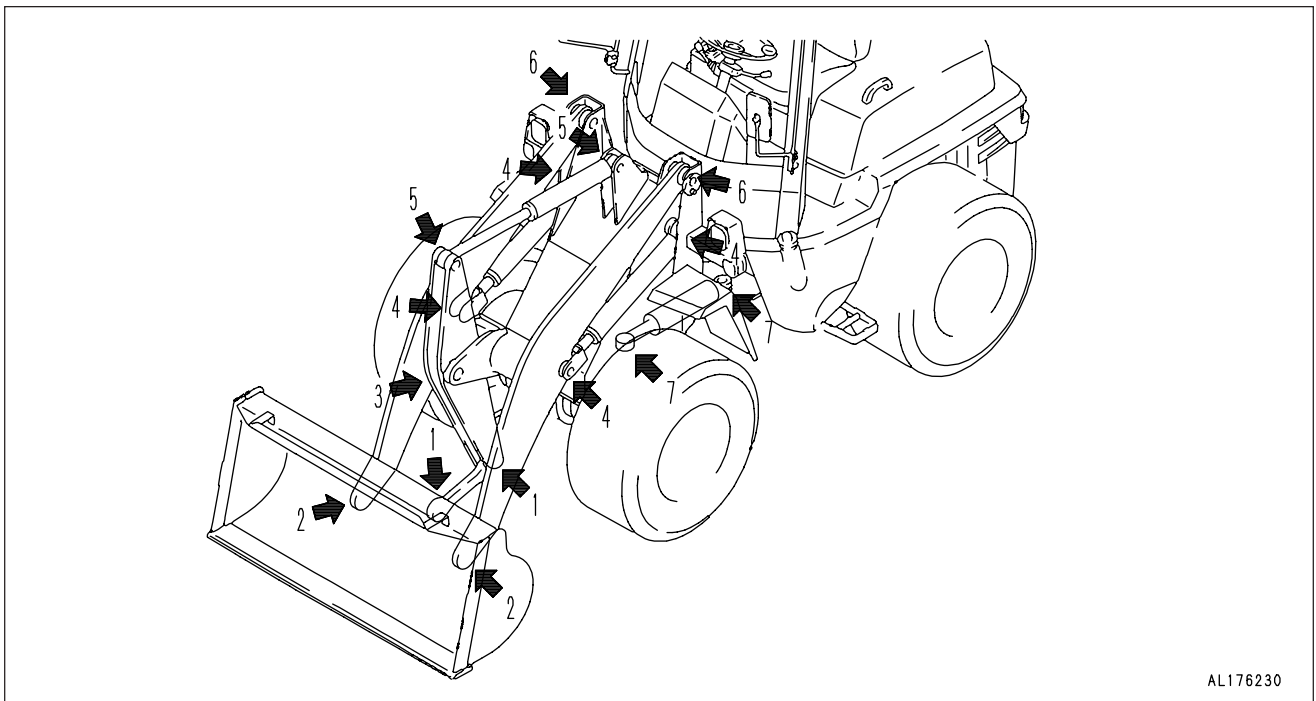

24.5.2 CHECK OIL LEVEL IN HYDRAULIC TANK, ADD OIL

⚠ WARNING

When the oil filler cap is removed, oil may spurt out, so stop the engine and wait for the oil temperature to go down, then turn the cap slowly to release the internal pressure before removing the cap.

1. Lower the bucket horizontally to the ground and stop the engine. Wait for 5 minutes, then check sight gauge **Ⓒ**.

NOTICE

When removing or installing the oil filler cap, use a tool which matches the width of the cap groove. It is dangerous to use a tool which does not match the groove width, because it will slip.

2. Add oil through oil filler port **Ⓕ**.

For details of the oil to use, see "20. USE OF FUEL, COOLANT AND LUBRICANTS ACCORDING TO AMBIENT TEMPERATURE".

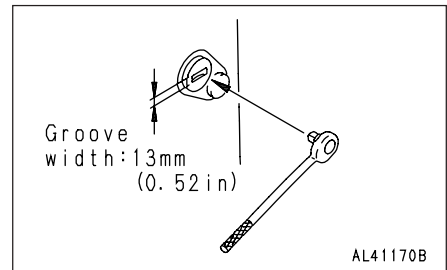
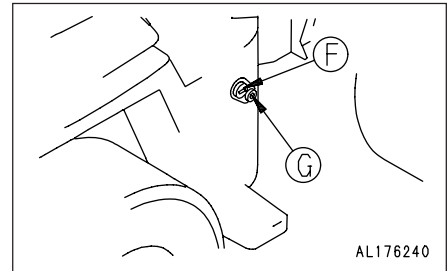

24.5.3 CHECK AND CLEAN AIR CLEANER ELEMENT

⚠ WARNING

- Never clean or replace the air cleaner element with the engine running.
- When using pressure air to clean the element wear safety glasses or goggles to protect the eyes.

Cleaning

1. Loosen clip ① and remove dust cup ②.

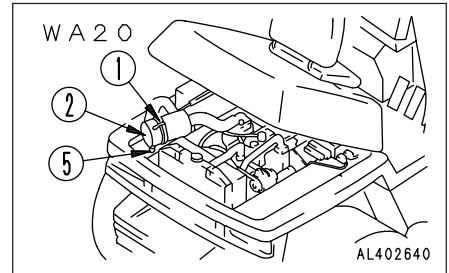

2. Loosen wing nut ③ and take out the element, then clean the element and dust cup ②.

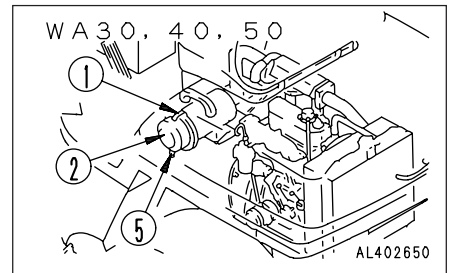

3. Blow with dry compressed air (max. 0.7 MPa (7 kgf/cm²)) from the inside of the element along its folds, then blow from the outside along the folds, and again from the inside.

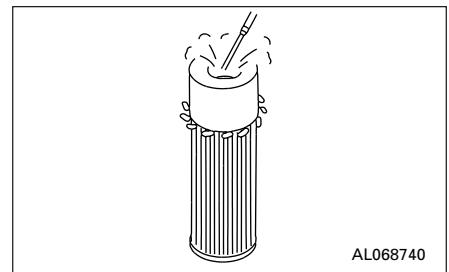

- (1) Install a cover to the air intake after removing the element.
- (2) When installing the element, be sure to assemble the seal washer.
- (3) When installing the dust cup, install with the arrow mark on the dust cup pointing up.
- (4) Replace the element if it has been cleaned six times or used for one year.
- (5) Never remove the air cleaner element when the engine is running.
- (6) If seal washer ④ is damaged or the thread of wing nut ③ is damaged, replace with new parts.
- (7) Remove evacuator valve ⑤ and clean with compressed air.

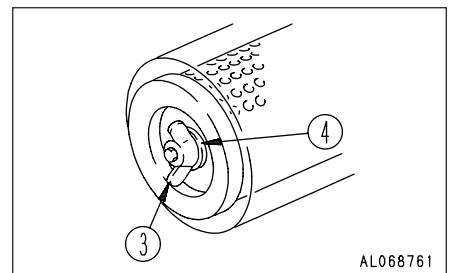

NOTICE

If small holes or thinner parts are found on element when it is checked with an electric bulb after cleaning and drying, replace the element.

When cleaning the element, do not hit it or beat it against anything.

Do not use element whose folds or gasket or seal are damaged.

4. After cleaning, assemble the new element and install the dust cup.

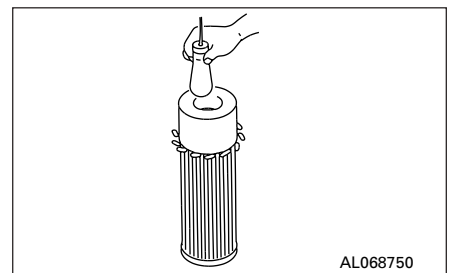

When carrying out this operation in a dusty place, clean the parts quickly.

24.5.4 CHECK TENSION OF FAN BELT, ADJUST CHECKING

The deflection of the belt should be approx. 10 to 15 mm (0.4 to 0.6 in) when pressed with a finger force of approx. 59 N (6 kgf) (13 lb) at a point midway between the fan pulley and the alternator pulley.

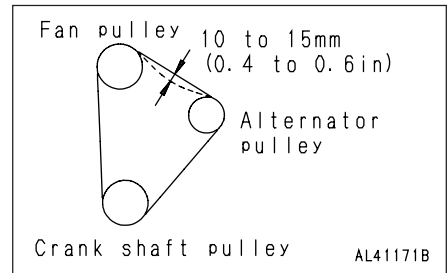
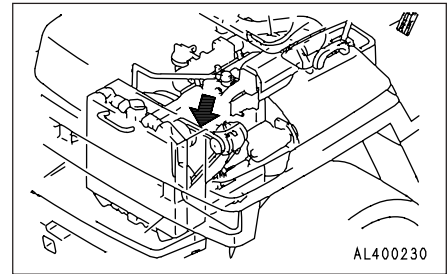

ADJUSTING

1. Loosen bolt ① and nut ②. And move alternator ③.
2. Check each pulley for damage, wear of the groove, and wear of the belt. In particular, be sure to check that the belt is not touching the bottom of the groove.
3. Replace the belt if it has stretched, leaving no allowance for adjustment, or if there is any cut or crack on belt.
4. When fixing, insert a piece of wood between the bar and alternator to prevent damage to the alternator.
5. When replacing the V-belt, adjust the tension again after operating for one hour.

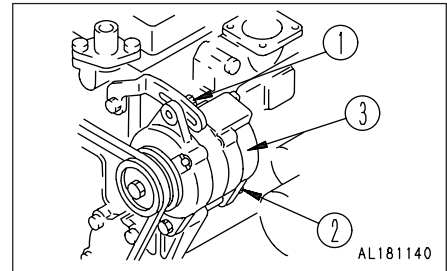

24.5.5 CHECK BATTERY ELECTROLYTE LEVEL

⚠ WARNING

- To avoid gas explosions, do not bring fire or sparks near the battery.
- Battery electrolyte is dangerous. If it gets in your eyes or on your skin, wash it off with large amounts of water, and consult a doctor.

Carry out this check before operating the machine.

1. Remove the cap, and check that the electrolyte is at UPPER level. If the electrolyte level is low, add distilled water to UPPER level. If the battery electrolyte is spilled, have dilute sulphuric acid added.
2. Clean the air hole in the battery cap, then tighten the cap securely.

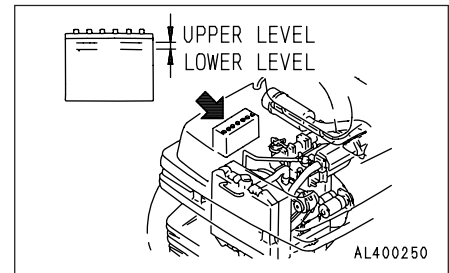

NOTICE

When adding distilled water in cold weather, add it before starting operations in the morning to prevent the electrolyte from freezing.

24.5.6 CHECK FOR LOOSE WHEEL HUB BOLTS, TIGHTEN

If wheel hub bolts ① are loose, tire wear will be increased and accidents may be caused.

1. Check for loose bolts, and tighten if necessary. When checking for loose bolts, always turn the bolts in the direction of tightening to check.

Tightening torque:

WA20	$168 \pm 1.5 \text{ N}\cdot\text{m}$ ($17 \pm 1.5 \text{ kgf}\cdot\text{m}$, $34 \pm 3 \text{ lbft}$)
WA30, 40, 50	$441 \pm 49 \text{ N}\cdot\text{m}$ ($45 \pm 5 \text{ kgf}\cdot\text{m}$, $90 \pm 10 \text{ lbft}$)

2. If any stud bolt is broken, replace all the stud bolts for that wheel.

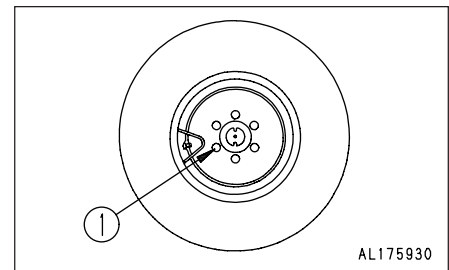

24.6 EVERY 500 HOURS SERVICE

Maintenance for every 50 and 250 hours should be carried out at the same time.

24.6.1 REPLACE FUEL FILTER ELEMENT

⚠ WARNING

- Engine is at high temperature immediately after the machine has been operated. Wait for engine to cool down before replacing the filter.
- Do not bring fire or sparks near the fuel.

Prepare a filter wrench and a container to catch the fuel.

1. Set the container to catch the fuel under the element cup.
2. Loosen ring ①, then remove element cup ② and the element.
3. Wash element cup ② in diesel oil or flushing oil, then install a new element.
When replacing the element, replace the O-ring also.
4. Fill with fuel, then turn the starting switch to the START position without depressing the accelerator pedal, and run the starting motor for 15 – 20 seconds to crank the engine and bleed the air from the system.
Do not run the starting motor continuously for more than 20 seconds. Wait for 2 minutes before turning the starting motor running it again.

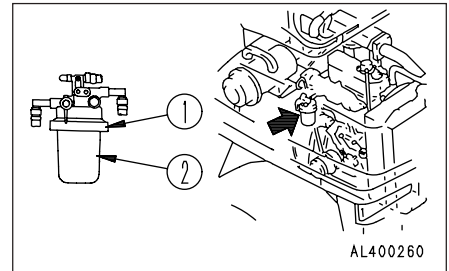

⚠ WARNING

When cranking the engine, confirm the safety around the engine, as the engine may start.

Use the same method when the engine has run out of fuel. Crank the engine 3 – 4 times for 15 – 20 seconds to bleed the air.

If the fuel tank is completely filled, the time taken to bleed the air can be reduced.

It is also possible to bleed the air manually by operating lever ③ of the feed pump up and down.

5. After replacing the filter element, start up the engine and check the filter seal face for possible oil leakage.

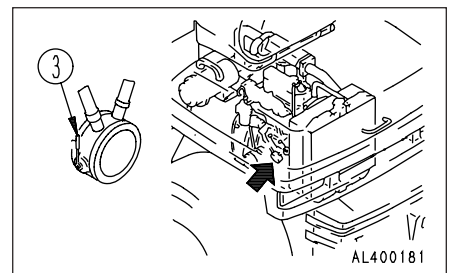

24.6.2 CHANGE OIL IN ENGINE OIL PAN, REPLACE ENGINE OIL FILTER CARTRIDGE

⚠ WARNING

The oil is at high temperature after the engine has been operated, so never change the oil immediately after finishing operations. Wait for the oil to cool down before changing it.

Prepare the following

- Container to catch drained oil:

WA20	Min. 3.1 l capacity
WA30, 40, 50	Min. 4.7 l capacity
- Refill capacity: WA20 3.1 l (0.82 US gal, 0.68 UK gal)
- WA30, 40, 50 4.7 l (1.24 US gal, 1.03 UK gal)
- Filter wrench

1. Open the tilt hood.
2. Open oil filler ⑥.
3. Place a container to catch the oil under drain plug ⑤.
4. Loosen drain plug ⑤, and drain the oil.
5. Check the drained oil, and if there are excessive metal particles or foreign material, please contact your Komatsu distributor.
6. Install drain plug ⑤.
7. Using the filter wrench, turn filter cartridge ① counterclockwise to remove it.
In particular, if this operation is carried out immediately after stopping the engine, a large amount of oil will come out, so wait for 10 minutes before starting the operation.
8. Clean the filter holder, then coat the seal and thread of the filter cartridge with engine oil (or coat thinly with grease) and install.

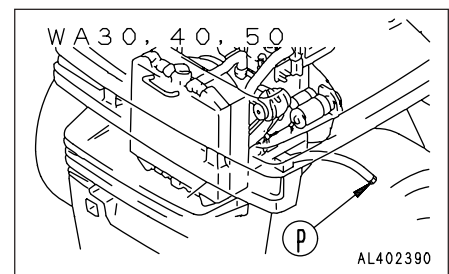
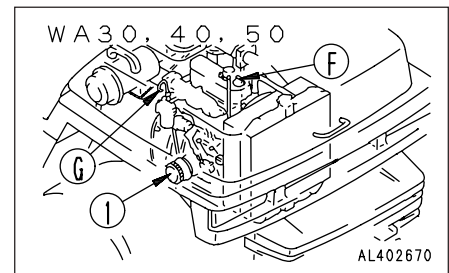
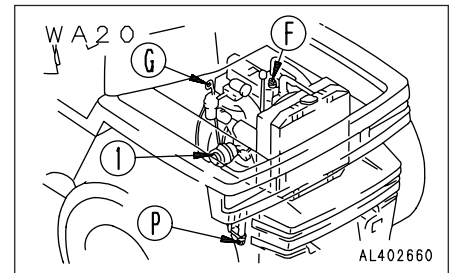

9. When installing, bring the seal surface into contact with the filter holder, then tighten a further 1/2 to 3/4 turns.
10. After replacing the filter cartridge, add engine oil through oil filler ⑤ until the oil level is between the H and L marks on the dipstick.

For details of the oil to use, see "20. USE OF FUEL, COOLANT AND LUBRICANTS ACCORDING TO AMBIENT TEMPERATURE".

11. Run the engine at idling for a short time, then stop the engine, and check that the oil level gauge ⑥ is between the H and L marks on the dipstick. For details, see "24.3 CHECK BEFORE STARTING".

Even if the machine has not been operated for 500 hours, the oil and filter cartridge must be replaced when the machine has been operated for 6 months.

In the same way, even if the machine has not been operated for 6 months, the oil and filter cartridge must be replaced when the machine has been operated for 500 hours.

Use API category CD class oil. If CC class oil must be used, change the oil and replace the oil filter at half the usual interval (250 hours).

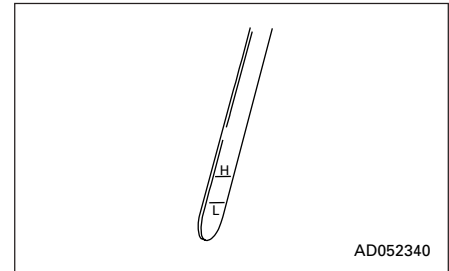

AD052340

24.6.3 GREASE REAR AXLE PIVOT PIN (2 POINTS)

⚠ WARNING

- Apply the parking brake, and lock the front and rear frames with the safety bar and pin.
- Set the work equipment in a stable condition, then stop the engine and apply the locks securely to the work equipment control levers.

1. Using a grease pump, pump in grease through the grease fittings marked by the arrows.
2. After greasing, wipe off any old grease that is pushed out.

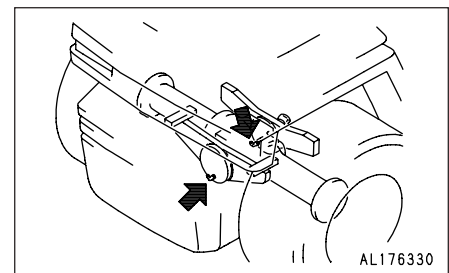

AL176330

24.7 EVERY 1000 HOURS SERVICE

Maintenance for every 50, 250 and 500 hours service should be carried out at the same time.

24.7.1 CHANGE OIL IN HYDRAULIC TANK, REPLACE HYDRAULIC OIL FILTER CARTRIDGE AND HST FILTER ELEMENT

⚠ WARNING

The oil is at high temperature immediately after the machine has been operated.
 Wait for the oil to cool down before changing the oil.
 When removing the oil filler cap, turn it slowly to release the internal pressure, then remove it carefully.

Prepare the following.

- Container to catch drained oil:

WA20	Min. 15 ℓ capacity
WA30, 40, 50	Min. 28 ℓ capacity
- Refill capacity:

WA20	15 ℓ (4.0 US gal, 3.3 UK gal)
WA30, 40, 50	28 ℓ (7.4 US gal, 6.2 UK gal)

1. Lower the bucket horizontally to the ground and apply the parking brake, then stop the engine.
2. When removing the oil filler cap ②, turn it slowly to release the internal pressure, then remove it carefully.
3. Set a container under drain plug ③ to catch the oil.
4. Remove drain plug ③ to drain oil.
5. After draining the oil, tighten drain plug ③.
6. Remove filter cartridge ① by turning with a wrench.
7. Clean the filter holder, fill the new filter cartridge with engine oil, then coat the packing of cartridge with engine oil or grease and install the cartridge.

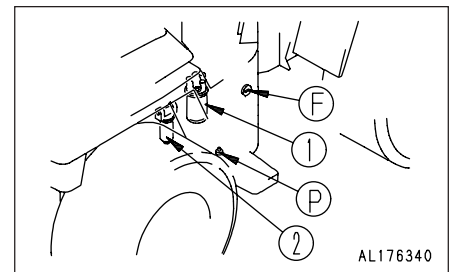

8. When installing, bring the parking surface into contact with the seal surface of the filter holder, then tighten $3/4 - 1$ turn.
9. Using a wrench, turn HST oil filter case ② to the left to remove it.
10. Install a new filter, then tighten the case.

NOTICE

When removing or installing the oil filler cap or drain plug, use a tool which matches the width of the cap groove. It is dangerous to use a tool which does not match the groove width, because it will slip.

11. Add engine oil through oil filler port ⑤ to the specified level.

For details of the oil to use, see "20. USE OF FUEL, COOLANT, AND LUBRICANTS ACCORDING TO AMBIENT TEMPERATURE".

12. Run the engine at low idling for 5 minutes to bleed the air from the HST circuit.
13. Check that the hydraulic oil is at the specified level. For details, see "24.5 EVERY 250 HOURS SERVICE".
14. Run the engine at low idling, then extend and retract the steering, bucket, and lift arm cylinders to a point approx. 100 mm (4 in) before the end of the stroke.

NOTICE

If the engine is run immediately at high speed or the cylinder is operated to the end of its stroke, there is danger that the air inside the cylinder will damage the piston packing.

15. Move the cylinders 3 to 4 times to the stroke end, and stop the engine. Remove the air from hydraulic tank by loosening the filler cap.
16. After adding oil, check that the oil is at the specified level. For details, see "24.5 EVERY 250 HOURS SERVICE".
17. After removing the air, install the filler cap.

If the HST oil filter clogging caution lamp lights up, replace the HST filter element immediately, even if 1000 hours or 1 year has not passed.

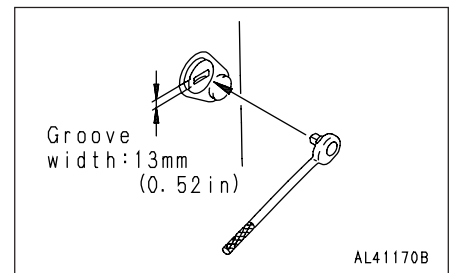

24.7.2 LUBRICATING

⚠ WARNING

- Apply the parking brake, and lock the front and rear frames with the safety bar and pin.
- Set the work equipment in a stable condition, then stop the engine and apply the locks securely to the work equipment control levers.

1. Using a grease pump, pump in grease through the grease fittings marked by the arrows.
2. After greasing, wipe off any old grease that is pushed out.

1. Front drive shaft (3 points)
2. Rear drive shaft (2 points)
3. Center hinge pin (1 point)

REMARK

Grease to the shafts and pin until the grease goes up from seal portion.

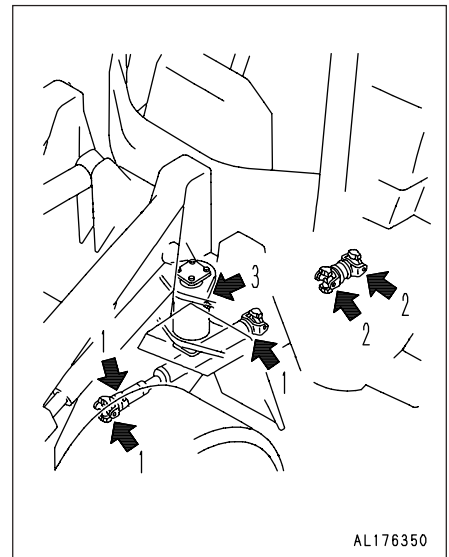

24.8 EVERY 2000 HOURS SERVICE

Maintenance for every 50, 250, 500 and 1000 hours service should be carried out at the same time.

24.8.1 CHANGE OIL IN TRANSFER CASE

⚠ WARNING

The oil is at high temperature after the machine has been operated. Always wait for the temperature to go down before starting this operation.

Prepare the following.

- Container to catch drained oil: Min. 1.3 ℓ capacity
- Refill capacity: 1.3 ℓ (0.33 US gal, 0.28 UK gal)

1. Set a container under drain plug \textcircled{P} to catch the oil, then remove drain plug \textcircled{P} and drain the oil. Be careful not to get the oil over yourself.
Loosen drain plug \textcircled{P} gradually to prevent the oil from suddenly spurting out, then remove it slowly.

2. After draining the oil, tighten drain plug \textcircled{P} .

Tightening torque: $59 \pm 10 \text{ N}\cdot\text{m}$ ($6 \pm 1 \text{ kgf}\cdot\text{m}$)

3. Add engine oil through oil filler port \textcircled{F} to the specified level.

For details of the oil to use, see "20. USE OF FUEL, COOLANT, AND LUBRICANTS ACCORDING TO AMBIENT TEMPERATURE".

4. After adding oil, check that the oil is at the specified level. For details, see "24.2 WHEN REQUIRED".
5. Check that there is no leakage of oil from the transfer case.

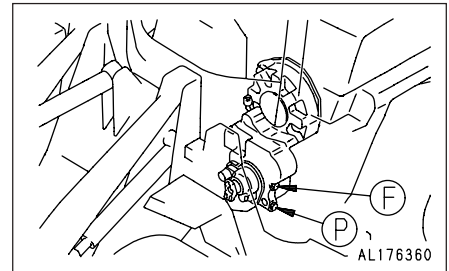

24.8.2 CHANGE AXLE OIL

⚠ WARNING

The oil is at high temperature after the machine has been operated. Always wait for the temperature to go down before starting this operation.

Prepare the following.

- Container to catch drained oil:
 - WA20 Min. 8.0 l capacity
 - WA30, 40, 50 Min. 9.3 l capacity
 - Refill capacity:

WA20 (front and rear, each)	4.0 l (1.06 US gal, 0.88 UK gal)
WA30, 40, 50 (front)	4.8 l (1.27 US gal, 1.06 UK gal)
(rear)	4.5 l (1.19 US gal, 0.99 UK gal)
1. Set a container to catch the oil under drain plug (P).
 2. Remove front and rear oil filler plugs (1), then remove drain plug (P) to drain the oil.
 3. After draining the oil, clean drain plug (P), then install it.
 4. Add axle oil through plug hole (1) at the specified level.

For details of the oil to use, see “20. USE OF FUEL, COOLANT AND LUBRICANTS ACCORDING TO AMBIENT TEMPERATURE”.

5. After adding oil, check that the oil is at the specified level. For details, see “24.2 WHEN REQUIRED”.

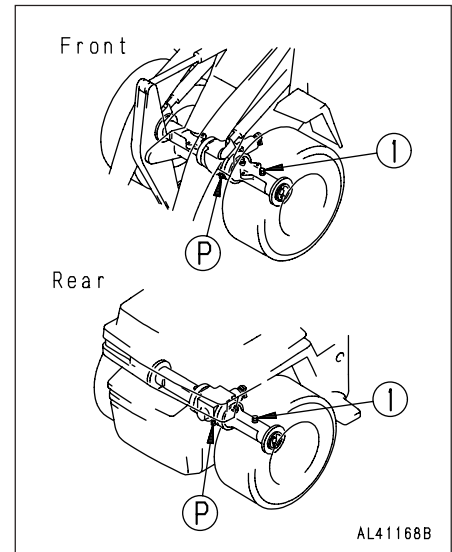

24.8.3 CHECK ALTERNATOR, STARTING MOTOR

The brush may be worn, or the bearing may have run out of grease, so contact your Komatsu distributor for inspection or repair.

If the engine is started frequently, carry out inspection every 1000 hours.

24.8.4 CHECK ENGINE VALVE CLEARANCE, ADJUST

As special tool is required for removing and adjusting the parts, request your Komatsu distributor for service.

MEMO

SPECIFICATIONS

25. SPECIFICATIONS

WA20-2

PERFORMANCE

● Bucket capacity		0.28 m ³
● Normal load		4.4 kN (450 kgf)
● Travel speed	Forward	15.0 km/h
	Reverse	15.0 km/h
● Max. rimpull		16.7 kN (1,700 kgf)
● Min. turning radius	Outside of chassis	2,540 mm
	Center of outside tire	2,950 mm

WEIGHT

● Operating weight	Including 1 operator (55 kg, 110 lb) and a canopy	1,735 kg (3,470 lb)
	Including 1 operator (55 kg, 110 lb) and a cab	1,885 kg (3,770 lb)

ENGINE

● Model	Komatsu 3D78AE-3A diesel engine
● Flywheel horsepower	16.2 kW/2,600 rpm
● Max. torque	73.5 N•m/1,500rpm (7.5 kgf•m/1,500 rpm)
● Starting motor	12 V 1.8 kW
● Alternator	12 V 40 A
● Battery	12 V 60 Ah x 1 piece

OPTIONS, ATTACHMENTS

26. OPTIONAL PARTS AND ATTACHMENTS

Name	Specifications, use				
		WA20-2	WA30-5	WA40-3	WA50-3
Large bucket	Loading and transporting the snow	○ (0.4 m ³)	○ (0.5 m ³)	○ (0.6 m ³)	○ (0.8 m ³)
Ranch bucket	Loading and transporting at ranch	○	○ (0.65 m ³)	○ (0.8 m ³)	○
Bolt-on cutting edge		○	○ (STD)	○ (STD)	○ (STD)
Dumping fork	Loading and transporting small-diameter lumber	○	○	○	○
Lumber fork	Loading and transporting small-diameter lumber	○	○	○	○
Multi coupler	Easy installation and removing for other work equipment	○	○	○	○
Steel cab		○	○	○	○
Heater	Heating operator's cab	○	○	○	○

○ : Available in the future

The other attachments are also available, so please contact your Komatsu distributor.

27. SEAT BELT

Always install a seat belt on machines equipped with ROPS.

WARNING

- Before fitting the seat belt, check that there is no abnormality in the mounting bracket and mounting belt of the belt. If the belt is worn or damaged, replace it.
- Always fasten the seat belt before starting operations.
- Always use the seat belt during operations.
- Do not twist the left or right side of the seat belt when fastening it.

27.1 FASTENING AND REMOVING BELT

Fasten the belt so that it is tight without being too tight.

1. Sit on the seat, depress the brake pedal fully, and adjust the seat so that your back is pressed against the backrest.
2. After adjusting the seat position, adjust teaser belt ①. Tense the teaser belt and install it when there is no one sitting on the seat. (Machine equipped with suspension seat)
3. Sit on the seat, take buckle ② and tongue in your left and right hands, insert tongue into buckle ②, and pull the belt to check that it is securely locked.
4. When removing the belt, raise the lever of buckle ② to free the belt.

Adjust the length of the buckle and tongue so that the belt follows your body without twisting, and adjust so that the buckle is in the middle at the front of your body.

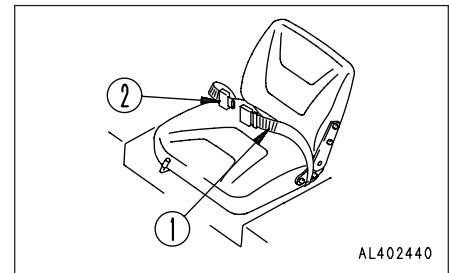

27.2 ADJUST BELT LENGTH

TO MAKE BELT SHORTER

Pull the free end of the belt at the buckle end or tongue end.

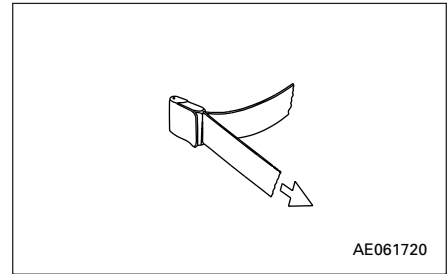

TO MAKE BELT LONGER

Set the belt holding the buckle or tongue end at right angles to the buckle or tongue, and pull.

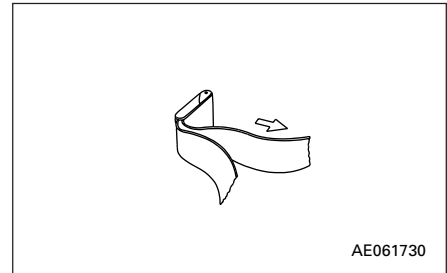

27.3 CHECK SEAT BELT AND MOUNTS

Check that the bolts for the seat belt mounts on the machine are not loose. Tighten any loose bolts.

Tightening torque: $24.5 \pm 5 \text{ N}\cdot\text{m}$ ($2.5 \pm 0.5 \text{ kgf}\cdot\text{m}$)

If the belt is damaged or frayed, or the mounting clamps are damaged or deformed, replace the seat belt.

28. EQUIPMENT WITH CAB

28.1 SWITCHES

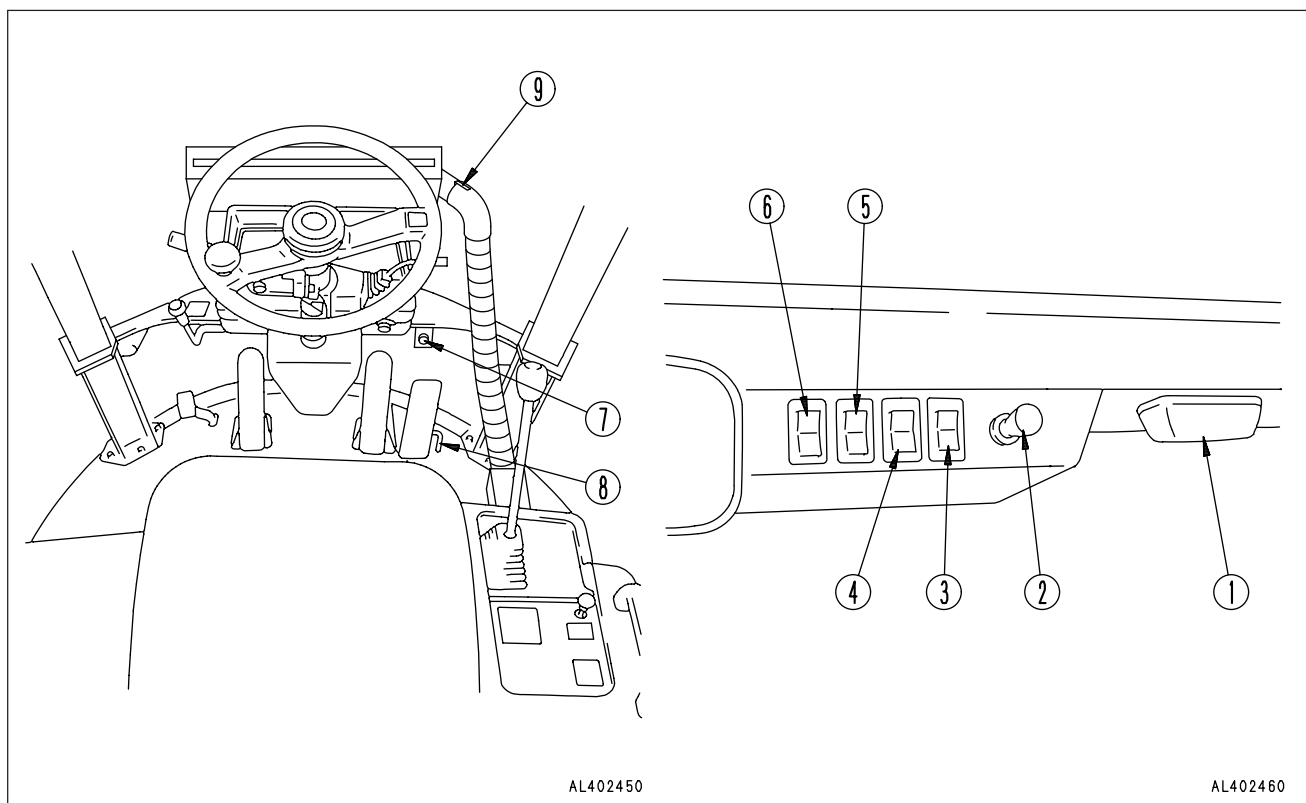

1. ROOM LAMP SWITCH

ON: Lights up
OFF: Goes off

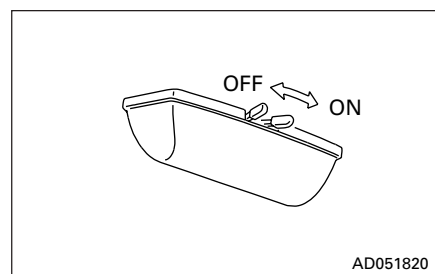

2. FRONT WIPER SWITCH

This switch operates the front wiper.

It also acts as the window washer switch.

Operate the switch as follows.

- Window washer only
Turn the switch to the right to spray out water.

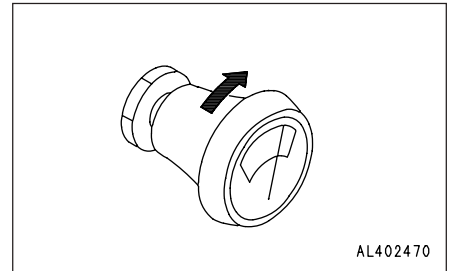

- Wiper only
Pull the switch out to operate the wiper.
Position ①: OFF
Position ②: Wiper operates at low speed
Position ③: Wiper operates at high speed

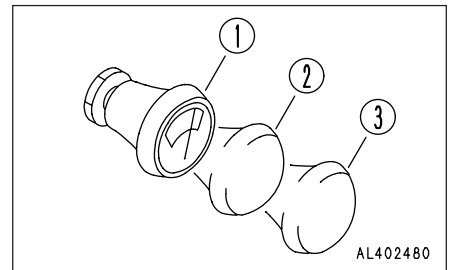

- Wiper and window washer
Pull the switch out to the operating position for the wiper, then turn the switch to the right to spray out water.

Be careful of the following when using the wiper and washer.

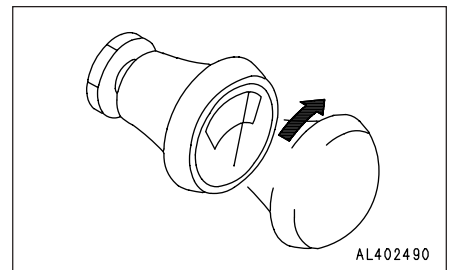

- Do not spray out the washer fluid continuously for more than 10 seconds.
- Do not try to spray out the washer fluid when the washer tank is empty.

3. REAR WIPER SWITCH

This switch operates the rear wiper.

It also acts as the window washer switch.

Operate the switch as follows.

- Window washer only
Press the switch to the OFF position to spray out water.

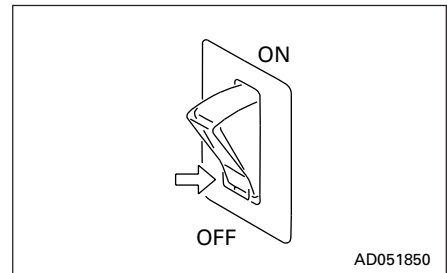

- Wiper only
Press the switch to the ON position to operate the wiper.

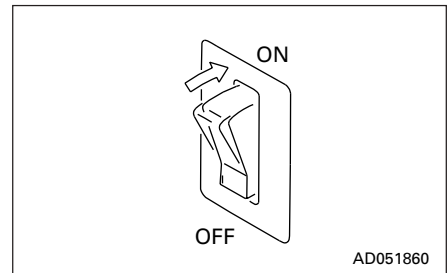

- Wiper and window washer
Press the switch to the ON position for the wiper, then keep the switch pressed to the ON position to spray out water.

Be careful of the following when using the wiper and washer.

- Do not spray out the washer fluid continuously for more than 10 seconds.
- Do not try to spray out the washer fluid when the washer tank is empty.

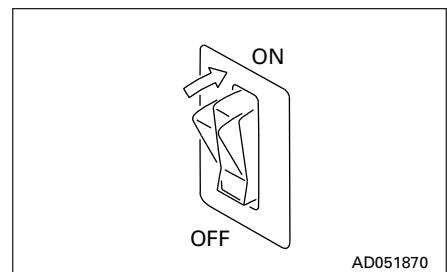

4. FRONT WORKING LAMP SWITCH

WARNING
Always turn the working lamp off before traveling on public roads.

The front working lamp lights on when pushing this switch to ON.

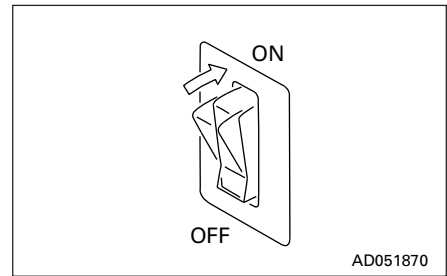

5. REAR WORKING LAMP SWITCH (OPTION FOR MACHINE WITH CAB)

WARNING
Always turn the working lamp off before traveling on public roads.

The rear working lamp lights on when pushing this switch to ON.

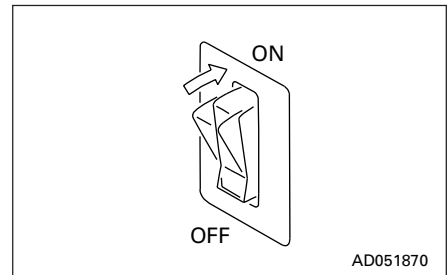

6. ROTARY LAMP SWITCH (OPTION FOR MACHINE WITH CAB)

The rotary lamp lights on when pushing this switch to ON.

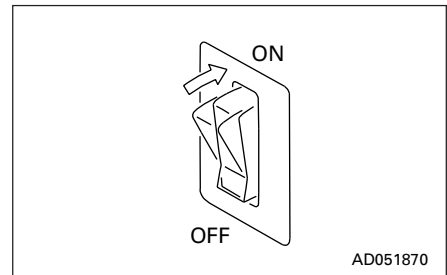

7. HEATER SWITCH

Position ①: OFF

Position ②: Lo

Position ③: Hi

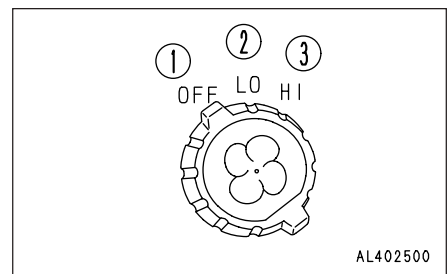

8. ACCELERATOR PEDAL STOPPER LEVER

⚠ WARNING

When carrying out the warming-up operation, always apply the parking brake, set the directional lever to the N position and the work equipment control lever to the HOLD position, and lock with the safety lock.

This lever holds the accelerator pedal at the position for warming up (engine speed: 1400 – 1500 rpm).

Position **(A)**: HOLD

Depress the accelerator pedal half way (approx. 1600 rpm), then apply the stopper lever.

Position **(B)**: RELEASE

Depress the accelerator pedal slightly from the HOLD position, then return the stopper lever by hand to release the accelerator pedal.

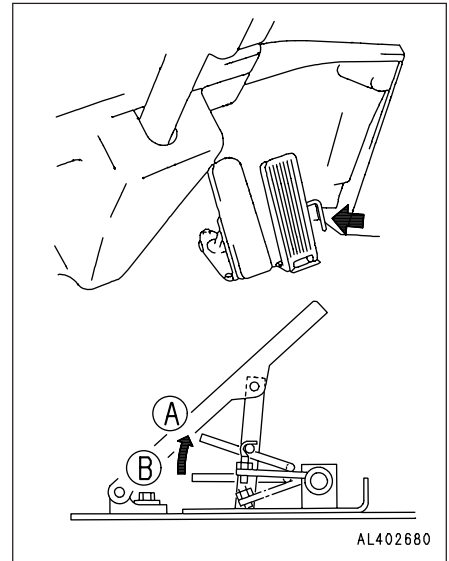

9. VENT SELECTOR LEVER

This lever selects the vent for the hot air to warm the operator's cab.

Position **(A)**: All hot air sent to the vent for the front glass defroster

Position **(B)**: Divided between vent for heat and vent for front glass defroster

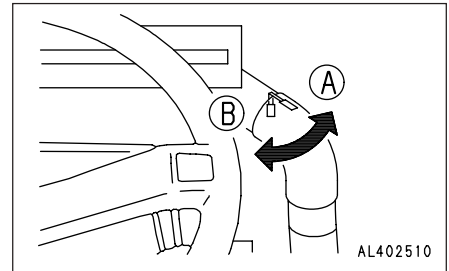

28.2 REAR WINDOW

Open the rear window of the cab when opening or closing the tilt hood.

Hold lever **(1)** by hand and pull. The rear window will open. When closing the rear window, push in the bottom of the rear window securely towards the cab.

NOTICE

Except when opening the rear window, always keep it locked to prevent vandalism.

Check the direction of the key groove on the lever to check that it is locked.

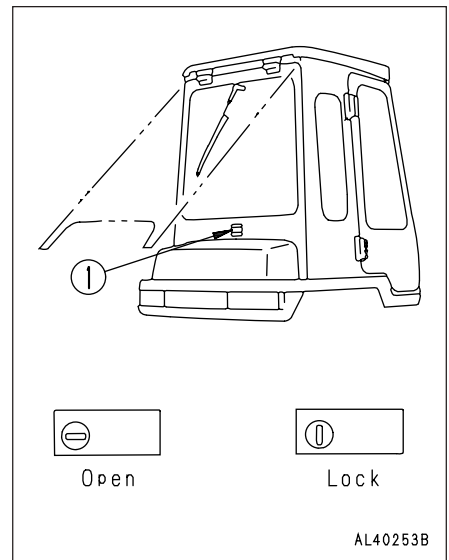

28.3 CHECK AND MAINTENANCE

28.3.1 CHECK WINDOW WASHER FLUID LEVEL, ADD FLUID

Check the level of the window washer fluid in tank ①. If the level is low, add automobile washer fluid. Be careful not to let dust get in when filling the tank.

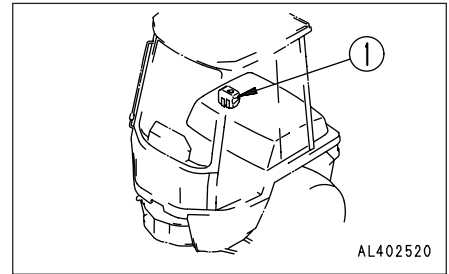

AL402520

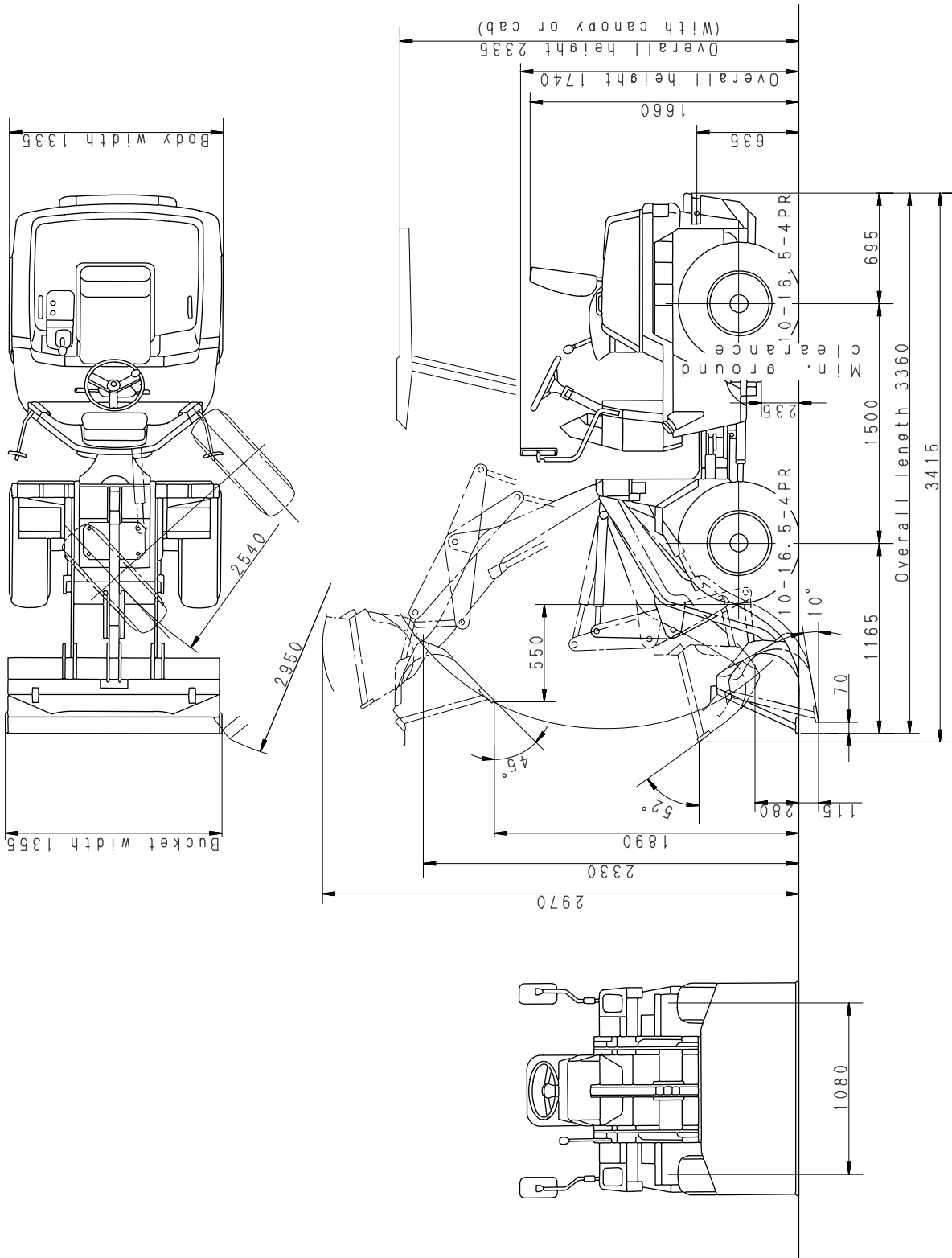

AL40240B

WA30-5**PERFORMANCE**

● Bucket capacity		0.4 m ³
● Normal load		6.3 kN (640 kgf)
● Travel speed	Forward	15.0 km/h
	Reverse	15.0 km/h
● Max. rimpull		25.5 kN (2,600 kgf)
● Min. turning radius	Outside of chassis	3,610 mm
	Center of outside tire	3,060 mm

WEIGHT

● Operating weight	Including 1 operator (55 kg, 110 lb) and a canopy	2,555 kg (5,110 lb)
	Including 1 operator (55 kg, 110 lb) and a cab	2,705 kg (5,410 lb)

ENGINE

● Model	Komatsu 3D84E-3D diesel engine
● Flywheel horsepower	21.3 kW/2,500 rpm
● Max. torque	90 N•m/1,600rpm (9.2 kgf•m/1,600 rpm)
● Starting motor	12 V 2 kW
● Alternator	12 V 40 A
● Battery	12 V 60 Ah x 1 piece

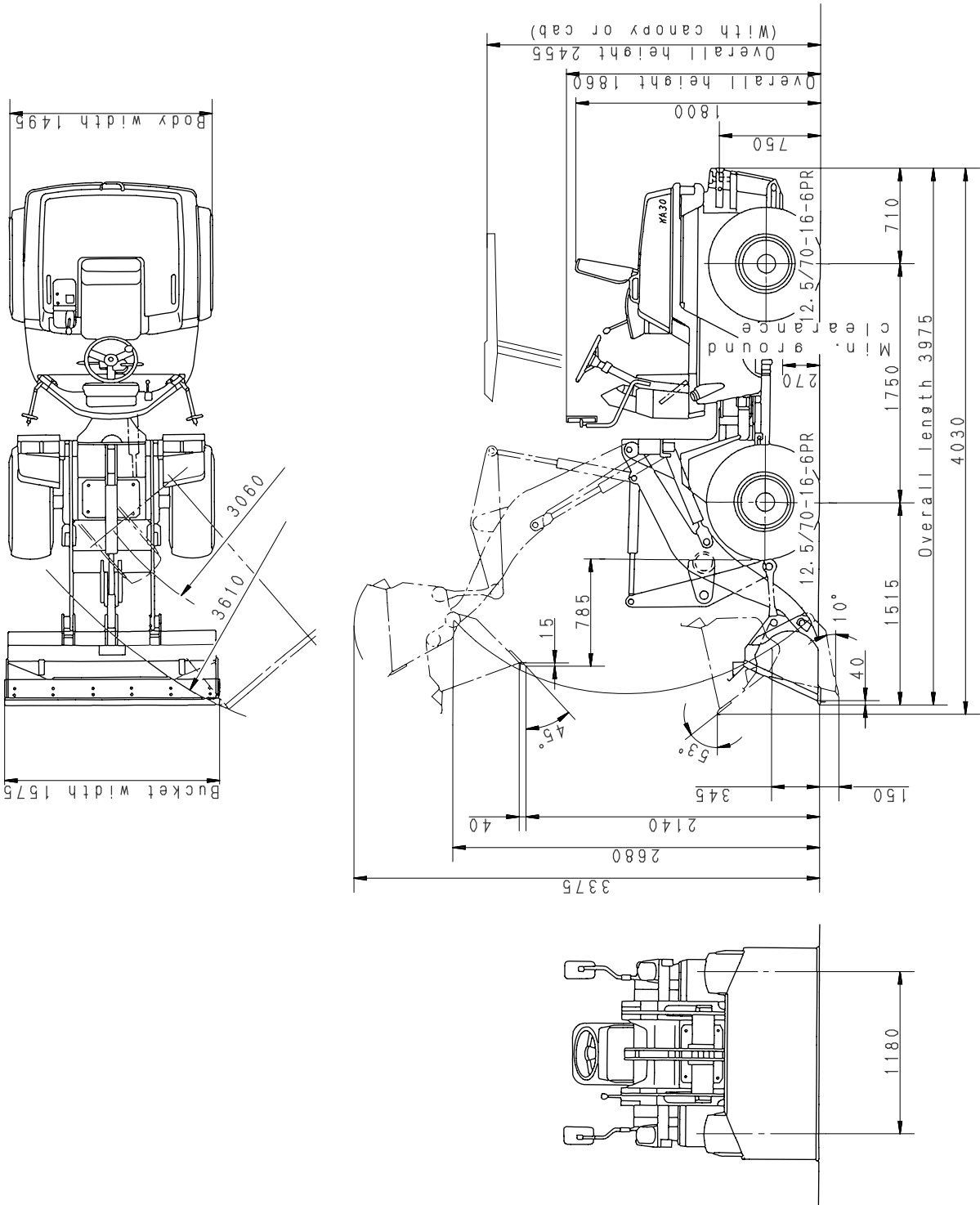

AL40241B

WA40-3**PERFORMANCE**

● Bucket capacity		0.5 m ³
● Normal load		7.8 kN (800 kgf)
● Travel speed	Forward	15.0 km/h
	Reverse	15.0 km/h
● Max. rimpull		31.9 kN (3,250 kgf)
● Min. turning radius	Outside of chassis	3,820 mm
	Center of outside tire	3,210 mm

WEIGHT

● Operating weight	Including 1 operator (55 kg, 110 lb) and a canopy	3,055 kg (6,110 lb)
	Including 1 operator (55 kg, 110 lb) and a cab	3,205 kg (6,410 lb)

ENGINE

● Model	Komatsu S3D84E-3B diesel engine
● Flywheel horsepower	27.2 kW/2,500 rpm
● Max. torque	123 N•m/1,600 rpm (12.5 kgf•m/1,600 rpm)
● Starting motor	12 V 2 kW
● Alternator	12 V 40 A
● Battery	12 V 60 Ah x 1 piece

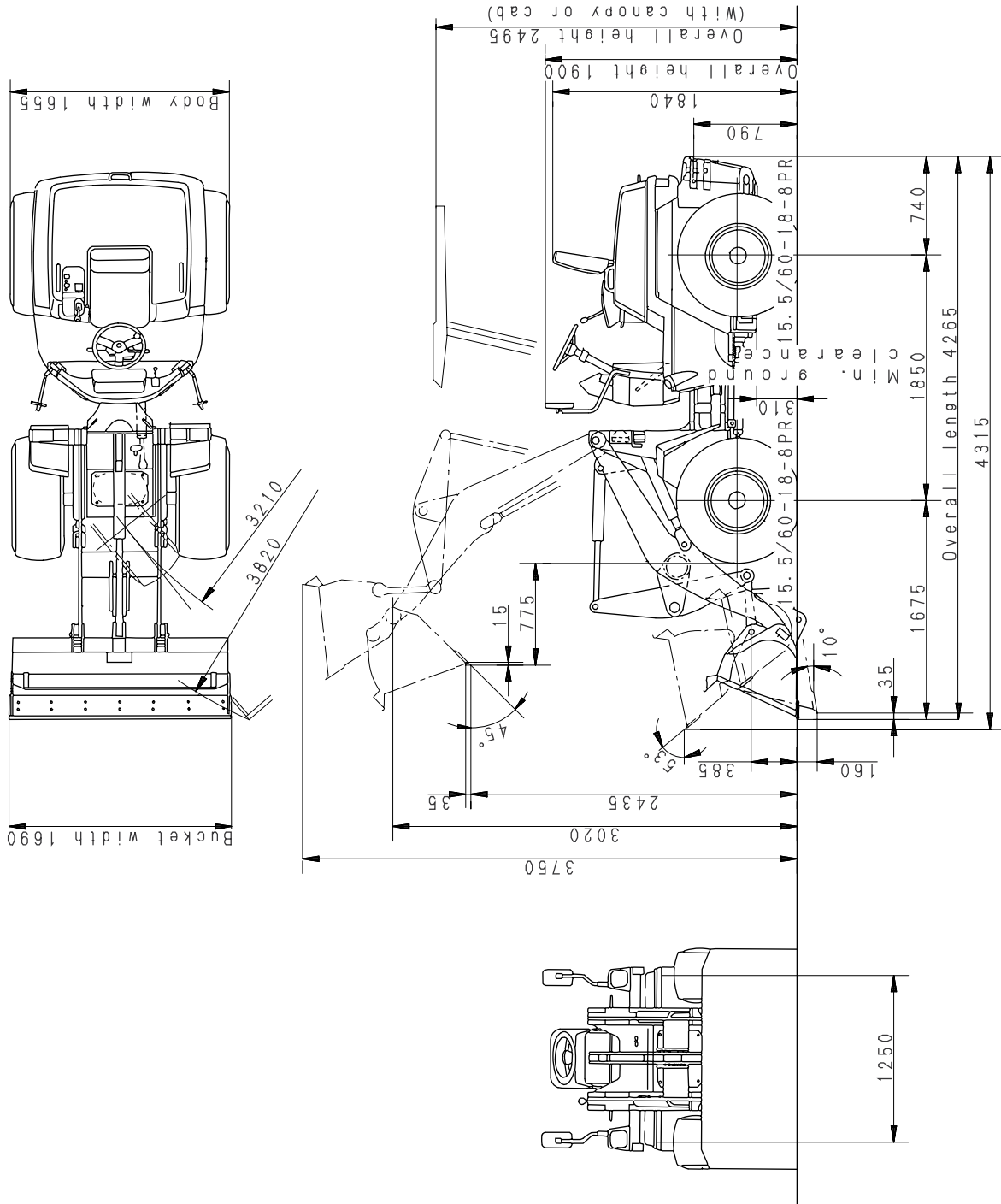

AL40242B

WA50-3**PERFORMANCE**

● Bucket capacity		0.6 m ³
● Normal load		9.4 kN (960 kgf)
● Travel speed	Forward	15.0 km/h
	Reverse	15.0 km/h
● Max. rimpull		32.4 kN (3,300 kgf)
● Min. turning radius	Outside of chassis	3,930 mm
	Center of outside tire	3,210 mm

WEIGHT

● Operating weight	Including 1 operator (55 kg, 110 lb) and a canopy	3,445 kg (6910 lb)
	Including 1 operator (55 kg, 110 lb) and a cab	3,605 kg (7210 lb)

ENGINE

● Model	Komatsu S3D84E-3B diesel engine
● Flywheel horsepower	27.2 kW/2,500 rpm
● Max. torque	123 N•m/1,600 rpm (12.5 kgf•m/1,600 rpm)
● Starting motor	12 V 2 kW
● Alternator	12 V 40 A
● Battery	12 V 60 Ah x 1 piece (75D31R)

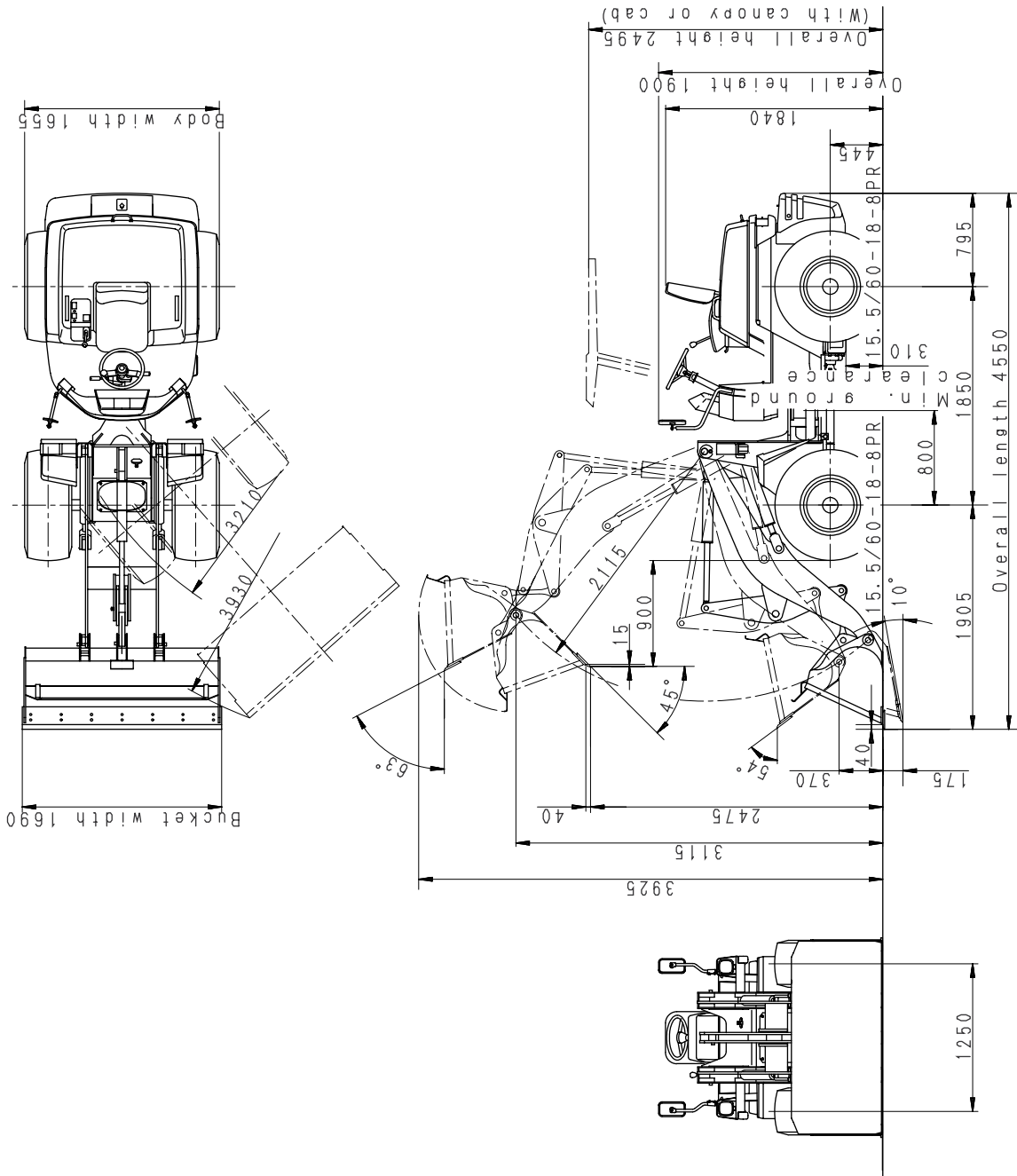

AK40243B

MEMO