

David Williams

DAVID BROWN



**DRIVER'S
GUIDE**

850, 880 and 990 TRACTORS

SAFETY POINTS

- Don't operate the independent foot brake when travelling in the higher gears.
- Don't run on the roadway without locking the two foot brake pedals together.
- Don't run the PTO or Belt Pulley without a guard.
- Don't wear loose clothing near moving parts of the tractor, engine, or implements.
- Don't attempt to start the engine in gear.
- Don't leave the ignition or isolating key in the tractor when unattended, especially where children have access.
- Don't swerve or turn sharply at speed.
- Don't let the clutch in suddenly on a slope, or brake fiercely if running backwards down hill, or the tractor may rear up.
- Don't use the differential lock on the public highway.
- Don't try to make a sharp turn unless the differential lock is out of engagement.
- Don't operate the tractor on dangerously steep ground. Move cautiously on steep slopes, the sudden swing of a heavy implement, or the pull of a trailer, may cause trouble. Use the clutch, brakes, throttle and steering *slowly*. Beware especially of slippery surfaces.
- Don't carry passengers on the tractor or linkages.
- Don't turn with a projecting implement without making sure there is room for it.
- Don't hitch trailed implements above the centre line of the rear axle.

INTRODUCTION

This booklet has been made pocket size so that the driver can always have a copy with him until he becomes thoroughly familiar with controls, adjustments, and attachments.

Desire to keep the book small has compelled a brief and direct approach which is nevertheless comprehensive. A little practice, paying careful attention to the details given, will enable the user to obtain the very high quality results of which the David Brown tractor is capable.

The contents of this book are intended to cover all operational details for the 850, 880 and 990 Tractors in the Standard and Live-drive versions and also the Narrow models of the 850 and 880 tractors, and those fitted with creeper gears. A very brief reminder of maintenance periods is also given, but attention is drawn to the Maintenance Book, supplied with every tractor. This contains full maintenance instructions, details of servicing, approved lubricants and fuels, tractor data, accessories and allied equipment.

Before operating the tractor please read the Safety points, inside the front cover, most of which apply to all tractors.

DAVID BROWN TRACTORS LIMITED,
MELTHAM,
HUDDERSFIELD,
YORKSHIRE.

First Edition October 1961
Second Edition April 1963
Third Edition August 1963
Reprinted April 1964

Publication No. DBT 495

page 1

CONTENTS

	<i>Page</i>
PRECAUTIONS WITH A NEW TRACTOR - - -	3
STARTING THE DIESEL ENGINE - - -	3
Stopping the engine - - -	4
CONTROLS - - -	5
12-Speed Gearbox - - -	7
IMPLEMATIC SYSTEM - - -	10
Description of Controls - - -	10
USING IMPLEMENTS WITH DEPTH WHEEL - -	13
Using TCU to overcome slip - - -	14
Linkage adjustment when using TCU - - -	14
USING IMPLEMENTS WITHOUT DEPTH WHEEL -	15
USING NON-GROUND ENGAGING IMPLEMENTS -	17
USING HYDRAULICALLY OPERATED EQUIPMENT	18
DIFFERENTIAL LOCK - - -	19
CATEGORY I and II LINKAGES - - -	20
Check Chains and Lift Rods - - -	20
Linkage Setting for Category I Implements - - -	21
Linkage Setting for Category II Implements - - -	22
CATEGORY I LINKAGE - - -	23
LIFT LATCH - - -	23
WHEEL WIDTHS - - -	26
Track Setting for Ploughing - - -	26
Front Track Adjustment - - -	26
Rear Track Adjustment - - -	29
TYRE PRESSURES - - -	29
BALLAST - - -	29
UNIVERSAL DRAWBAR - - -	30
PICK-UP HITCH - - -	32
PERMANENT DRAWBAR - - -	34
OVERLOAD RELEASE - - -	34
MAINTENANCE REMINDER - - -	36

page 2

PRECAUTIONS WITH A NEW TRACTOR

Although every engine is tested and part run-in at the factory care should be taken during the first 25 to 50 hours use. Avoid excessive speeds or heavy loading. Do not allow the engine to labour, change to a lower gear instead. Use the middle range of engine speeds from 1400 to 1800 rev/min. If possible use light loads to begin with and gradually increase the loading until the engine is fully run-in. If high speed or heavy loading must be used, keep this down to very short periods interspersed with periods of light load.

Periods of idling should be avoided as the rate of carbon formation is fairly high at low temperatures.

After 50 hours, change the engine oil and filter element, drain and flush the transmission gearbox and final drive reduction housings and clean the magnetic filter. Refill with new oil. Check the valve clearances and tightness of cylinder head and main external nuts and bolts.

STARTING THE DIESEL ENGINE

1. With fuel in the tank and the tap turned on, pull the fuel cut-off rearward to the running position, and drop into the retaining slot.
2. Open the throttle wide (towards the driver).
3. **Put the gear lever in neutral.**
4. Switch on the isolator.
5. Depress the clutch and press the starter button.

Release the starter button immediately the engine runs and close the throttle to give about 1000 rev/min to warm up. Check that the oil warning light goes out.

STARTING IN COLD WEATHER

The wing nut underneath the Injection Pump should be screwed in before trying to start the engine. As soon as the engine is running the screw must be slackened otherwise erratic running with black exhaust will occur. In conditions when starting is difficult the use of ether or a proprietary starting fluid is recommended. This should be used on the felt attached to the plastic plug in the pre-cleaner or manifold. Replace and press starter immediately. When starting is difficult, short presses on the starter will be of no avail. The

page 3

engine should be kept turning by the starter until the engine runs unaided. However, if it fails to run, release the starter button after 25 seconds and wait 20 seconds before trying again, otherwise the batteries will be overheated and damaged.

Use of the starter places a heavy drain on the batteries and adequate running time should be allowed to enable the dynamo to replace the charge. Use of the correct grade of oil in the engine, and pressing the clutch whilst starting, will help to reduce the load on the starter.

STOPPING THE ENGINE

Reduce engine speed, lift the fuel cut-off and allow it to move forward to the stop position. Turn off the isolating switch. Do not stop the engine by turning off the fuel as this will produce air locks necessitating complete venting of the fuel system.

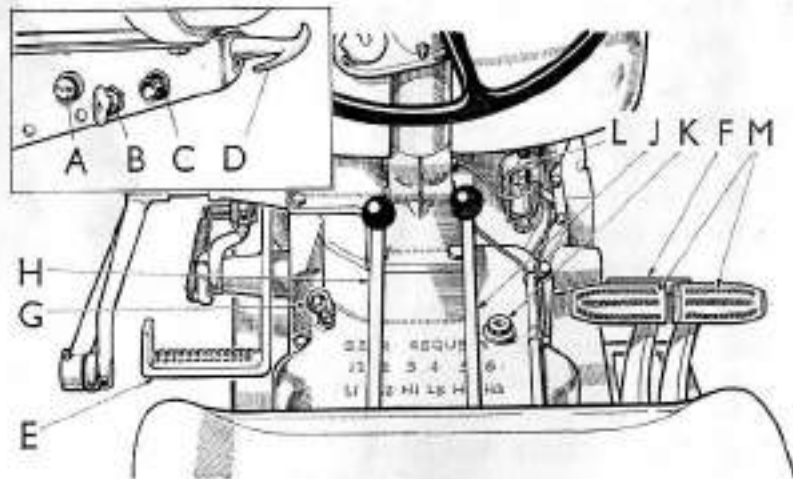

FIG. 1. Controls

- | | |
|----------------------|-----------------------------|
| A. Fuse Holder. | G. Transmission Dip-stick. |
| B. Isolating Switch. | H. Range Lever. |
| C. Starter Button. | J. Gear Lever. |
| D. Fuel Cut-off | K. Transmission Filler Plug |
| E. Clutch Pedal | L. Fuel Tap and Water Trap |
| F. Locking Bar. | M. Brake Pedals. |

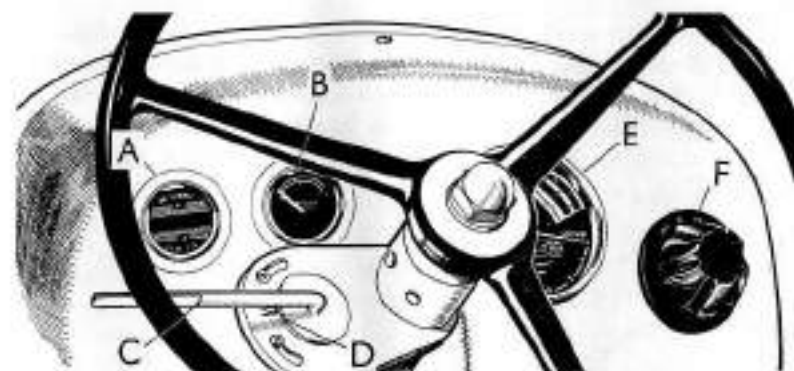

FIG. 2. Dash Panel

- | | |
|--|--|
| A. Warning Lights.
(Oil and Charge) | D. Rated Speed Setting
(1800 rev/min) |
| B. Water Temperature (U318) | E. Tractormeter |
| C. Throttle Lever. | F. Lighting Switch |

CONTROLS

The engine and tractor controls are shown in Fig. 1 and 2.

FUEL TAP

Fitted to the top of the water trap and sediment bowl under the fuel tank. The fuel is "on" when unscrewed fully. It should only be closed for servicing purposes.

OIL WARNING LIGHT

The amber light is illuminated when oil pressure is too low. Ensure that it lights when the isolating switch is turned on and goes out when the engine runs.

NO CHARGE WARNING LIGHT

The red light is illuminated when the isolating switch is turned on but should extinguish as soon as the dynamo commences to charge.

THROTTLE LEVER

When fully rearwards the diesel engine is governed to its maximum speed. The control lever is provided with a guide for easy setting to the rated speed. This position should be used for most purposes to conserve fuel and engine life. It also gives a PTO speed of 540 rev/min.

BRAKES

Twin foot pedals at the right-hand side give independent control of the brakes for steering in confined spaces. The locking bar F, Fig. 1 must be used to connect them together for use on the road. Individual use may cause a dangerous swerve besides giving only half braking power.

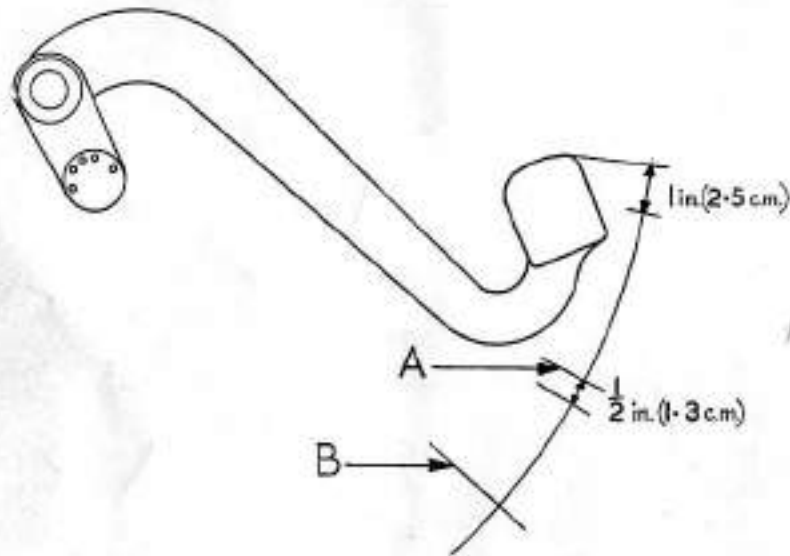

FIG. 3. Livedrive Clutch Positions

- A. Stage 1—Transmission Clutch disengaged.
- B. Stage 2—PTO Clutch also disengaged.

LIVEDRIVE CLUTCH

There are two main stages of pedal movement. Stage 1—Complete disengagement of the transmission clutch is denoted by an increase in pedal pressure. In practice the pedal should always be pressed to this point. "Easing" of the clutch to reduce forward speed, when bailing etc., to allow the implement to clear a heavy

page 6

patch, is detrimental to the life of the clutch plates. When moving off with a loaded trailer on road haulage, engine speed should be kept as low as possible, full engagement of the clutch should be obtained as quickly as possible, then, the throttle opened. **The clutch should not be operated at full engine speed or excessive wear will result.**

Stage 2—Fully depressing the clutch pedal also disengages the PTO. Between stages 1 and 2 there is a short buffer stage of constant pressure to prevent accidental slipping of the PTO clutch when only using the transmission clutch. If the PTO clutch is not used frequently, the pedal should be fully operated once a week and the PTO "freed" to prevent binding of the plates.

12-SPEED GEARBOX (Creeper Gears)

The creeper gear control lever is fitted in front of the range of gear levers normally found on the 6-speed tractors. This lever has two positions. (See charts on pages 8 and 9).

Forward (SLOW) it engages the creeper gear and, with the levers as shown on the gear selection chart on the instrument panel, it provides gears 1, 2, 3, 5, 6 and 9 in the red sector of the chart.

Rearward (NORMAL) it engages direct drive and provides gears 4, 7, 8, 10, 11 and 12 as shown in the yellow sector of the gear selection chart. Operators who have previously used the 6-speed tractor will observe that these gears are identical with gears 1, 2, 3, 4, 5 and 6 on the 6-speed tractor.

Gears 1, 2 and 3 of the 12 speed gearbox provide SLOW forward speeds for planting, transplanting, hedging and ditching and similar operations.

It is recommended that the direct drive gears (creeper gear control in NORMAL) be used for continuous heavy traction such as 3 and 4 furrow ploughing. Gears 5, 6 and 9 (creeper gear control in SLOW) provide ratios fairly close to the direct drive gears and are suitable for use for light traction and PTO work.

page 7

**GEAR SELECTION FOR ROAD SPEEDS CORRESPONDING TO
A PTO SPEED OF 540 rev/min**

*ROAD SPEEDS mile/h (km/h)		Engine Speed	6 Speed Gear	12 Speed Gear
850	880			
0-45 (0-73)	0-47 (0-76)	1100	—	1
0-74 (1-19)	0-77 (1-23)	1800	—	1
0-75 (1-21)	0-78 (1-25)	1100	—	2
1-01 (1-63)	1-04 (1-69)	1100	—	3
1-15 (1-86)	1-20 (1-93)	1100	1	4
1-23 (1-98)	1-27 (2-04)	1800	—	2
1-37 (2-20)	1-42 (2-29)	1100	—	5
1-65 (2-66)	1-71 (2-76)	1800	—	3
1-68 (2-71)	1-74 (2-80)	1100	—	6
1-89 (3-04)	1-96 (3-15)	1800	1	4
1-91 (3-08)	1-98 (3-18)	1100	2	7
2-25 (3-61)	2-33 (3-74)	1800	—	5

* ROAD SPEEDS mile/h (km/h)		Engine Speed	6 Speed Gear	12 Speed Gear
850	880			
2-58 (4-15)	2-67 (4-30)	1100	3	8
2-74 (4-43)	2-84 (4-59)	1800	—	6
3-06 (4-90)	3-19 (5-14)	1100	—	9
3-13 (5-04)	3-24 (5-21)	1800	2	7
3-49 (5-61)	3-62 (5-84)	1100	4	10
4-22 (6-79)	4-37 (7-03)	1800	3	8
4-28 (6-90)	4-43 (7-14)	1100	5	11
5-01 (8-08)	5-19 (8-39)	1800	—	9
5-72 (9-20)	5-93 (9-54)	1800	4	10
7-00 (11-30)	7-25 (11-70)	1800	5	11
7-80 (12-50)	8-15 (13-10)	1100	6	12
12-80 (20-60)	13-30 (22-40)	1800	6	12

* 850 tractor on 10-28 tyres, 880 on 11/12-4-28 tyres and 990 on 11-32 tyres.

For oversize tyres the road speeds are increased by approx. 8%.

OPERATION OF THE IMPLEMATIC SYSTEM

Four distinct systems are available.

System 1 For use with implements having a depth wheel. (TCU can be used to overcome wheel slip).

System 2 For use with ground engaging implements without a depth wheel. (Known as "Draught Control").

System 3 For non-ground engaging implements which require to be held at a certain height above the ground and also for semi-ground engaging implements without depth wheel *i.e.* mowers, weeders or seeders which do not produce sufficient alteration in the length of the top link to give satisfactory control with System 2. (Known as "Height Control").

System 4 Operation of equipment on the external hydraulic supply.

Note—Do not try to master all four systems at once since this will only lead to confusion. Ignore the systems which do not immediately concern you and turn to the following pages for the operation of the system required.

DESCRIPTION OF CONTROLS

TOP LINK CABLE

This cable transmits impulses to the control box and control valve, varying the oil pressure in the system according to the signals conveyed.

The attachment of the cable is changed according to the system in use. For system 1 it is connected to the top link as shown in Fig. 6. This extends the cable and allows TCU to be applied when required. For system 2 it is similarly connected to the top link so that changes in length of the top link with changes in draught, are conveyed to the control box. For System 3 the cable is connected to the ramshaft bracket as shown in Fig. 9 so that changes in height (position of the ramshaft) are conveyed to the control box. For System 4 the cable is stowed on the ramshaft bracket with the inner cable free. This allows a "hold" position to be selected at will by means of the control lever.

CAUTION—Do not attempt to connect or disconnect the top link cable when an implement is raised on the linkage.

page 10

CONTROL LEVER

Shown at A Fig. 4 this is the Implematic control lever and has two sets of positions according to whether the system is set for use with implements or for external usage.

PRE-SET GUIDE

Shown at B Figure 4, this is not a control but an adjustable guide which can be held in any position by tightening locking screw D.

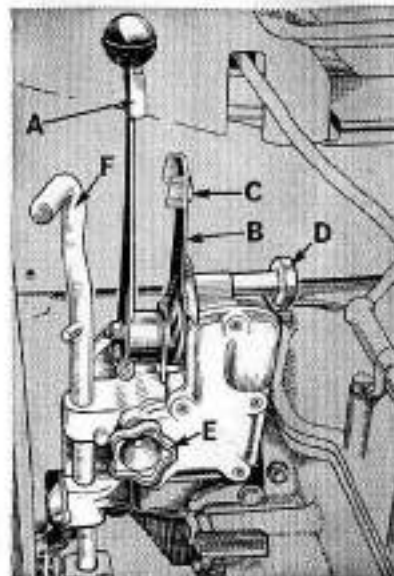

FIG. 4. Controls

- A. Control Lever.
- B. Pre-set Guide.
- C. Latch.
- D. Locking Screw
- E. TCU Hand Wheel.
- F. Hand Brake (Turn outwards and lower to release).

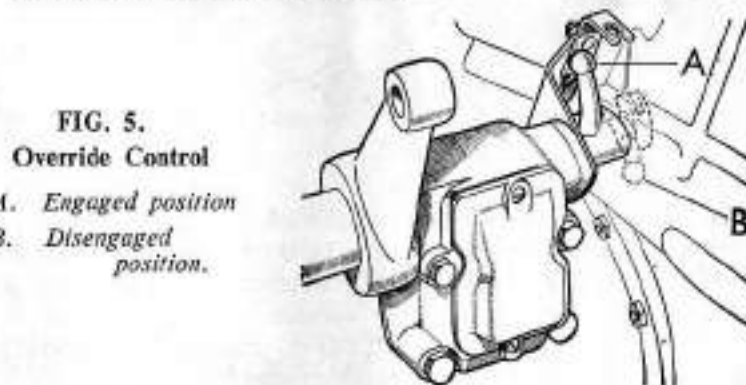

FIG. 5.

Override Control

- A. Engaged position
- B. Disengaged position.

page 11

The Latch C can be turned to engage with the Control Lever to act as a positive positioning stop. The control lever is shaped so that when required it may be easily aligned with the pre-set guide by touch only.

VERRIDE CONTROL

Shown in Fig. 5, this lever at the right-hand end of the ramshaft throws the pump into "hold" when turned upwards. Normally it is coupled to the end of the ramshaft so that the hold position is obtained when the links reach the top of their travel. For special uses the lever may be shifted to the right and turned rearwards and downwards. This disconnects it from the ramshaft and "hold" is then obtained by the Control Lever when required. To re-engage, push the lever to the left and move it up and down to locate the internal connection pins and push fully home to ensure a positive engagement with the ramshaft.

Note. When the Override Control is disengaged the tractor should not be operated for long with the Control Lever in "Lift", otherwise the pump will be operating at full pressure, and the transmission oil will overheat.

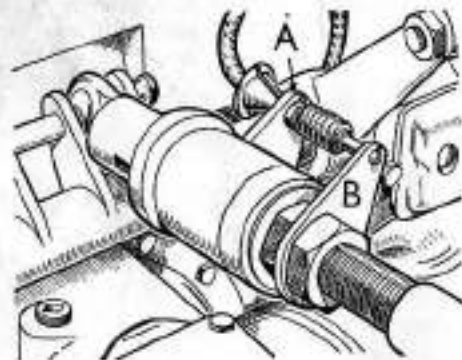

FIG. 6.
Response Unit
and Cable

- A. Outer cable attachment.
- B. Inner cable attachment

TCU HANDWHEEL

Shown at E Fig. 4 this wheel controls the amount of TCU applied when the Control Lever is put in the TCU position. The wheel has approximately five whole turns of movement with six 'clicks' per turn. When using implements without depth wheels *unscrew* the TCU Handwheel to prevent TCU oil pressure from overriding or reducing the effectiveness of depth control.

page 12

OPERATION OF SYSTEM I (Implements with depth wheel and use of TCU)

CONTROL SETTINGS

1. Ensure that the Top Link Cable is connected to the top link (Fig. 6).
2. Move the Pre-set Guide until the TCU mark lines up with the arrow on the body of the housing.
3. Ensure that the Override Control is engaged with the Ramshaft.

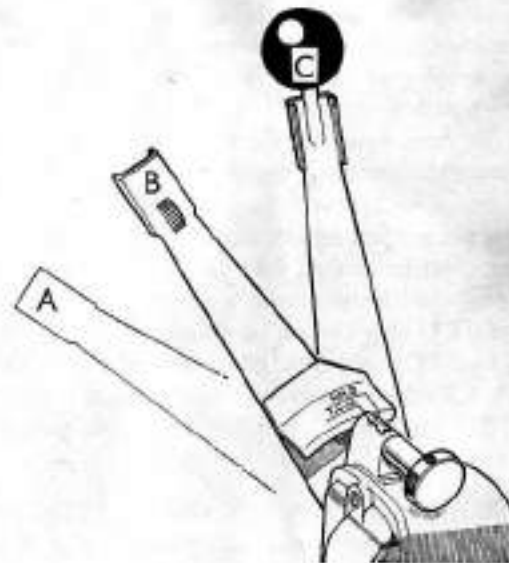

FIG. 7. Control Position for Implements with Depth Wheel

- A. Lower Position.
- B. TCU Position.
- C. Raise Position.

OPERATION

At the commencement of a row push the Control Lever fully forward to lower the implement into work. The slower the lever is moved the slower the implement will drop. At the end of a row pull the lever fully rearwards and the implement will rise to the top and hold there.

page 13

USING TCU TO OVERCOME SLIP

As an initial setting, screw the TCU Handwheel in a few "clicks". On medium soil a good starting point would be 8 clicks for a 2-furrow plough, 18 for a 3-furrow and 28 for a 4-furrow plough. At the commencement of the furrow push the Control Lever fully forward and when the plough has reached its full working depth pull the Lever back into line with the Pre-set Guide, i.e. into the TCU position. If this is not sufficient to stop wheel slip, screw the Hand Wheel in a few more "clicks". This setting will then probably be suitable for the remainder of the field, it only being necessary to bring the control lever into line with the Pre-set Guide to apply the set amount of TCU. By counting the number of "clicks" used, the setting can be found again under similar conditions.

At the end of a furrow, when TCU is being used, it is only necessary to pull the control lever fully rearwards to lift the plough in the normal way.

In order to get proper penetration of the plough at entry, the Control Lever must be pushed **fully** forward and not brought back to the TCU position till the proper working depth is reached. The application of TCU should not be delayed too long or wheel slip will occur before TCU becomes effective and additional TCU will be of no avail. The correct timing and anticipation of the required quantity of TCU is a matter of skill which comes very quickly with a little practice.

LINKAGE ADJUSTMENT WHEN USING TCU

Because of the different forces acting on the plough when using TCU a slight re-adjustment to the settings may be required.

1. The top link should be shortened slightly to counteract the tendency of the plough to ride out of the ground. It should, however, be used as long as possible consistent with obtaining the required depth.
2. To correct a tendency of the front furrow to become shallow, lengthen the right hand levelling lever slightly.
3. On soft ground raise the depth wheel slightly to maintain the correct depth. Some of the weight is taken off the depth wheel and so it will not sink so deeply into soft earth.

page 14

OPERATION OF SYSTEM 2 "DRAUGHT CONTROL"

(Implements without depth wheel)

CONTROL SETTINGS

1. Ensure that the Top Link Cable is connected to the top link (Fig. 6).
2. Set the Pre-set Guide initially with the TCU mark in line with the arrow on the body of the housing.
3. Ensure that the Override Control is engaged with the Ramshaft.
4. Ensure that the TCU Handwheel is fully unscrewed.

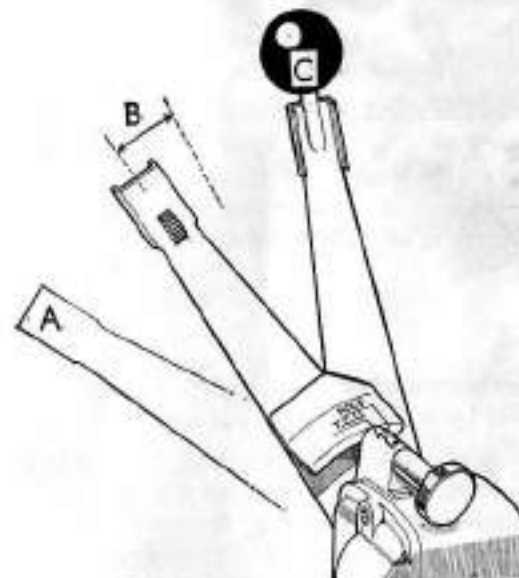

FIG. 8. Control Positions for Implements without Depth Wheel

- A. Lower Position.
- B. Depth Control Range.
- C. Raise Position.

OPERATION

A trial run will be necessary to find the required position of the Pre-set Guide. At the beginning of the furrow push the Control Lever fully forward and, when the plough has reached its working

page 15

depth, bring the lever back until the required depth is maintained. This position will be slightly rearwards of the Pre-set Guide. Move the Control Lever further rearwards to reduce depth, or forward to increase depth. When the required depth has been found, move the Pre-set Guide into alignment with the Control Lever and lock it with the locking screw. On subsequent furrows it will only be necessary to move the Control Lever from the raise position to the Pre-set Guide at the beginning of the furrow, and pull the lever fully rearwards at the end of the furrow. If conditions are such that penetration is slow it may be necessary to move the lever fully forwards to lower and then back to the Pre-set Guide.

MARKING OUT

In order to obtain stability when ploughing at very shallow depths, especially with 3 or 4 furrow ploughs, the pitch must be reduced. For marking out, the level of the plough is set so that only the rear body touches the ground and the pitch reduced until only the underside of the plough is virtually scraping the soil to produce a mark.

USE OF TCU

If wheel slip occurs when using implements without depth wheel the Differential Lock should be used as described on page 19.

The spectacular results obtained with TCU and depth wheel implements cannot be achieved without a depth wheel. However, under certain conditions when the top is greasy, TCU can be of some assistance. A moderate amount of TCU may be applied by screwing in the handwheel, at the same time a slight adjustment of the Control Lever towards increased depth may be necessary.

TCU must not be applied to such an extent that depth is excessively reduced. Some loss in response to depth changes is to be expected so, except when it is particularly required, the TCU Handwheel must be fully unscrewed.

OPERATION OF SYSTEM 3 "HEIGHT CONTROL"

(Light draught or non-ground engaging implements)

CONTROL SETTINGS

Lower the linkage and disconnect the cable from the top link.

1. Engage the nipple of the inner cable in the fork on the override control "A" and attach the outer cable to the bracket "B" on the ramshaft housing (Fig. 9).
2. Unlock the pre-set guide and push it fully forward.
3. Raise the linkage by pulling the control lever rearward, then push the lever slowly forward until the implement is lowered to the required position.
4. Turn the stop on the pre-set guide into the engaged position and move the guide to the rear until the stop touches the control lever, then lock the guide by tightening the hand nut.

Caution—Do not attempt to connect or disconnect the top link cable when an implement is raised on the linkage.

OPERATION

To raise the implement, move the control lever fully to the rear. To lower the implement to the same height as set previously, push the control lever forward until it contacts the stop on the pre-set guide.

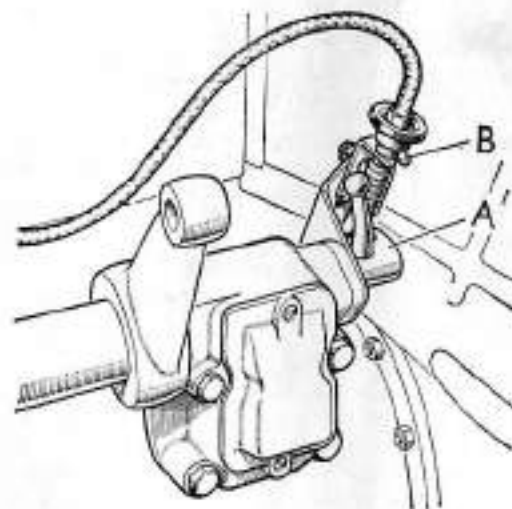

Fig. 9.
Ramshaft Bracket
A. Override Control.
B. Ramshaft Bracket.
(with cable
connected).

OPERATION OF SYSTEM 4

(External hydraulic equipment operated by the tractor hydraulic supply)

CONTROL SETTINGS

1. Disconnect the top link cable and reconnect it on the ramshaft bracket but with the inner cable free.
2. Lower the links or place them in the stowed position on the lift latch. Leave the override control in the disengaged position if this is done.
3. Lock the pre-set guide with the "hold" mark against the arrow head on the top of the housing.

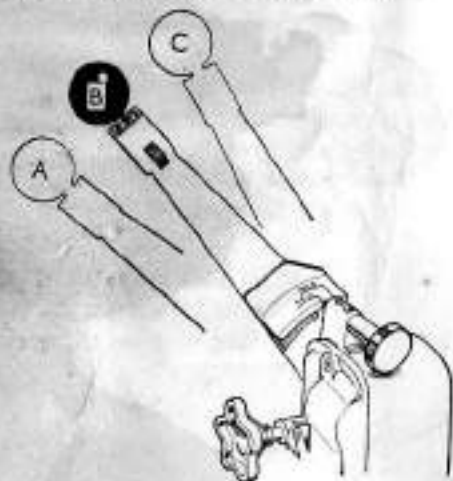

Fig. 10.

Control Lever Position for External Equipment

(Outer cable stowed on ramshaft housing bracket and inner cable disconnected)

- A. Lower position.
- B. Hold position.
- C. Raise position.

OPERATION

It is advisable to ensure that there is sufficient oil in the sump to feed the external system, approximately $\frac{1}{2}$ gallon extra for a trailer or loader. Up to 1 gallon extra may be added when necessary.

The control lever has three positions as shown in Fig. 10. When in the rearward position, oil is pumped to the external equipment. The "hold" position is obtained when the control lever is in line with the pre-set guide. The oil is then locked in the external equipment. When pushed fully forward, the oil is free to return to the sump.

If a three-way valve is fitted, the valve for the internal system should be closed and the one for the external system opened. The tractor should not be operated with all three valves closed or for long periods with the control lever fully rearwards when the override control is disengaged. This causes the pump to work at full pressure with unnecessary wear and heating of the oil.

DIFFERENTIAL LOCK

This locks the drive so that both rear wheels turn at the same speed, thus one wheel cannot slip unless the other one does.

ENGAGING

To engage differential lock press the pedal firmly with the right heel before slip occurs. If slip has occurred close the throttle or de-clutch before pressing the Differential Lock Pedal. Re-engage the clutch gradually.

Maintain a steady pressure on the pedal until the Differential Lock engages. Ensure that the pedal is pressed down the full amount. Retain the lock in engagement by resting the heel on the pedal.



FIG. 11.
Differential Lock
A. Engaging Pedal.

DISENGAGING

The Differential Lock is spring loaded so as to push it out of engagement but any tendency to slip will create a binding action which will prevent it from disengaging. To disengage, it is only necessary to momentarily relieve the load or reverse the load. This is done by pressing quickly first on one brake pedal, then on the other. When ploughing it is usually only necessary to press on the landwheel brake.

If Differential Lock is used for trailer work with the brakes locked together, disengagement can be obtained by steering first to one side then to the other.

Note. If the tractor is stopped and the Differential Lock remains in engagement, it may be released by momentarily reversing the tractor.

Warning. The Differential Lock must not be used in the higher gears, at high speeds, or on the public highway.

CATEGORY I AND II LINKAGES

(880 and 990 Tractors)

CHECK CHAINS—990 TRACTORS

The universal drawbar must be in the top position with the drawbar stowed. The check chains are attached to the peg on the drawbar with the longer lug to the right hand side.

CHECK CHAINS—880 TRACTOR

The check chains are attached to the bracket underneath the PTO housing.

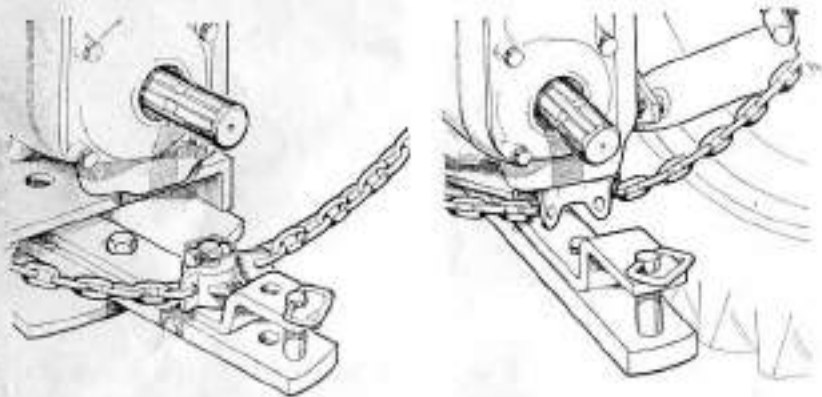

990

850-880

FIG. 12. Check Chain Anchorage

LIFT RODS

The normal length of the lift rods on 990 models is 17½ in. (45 cm) i.e., with 2 in. (5 cm) of space between the bottom end of the outer sleeve and the grease nipple.

On 880 tractors the length is 16½ in. (42 cm) i.e., with 1 in. (2.5 cm) of space between the bottom of the outer sleeve and the grease nipple.

N.B. The lift rods must never be extended to more than 3½ in. (9 cm) between grease nipple and outer tube, otherwise there will be excessive strain on the remaining thread.

page 20

LINKAGE SETTINGS FOR CATEGORY I IMPLEMENTS

The uncranked end of the lower link with the larger ball is fitted on the **inside** of the hitch bracket using the sleeve supplied in the tool box to bring the pin to the diameter of the hole in the ball. Ensure that the links are correctly handed so that the crank at the rear end is turned inwards.

The lift rods should be connected to the front hole in the link and the check chain attached in the hole immediately behind, using the pin which gives the shorter length of chain. The end of the chain and the other pin is allowed to hang loose.

Note. If the check chain is excessively tight when marking out a field, temporarily fit the right hand lower link on the outside of the hitch bracket.

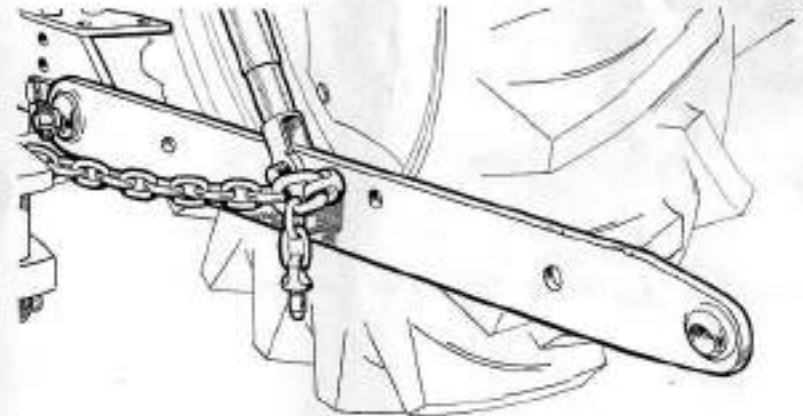

FIG. 13. Linkage Settings for Category I Implements

page 21

LINKAGE SETTINGS FOR CATEGORY II IMPLEMENTS

The cranked end of the lower link is fitted on the outside of the hitch bracket with the crank turning outwards using the pins provided through the small ball.

The lift rod is attached to the front hole in the lower link and the check chain to the hole immediately behind it.

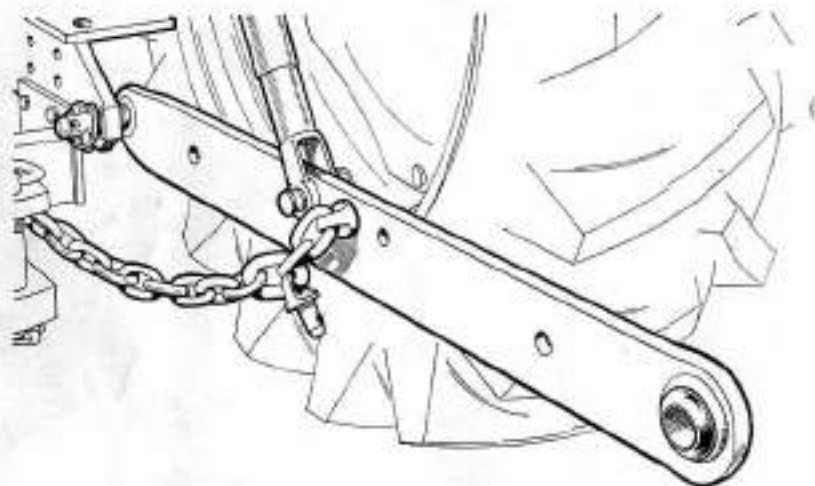

FIG. 14. Linkage Settings for Category II Implements

LIFT RODS

When not attached to the lower links *i.e.* when the drawbar is used and the lower links removed, the check chain pins should be inserted to prevent the lift rods unscrewing and falling off.

CATEGORY I LINKAGE

(850 Tractor)

The lower links should be fitted with the hole for the stabiliser bar which is 7 in. (17.8 cm) from one end, towards the rear. The cranked ends should turn outwards at the front and inward at the rear and be fitted to the inside of the hitch brackets. Attach the lift rods to the forward of the two centre holes in the lower link. The check chains should be attached at the rear holes and to the bracket under the PTO housing.

The normal length of the lift rods is 16½ in. (42 cm) *i.e.* with 1 in. (2.5 cm) between the grease nipple and the bottom edge of the outer tube. They should not be extended to more than 3½ in. (9 cm) between grease nipple and outer tube, otherwise there will be excessive strain on the remaining threads.



FIG. 15. Linkage Setting
LIFT LATCH

A Latch is provided on the left-hand lift arm for stowing the links in the top position when not in use.

When the Latch Release Knob A, Fig. 17 is turned clockwise about half a turn the links will be released. The knob will remain in this position so making the latch inoperative. When the knob is turned anti-clockwise, the links will be automatically held at the top when raised past the Latch.

With the Override Control engaged, the pump will trip into 'hold' before the Lift Latch is reached. To raise the links past the latch

with a load attached it will be necessary to disengage the Override Control as described on pages 10-12. To release the Latch with a weight on the links, the hydraulics must be put into 'lift' (with the Override Control disengaged) to support the weight before turning the knob clockwise.

The hydraulic system will return the links to the top if they drop more than 3 or 4 inches (8 to 10 cm) but whilst *transporting* implements the Lift Latch should be used.

A heavy implement should not be carried at speed over rough ground, a little care will avoid impact loads on the linkage system.

WARNING

On no account should the Linkage Locking Latch be released without supporting the links.

Without an implement on the links, stand behind the tractor, support the links in the right hand, and release the lock with the left hand. Do not use the right hand.

Never pass the hand under the lift rod and ramshaft arm. If the ram cylinder oil has drained away (or the links have been lifted by hand) the links will drop and trap the hand, resulting in serious injury.

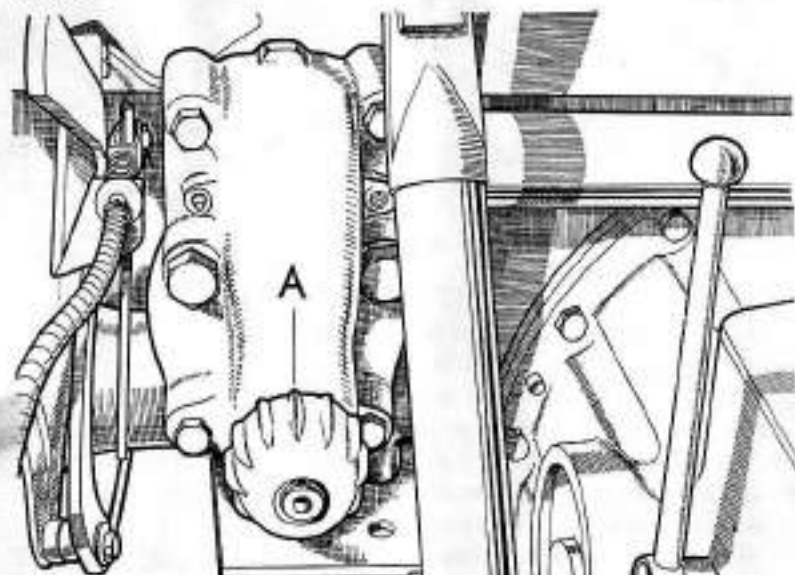

FIG. 16. Lift Latch A. Lift Latch Knob.

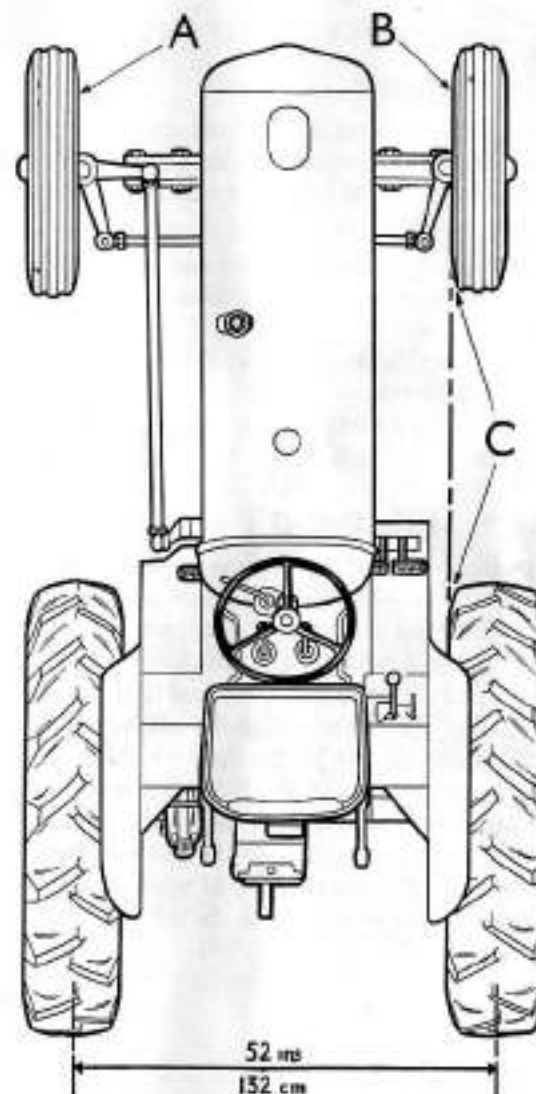

FIG. 17. Wheel Setting for Narrow Ploughs
 A. Set to 56 in. (142 cm). B. Set to 48 in. (122 cm).
 C. Insides of tyres in line.

WHEEL WIDTHS

TRACK SETTING FOR PLOUGHING

For 12 in. to 16 in. ploughs (30.5 to 40.6 cm) the rear track should be set to 56 in. (142 cm) and the front track to 52 in. (132 cm). This brings the insides of the front and rear tyres into line.

For ploughs of 8 in. to 12 in. widths (20 cm to 30 cm), the rear wheels should be set to 52 in. (132 cm) and the front axle set to its narrowest width but off-set to one side to bring the inside of the front tyre into line with the inside wall of the rear tyre. An extra hole is drilled in the right-hand end of the front axle to allow it to be taken in to the equivalent of 48 in. (122 cm) track, see Fig. 17. However, the left-hand half-axle must be taken out to the equivalent of the 56 in. (142 cm) track.

FRONT TRACK ADJUSTMENT

The axle extension is secured by two bolts A Fig. 18. These are screwed into threaded holes in the axle and do not require the use of nuts. To adjust the track width, jack up the axle, remove the adjustment nut and bolt from the track rod, remove completely the two bolts A and slide the axle extension to the required position and re-fit the bolts. (When adjusting the left-hand half of the axle, the wheels should be turned to the right so that the steering arm B does not obstruct removal of the bolts). Ensure that the spring washers are used and the bolts fully tightened. When both halves of the axle have been adjusted, re-fit the nut and bolt through the track rod to position the wheels parallel when straight ahead. All exposed holes should be plugged with the red plastic plugs provided in the tool box.

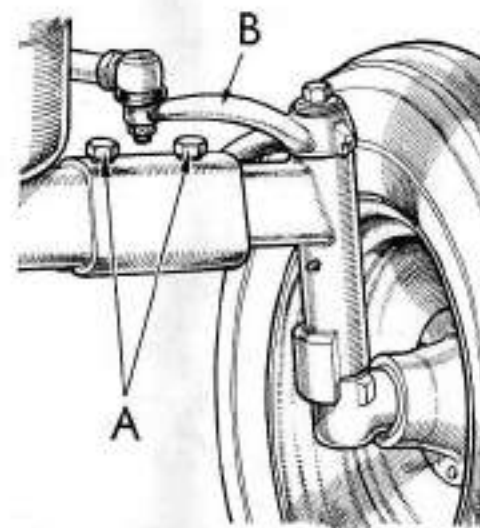

FIG. 18. Front Axle

- A. Axle securing bolts.
- B. Steering arm.

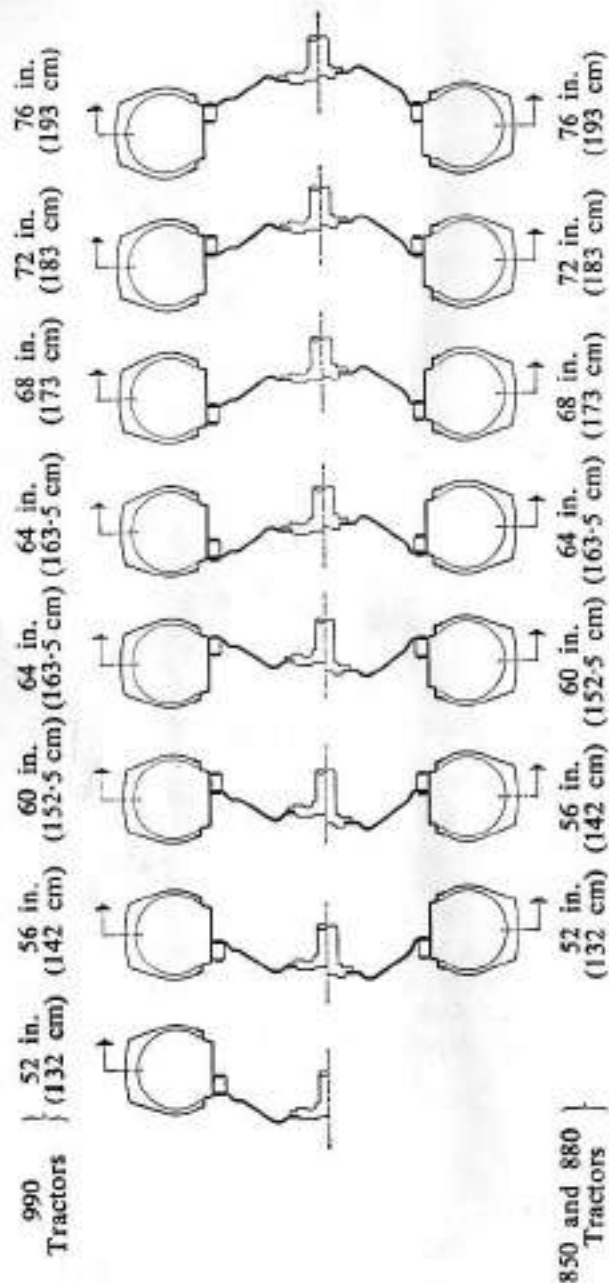

FIG. 19. Rear Wheel Settings
 Showing relative positions of rims and centres.
 (For Narrow Tractors see inside rear cover).

REAR TRACK ADJUSTMENT

The rear track width can be varied by 4 in. (10 cm) steps. The wheel centres are dished so that they can be fitted to the hub either way round. The lugs on the wheel rim are off-centre so that by fitting the wheel either way round, a variation is obtained. A further variation is obtained by fitting the wheel rim lugs either side of the dished centre. The full range of settings are shown in Fig. 19. For narrow tractors see inside the rear cover.

Note. When fitting rear wheels observe the correct direction of rotation of pneumatic tyres. The tread pattern must be such that when looking down on top of the tyre, the Vee of the tread points forward.

Important. Take care to place the jack on firm ground under a solid part of the tractor. Before removing a wheel, place some pieces of stout wood under the tractor frame to support it should the jack become dislodged.

TYRE PRESSURES

Tyres are expensive and it pays to check the pressure frequently. Incorrect pressure, either too high or too low, is the chief cause of tyre wear and damage. Check pressure once a week or more often if water ballasted.

Front tyres—all conditions 25 lb/in² (1.96 kg/cm²)*

Rear tyres—field work 12 lb/in² (0.84 kg/cm²).

Rear tyres—road work 14 lb/in² (0.98 kg/cm²).

* Pressure should be 32 lb/in² (2.24 kg/cm²) with 5-00-15 tyres (i.e. 850 tractors).

BALLAST

Wheel slip is expensive, not only because of wear but also because it wastes fuel. It should be reduced by use of TCU where possible. If extra traction is required, resort to ballasting by means of wheel and chassis weights. Alternatively, or in addition, water ballast in the tyres may be used. A special anti-freeze solution should be used where temperatures below freezing are encountered. The tyre should never be completely filled. For full details and for the correct apparatus for filling, consult your Dealer or the tyre manufacturer's literature.

UNIVERSAL DRAWBAR

(990 Tractor)

STOWED POSITION

The front end of the bar is pushed to the left side between the two pins A in Fig. 20. The rear end is secured in the offset hole B.

NORMAL TOWING POSITION

Hook the front end of the bar under pin B using the rear keyhole shaped hole. Pull rearwards into the slot and secure, with the pin provided, in any of the five holes in the drawbar plate. It may, if required, be left to swing free by inserting the pin from the underside in the hole immediately behind the drawbar plate. The maximum weight at the draw pin is 2500 lb (1135 kg).

FULL EXTENDED POSITION

Attachment is similar to the normal towing position except that the forward keyhole shaped hole is used to give a towing hitch 14 in. (35.6 cm) behind the PTO shaft. The maximum weight at the draw pin in this position is 1200 lb (545 kg).

HEIGHT ADJUSTMENT

The drawbar has three positions of height obtained by securing the drawbar in any of the three holes in the hitch brackets.

Note. The drawbar must be in the top position when an implement is fixed to the links and the check chains in use or damage will occur when lifted to the top.

PICK-UP HITCH—U385

(Optional on 990 Tractor)

FITTING INSTRUCTIONS

Remove the two bolts attaching the levelling levers to the ramshaft arms and replace these with the two 4½ in. long bolts supplied, using these bolts to attach the two extensions A Fig 22 on to the inside of the ramshaft arms.

Remove the drawbar, allowing the frame to remain in situ, and disconnect the check chain from the left-hand lower link. Shorten both levelling levers to the minimum length position then re-connect

page 30

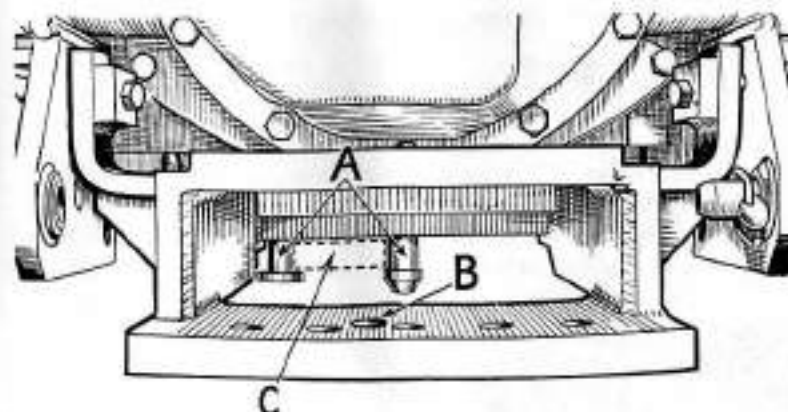

FIG 20. Universal Drawbar Stowing
A. Guide Pins. B. Fixing Hole.
C. Position of Drawbar.

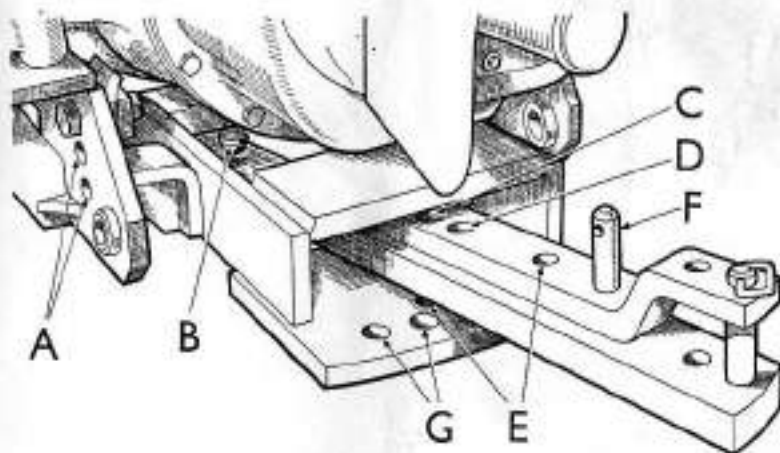

FIG. 21. Universal Drawbar

- A. Height Adjustment Holes.
- B. Front Securing Pin.
- C. Normal Towing Securing Hole.
- D. Swinging Position Pin Hole.
- E. Stowed Position Securing Holes.
- F. Check Chain Pillar.
- G. Off-set Securing Holes.

page 31

the check chains after shortening the chain by wrapping a full turn round the link.

The levelling levers and lower links may be removed if required, but if retained the check chains must be shortened as described, otherwise the lower links may swing against the wheels.

Fit the two lift rods B, attaching their upper ends to the ramshaft arm extensions and removing the drawbar height adjustment pins from the hitch brackets to use for attaching the lower ends of the rods to the two holes in the rear of the drawbar frame.

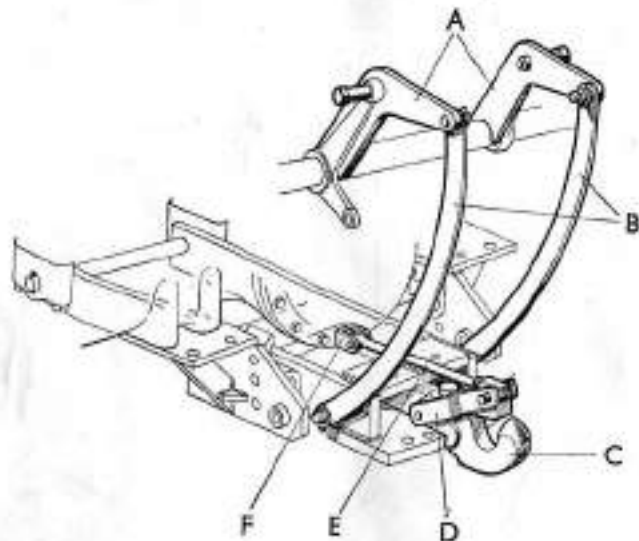

FIG. 22 Pick-up Hitch Assembly—U385

- | | |
|----------------------------|---------------------|
| A. Ramshaft Arm Extensions | D. Locking Jaw |
| B. Lift Rods | E. Locking Jaw Link |
| C. Towing Hook | F. Link Bracket |

PICK-UP HITCH—U462

(Optional on 850 and 880 tractors)

The Pick-up Hitch—U462 must be used in conjunction with the Support Frame—U463 which is used also to support the Universal Drawbar—U461.

page 32

Because of the slotted lift rods it is not necessary to remove the pick-up hitch when it is desired to use the linkages. When the support frame is bolted to the hitch brackets, using holes A Fig. 23, the linkages may be used freely.

FITTING INSTRUCTIONS

If not already fitted, the support frame should be fitted to the tractor by bolting the brackets to the underside of the rear main frame and fitting the hinge bar and split pins.

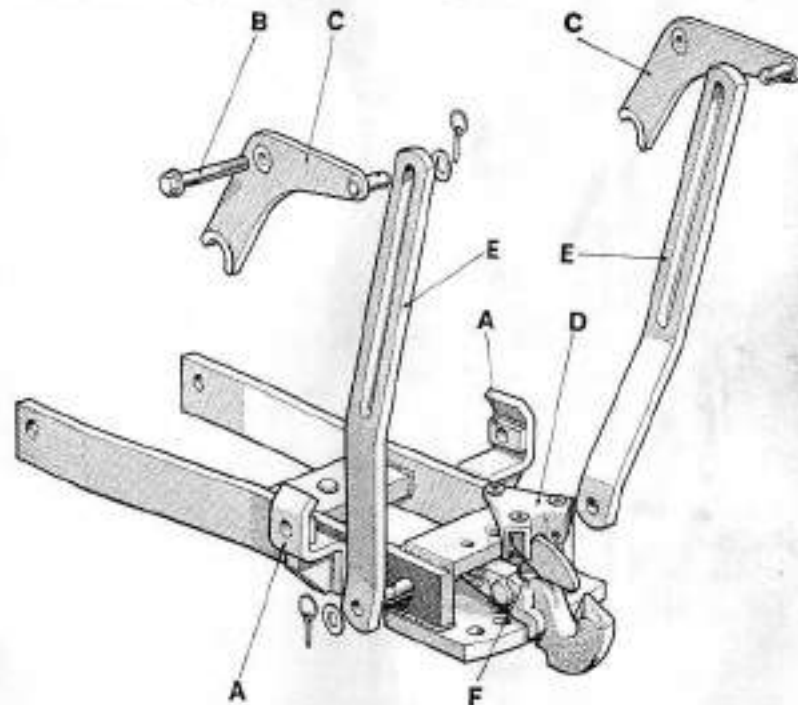

FIG. 23. Pick-up Hitch—U462

- | |
|--|
| A. Securing holes for stowing when not in use. |
| B. Long Securing Bolts. |
| C. Lift Arm Extensions. |
| D. Check Chain Bracket and Hook Retaining Plate. |
| E. Lift Rods. |
| F. Towing Hook Retaining Bolt. |

page 33

Refit the lift rod and levelling lever to the *outside* of the tractor lift arms using the new longer bolts B and fit the lift arm extensions C to the *inside* of the tractor lift arms using the same bolts. Fully tighten these nuts and bolts.

The new check chain bracket D, with the hook retaining plate, should be bolted to the underside of the PTO housing in place of the existing bracket. Transfer the check chains to the new bracket.

Fit the slotted lift rods E. It is important that the washers are fitted before securing with the linch pins.

Bolt the towing hook to the centre hole in the support frame at F. Tighten securely.

Note. The maximum load at the towing hook is 2800 lb. (1270 kg).

PERMANENT DRAWBAR

(Standard on 880, optional on 850 tractor)

This is a light, simple drawbar with two positions, a normal towing position and an extended position to 14 in. (35.6 cm) behind the PTO. The weight limit is 2200 lb (1000 kg) in the forward position and 1200 lb (545 kg) extended.

OVERLOAD RELEASE

When an implement attached to the linkages strikes an obstacle, the impulse from the top link is transmitted through a cable to release the clutch. This stops the tractor and prevents excessive damage to the tractor or implement.

The load at which the clutch is released is set by compressing the spring in the top link by collar A Fig. 24. It should be tightened sufficiently to prevent an excessive number of releases but not so tight that the implement would be damaged before the release operates. Adjust by trial and error, erring on the slack side to begin with and tighten a little at a time until unnecessary releases are just eliminated. The clutch is re-engaged by re-engaging the hand lever B with the latch C after putting the gear into neutral. Negotiate the obstacle before putting the implement to work again.

page 34

Note. Never operate the overload release except from the driving position. To avoid wear on the clutch put the gear lever into neutral and re-engage the overload release as soon as possible if it is desired to keep the engine running.

The overload release only disengages the transmission clutch, but it should never be used to stop the tractor for PTO or belt pulley work. The gear range lever should always be put in neutral when the belt pulley or PTO is being used for stationary work.

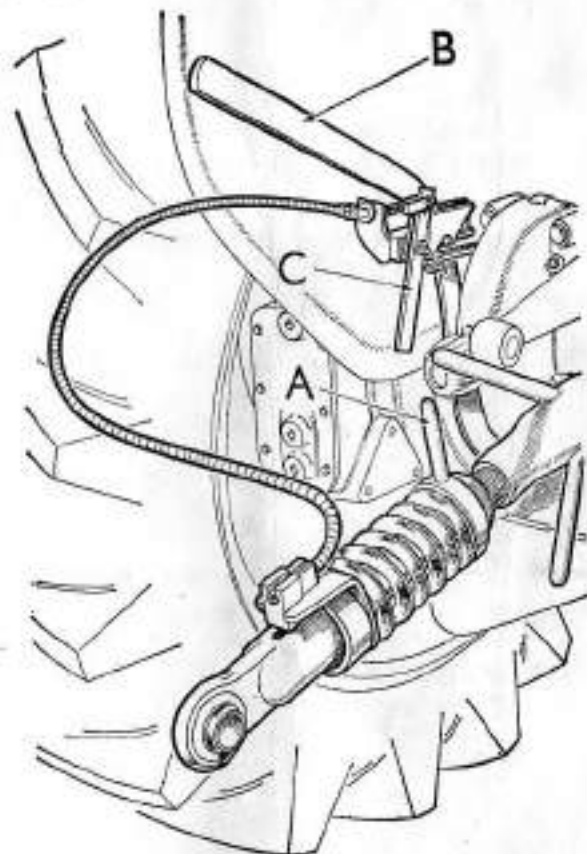

FIG 24. Overload Release

- A Adjustment Collar for setting release pressure.
- B Hand Lever
- C Latch

page 35

MAINTENANCE REMINDER

Regular maintenance of the tractor is an important and essential item affecting the life and efficiency. Full details are given in the **Instruction Book** and these must be followed carefully. It does not take very long to learn how to carry out the routine maintenance but the following will serve as a useful reminder when to do the more important items.

GREASE - - - - - DAILY

Use SAE140 oil for King Pins and the Front Axle Trunion and grease for all other points.

Note. Water pump must only be greased sparingly every 500 hours and only with High Melting Point Grease.

TYRE PRESSURES - AT LEAST ONCE A WEEK

AIR CLEANER - DEPENDS UPON ATMOSPHERIC CONDITIONS - CHECK FREQUENTLY WHEN DUSTY

DRAIN ENGINE SUMP - - - - - 125 HOURS

FIT NEW ENGINE OIL FILTER ELEMENT - - - - - 250 HOURS

INJECTORS - - SERVICE EVERY 500 HOURS

FIRST FUEL FILTER ELEMENT (DIESEL) - RENEW EVERY 500 HOURS

TRANSMISSION - - - - - 1000 HOURS

Note. The transmission should be drained and the MAGNETIC FILTER cleaned every 500 HOURS, the old oil may be used if it is kept clean.

BELT PULLEY - - - - - 1000 HOURS

FINAL REDUCTIONS - - - - - 1000 HOURS

page 36

NARROW TRACTOR WHEEL SETTINGS

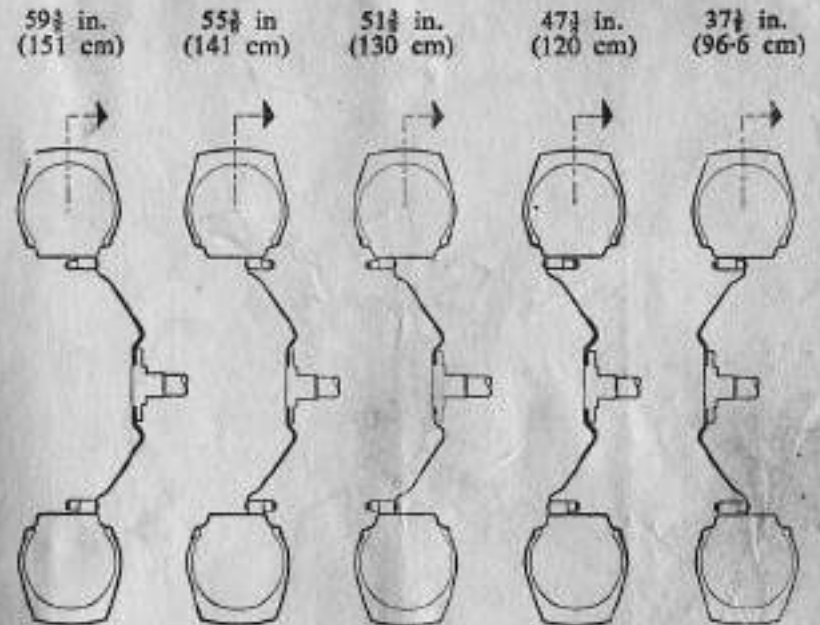

Rear Wheels

FRONT WHEELS

The corresponding front wheel settings are 64 in. (163.5 cm); 60 in. (152.5 cm); 56 in. (142 cm); 52 in. (132 cm); 48 in. (122 cm) and 42 in. (106.5 cm). Referring to Figure 18, the minimum and maximum settings are obtained using bolts A and C. All the intermediate settings use bolts at A and B.

