

2 SERIES OPERATORS MANUAL



REVISION SHEET

REVISION	DATE	PAGE #	CHANGES MADE	CHANGES BY

Loader identification

Below is a quick reference for identifying your Kanga Kid loader, The First letters represent the model of Loader, The next number represents the series of your kanga loader and the last two numbers represent the engine size.

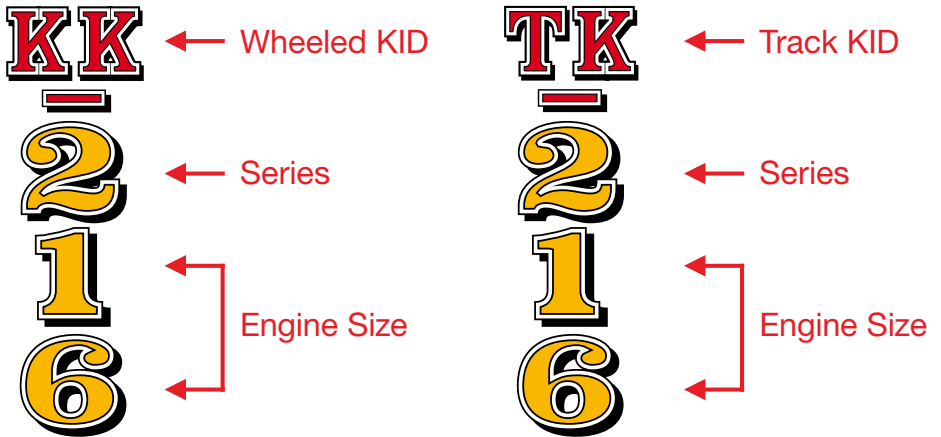

Proprietary Statement

© Copyright 2009 Kanga Loaders Global Pty Ltd. All rights reserved. No part of this publication may be reproduced, photocopied, stored on a retrieval system, or transmitted without the express prior written consent of the publisher.

Disclaimer

While all care has been taken in the development of this product, no loss of any kind is accepted by Kanga Loaders Global Pty Ltd or its agents arising from the use of this document. Kanga Loaders Global Pty Ltd makes no representations or warranties with respect to the contents of this document, and specifically disclaims any express or implied warranties or fitness for any particular purpose. Further, Kanga Loaders Global Pty Ltd reserves the right to revise this publication and to make changes to its contents, at any time, without obligation to notify any person or entity of such revisions or changes.

Trademarks

Kanga Loaders Global PTY LTD (ACN 087 977 660, ABN 14 087 977 660) 2009 (“we”, “us”)

™ Trade mark of Kanga Loaders Global Proprietary Limited.

® Australia Registered trade mark of Kanga Loaders, The Kangaroo Device, Platypus, Kanga Loaders, Kanga Kid, Earth Power.

™ Business on a Trailer, Kanga.

© Digga Loaders Group

1 Copyright

1.1 kanga-loader.com, the material on kanga-loader.com, the software, design, text and graphics comprised in kanga-loader.com and the selection and layout of kanga-loader.com are owned or licensed by us and protected by copyright under the laws of Australia and other countries.

1.2 You may view this website and its contents using your web browser and save an electronic copy of the website solely in the usual operation of your web browser in visiting the site.

1.3 You must not otherwise reproduce, transmit (including broadcast), adapt, distribute, sell, modify or publish or otherwise use any of the material on the site, including audio and video excerpts, except as permitted by statute or with Kanga Loaders prior written consent.

2 Trade Mark Notice

This site includes registered trade marks and trade marks which are the subject of pending applications or which are otherwise protected by law including, but not limited to the word KANGA LOADERS, the Kanga Loaders logo, the Digga Logo. You may not use these trade marks or the names “Kanga Loaders Proprietary Limited”, “Kanga Loaders Australia Proprietary Ltd” or “Kanga Loaders” or the name of any of our related companies.

3 Framing

You must not frame any of the material appearing on kanga-loader.com except in accordance with Kanga Loaders Group’s Linking and Framing Policy or otherwise in accordance with Kanga Loaders group’s prior written consent.

©Digga Loaders Proprietary. All rights reserved.

Patents

Patents Pending US 6397967, 438218 & 10/096997 AU 65424/99, 2006101054

UK 2345046. AU Registered Design 138603

DELIVERY SHEET

Owner:		Date:
Address:		
City:		Post Code:
State/Territory:	Email Address:	
Owners Phone No: ()		Mobile:
Dealer/Delivered By :		
Loader Model and Serial No:		
Attachments:		Serial No.
(1)		
(2)		
(3)		
(4)		
(5)		
Customer's name)		Salesman / Owner to initial
1. Accept delivery of the equipment as detailed above. All equipment has been inspected and is accepted.	<input type="checkbox"/>	<input type="checkbox"/>
2. Have had the operational and safety procedures explained to me for the Loader and attachments and have been provided a copy of these procedures for reference and use.	<input type="checkbox"/>	<input type="checkbox"/>
3. Have received a copy and understand the Operators Manual and safety information contained therein for all equipment and attachments supplied.	<input type="checkbox"/>	<input type="checkbox"/>
4. Understand that I am required to perform a risk assessment/JSEA covering all tasks before I operate this machine and/or any attachment.	<input type="checkbox"/>	<input type="checkbox"/>
5. Understand the warranty conditions and maintenance requirements for the Loader and attachments.	<input type="checkbox"/>	<input type="checkbox"/>
Comments: (COMPLETE SERIAL NUMBER REGISTRATION ON PAGE 8)		
Purchaser's Signature:		Date:
.....	 / /

WARRANTY REGISTRATION CARD

Once you have Read the Warranty section of this Manual please complete the **Warranty Registration Form** below. And check the details then return within 30 days of the delivery date to the address as indicated below the respective country of purchase on the Registration Form.

Owner:	Phone: ()
Address:	Mobile:
Town/City:	Fax: ()
Country:	Post Code:
Delivery Date:	KANGA SERIAL NO:
Email:	
Kanga Agent/Sales Person:	
<p>I (The Purchaser) have read and fully understand the Operator's Manual, Safety Instructions and warranty conditions.</p> <p>Warranty will only be accepted if this Certificate is completed and returned to:</p> <p>AUSTRALIA: KANGA LOADERS, PO Box 6332 Yatala QLD 4207 Email: enquiries@kangaloader.com</p> <p>DEALER STAMP</p> <div style="border: 1px solid black; border-radius: 15px; height: 150px; width: 100%;"></div>	
Purchaser's Signature:	Date: / /

LOADER CHECKLIST

MODEL:	INSPECTOR'S NAME:
SERIAL No.:	MACHINE BUILT BY:
ENGINE No.:	DATE:

VISUAL CHECK ✓ ✗	OPERATIONAL CHECK ✓ ✗
1. Damage.	1. Attachment Plate.
2. Loose bolts/nuts.	2. Throttle Lever (not too tight or loose).
3. Rust.	3. Levers and linkages (Aux Stop Cable adjustment).
4. Leakage oil or water.	4. Unusual noises or vibrations.
5. Wiring / oil cooler connection.	5. Petrol engine Idle 1350-1450rpm.
6. Paint work	6. Petrol engine max 3550-3650rpm.
7. Any untidy weld spots or runs.	7. Is Loader easy to start?
8. Check of fittings alignment.	8. Is Hour Meter working? Test time = hrs.
9. Is Loader clean and tidy?	9. Check that lift cylinder stops in correct position.
10. Are pipes and hoses clear of parts on Loaders?	GUIDANCE ✓ ✗
11. Are Hershel plugs clear of tank & hydraulic lift tubes?	1. Correct stickers applied (UK C/E sticker).
SERVICE ✓ ✗	2. Correct Tyre Pressure sticker attached.
1. Tie down lugs fitted on body.	3. Identification Plate -(correct number stamped).
2. Correct Attachment Plate/ operation ok with test jig.	4. Safety/Operating Manual/DVD.
3. Lubricate Loader, grease all linkages.	5. Track Tool (TK Series).
4. All pins and bushes fitted and tight.	6. Engine Manual (Honda Warranty Form).
5. Wheel condition/wheel nuts been tensioned 100 ft-lb.	FLUID COMPARTMENT CHECK ✓ ✗
6. Is the track slot forward and tyre direction correct?	1. Battery condition.
7. Is the tyre pressure to specification?	2. Engine oil level.
8. Air element and hose clearance and connections tight.	3. Hydraulic oil level.
9. Sediment in fuel filter/tank (drain fuel tank).	4. Fuel level.
10. Is engine EPA compliant?	5. Inspect fuel tanks for leaks.
11. Is PTO direction correct?	6. Hydraulic filter housing directions and elements tight.
12. Has valve tag been removed?	OTHER ✓ ✗
13. Are QRCs correctly aligned and covers fitted?	1. Is the "Passed By" sticker attached and signed?
14. Spare key fitted correctly to machine.	2. Check machine to be shipped against order.
15. Ensure battery is secure and boot is on alternator.	3. Is the Loader ready for despatch?
16. Check oil cooler connection to fan.	4. Have back protection bars been ordered and fitted?.
17. Ensure control knobs are not split and are secured.	5. Beacon operational (Where Fitted).
	6. Light beeper operational (Where Fitted).
	7. Horn beeper operational (Where Fitted).
	8. Reverse beeper operational (Where Fitted).

"Received the above Loader, attachments and documentation as stated above in good condition. The correct operation of the Loader has been explained to our satisfaction. We understand that this Loader should be operated by a properly trained operator. We are aware that the use of this Loader in any manner or place for which it is not designed will render it unsafe."

DISTRIBUTOR'S NAME: _____ INSPECTOR'S SIGNATURE: _____

SERIAL NUMBER REGISTRATION

MAIN COMPONENT SERIAL NUMBERS

KANGA KID

Serial No: _____

Engine Type: _____

Serial No: _____

Wheel Motors:

FRONT RIGHT: _____

REAR RIGHT: _____

FRONT LEFT: _____

REAR LEFT: _____

Lift Ram: _____

Tilt Ram: _____

Hydraulic Pump: _____

Control Valve: _____

Date Purchased: _____

WARRANTY

TERMS AND CONDITIONS

KANGA

- 24 months warranty - Loader chassis against structural fault.
- 12 months/or 1000 hours warranty - All other loader components.

HONDA

- 36 months - Limited engine warranty for motors released after 1/4/10.
- 12 months warranty - Engine accessories (fuel, starter & charging system).

KUBOTA

- 24 months/or 2000 hours - Limited engine warranty.
- 12 months warranty/or 1000 hours - Engine accessories (fuel, starter & charging systems).

Purchaser's Responsibilities:

- The purchaser must ensure maintenance & minor adjustments, as detailed in the Operator's Manual and engine manufacturer's Manual, are carried out as per the schedule. If there is a discrepancy between the two, the Service Chart in the Operator's Manual will take precedence.
- The purchaser must notify Kanga Loaders or an authorized Kanga Loader service representative of the need for warranty repair.
- The purchaser must organise, and is financially responsible for the transport of the product to and from the place of warranty repair.

Product Registration:

The **Purchaser** must fill out and return the warranty registration card within 30 days of purchase in order to validate the warranty.

Repairs

Warranty repairs must be carried out by an **authorized Kanga Dealer**.
(For details contact Kanga Loaders on 07 5546 6399).

Battery Warranty- Pro rata

- One to three months - Free replacement.
- Four to twelve months - Pro rata over 12 months.

Exclusions (No Warranty):

- Normal maintenance, servicing, and replacement items such as spark plugs, oil, oil filters, air filter, muffler, tyres, cutting blades and edges, chains, tracks, cables, etc. are not covered by this warranty.
- Any equipment which has been altered, misused, incorrectly assembled, improperly adjusted, neglected, or damaged by accident is not covered by this warranty.
- Service completed by someone other than an authorized Kanga Loader dealer is not covered by this warranty.
- Any attachment not approved by Kanga Loader or any parts that are not genuine Kanga Loader service parts are not covered by this warranty.
- Engines and engine accessories are covered under the terms of the warranty made by the engine manufacturer, and are not covered by this warranty.

The standard engine manufacturers warranty is for 2 years and is subject to their terms and conditions.

Kanga Loaders may from time to time change the design of its products. Nothing contained in this warranty shall be construed as obligating **Kanga Loaders** to incorporate such changes into previously manufactured products nor shall such changes be construed as an admission that previous designs were defective.

LIMITATION OF REMEDY AND DAMAGES

Kanga Loaders liability under this express warranty, and under any implied warranty that may exist, is limited to repair or replacement of any defective part. In no event shall **Kanga Loaders** be liable for incidental, special, or consequential damages (including lost profits).

DISCLAIMER OF FURTHER WARRANTY

Kanga Loaders makes no warranty other than what is expressly made in this warranty. If the law provides that an implied warranty of merchantability, or an implied warranty of fitness for a particular purpose, applies to **Kanga Loaders**, any such implied warranty is limited to the duration of this express warranty.

SPARE PARTS WARRANTY: 6 MONTHS

TERMS AND CONDITIONS

KANGA LOADERS LTD will warrant any part found to be defective within the conditions of normal usage. Breakage or damage to any part caused by abuse or misuse will not be considered. Hydraulic hoses will not be covered by warranty if any signs of external damage are apparent.

Consumables including tyres, tubes and tracks are not covered by warranty.

The warranty period is for **six (6)** months from the delivery date and applies to only genuine spare parts.

This warranty does not cover any labour, freight, incidental or consequential charges.

The warranty claim will not be recognised without the return of the faulty part to Digga Loaders Ltd and must include the Loader and attachment serial number.

A warranty claim for any engine part is covered by the engine manufactures standard warranty contained in the engine manual handbook.

It is the owner's responsibility to ensure that the correct hydraulic and engine oil levels are maintained and that maintenance is carried out as required in the manuals. Claims for damage as a result of insufficient oil levels will not be recognised.



We thank you for choosing the KANGA KID LOADER. This machine is the result of extensive design and development, and is acknowledged as being a superior product in its category. We congratulate you on your discerning choice and wish you many years of productive service.

Read this manual carefully before operating your machine it contains important technical information, safety precautions and operating instructions. Compliance with Safety Precautions and Risk Management standards together with the correct operation and attention to maintenance procedures are necessary to ensure a long, SAFE and trouble free working life for your KANGA KID LOADER.

Some illustrations in this publication show details or attachments that may be different from your machine. Guards and covers may have been removed for illustrative purposes, however, the machine in its operational state must always be operated with all guards and safety controls in place.

Continuing improvement and advancement of product design may have caused changes to your machine which are not included in this publication. We advise you to read study and understand this manual before undertaking any maintenance, and to keep it with your machine at all times as a ready reference.

SAFETY

The safety section lists basic safety precautions. In addition, this section identifies the text and locations of warning labels used on the machine. Read and understand the basic precautions listed in the safety section before operating or performing lubrication, maintenance and repair on this product.

TABLE OF CONTENTS

WELCOME

REVISION TABLE	3
DELIVERY SHEET	5
WARRANTY REGISTRATION CARDS	6
LOADER CHECKLIST	7
SERIAL NUMBER REGISTRATION	8
WARRANTY DETAILS	9
FOREWARD	11
TABLE OF CONTENTS	12
HOW TO CONTACT US	14

SAFETY

PREPARATION FOR USE	15
SAFETY LABEL IDENTIFICATION	16
SAFE OPERATION	17
FIVE STEPS TO EFFECTIVE JSEA	20
NO GO ZONES FOR UNDERGROUND UTILITY SERVICES	21
OPERATOR SAFETY - summary	22
TASK PLANNING FOR THE KANGA LOADER	23
PRE-OPERATIONAL RISK ASSESSMENT	24
RISK ASSESSMENT	25

OPERATING INSTRUCTIONS

OPERATING INSTRUCTIONS	29
------------------------	----

ATTACHMENTS

HYDRAULIC ATTACHMENT CONNECTIONS	33
4 IN 1 OPERATING INSTRUCTIONS	34
POWER HEAD OPERATING INSTRUCTIONS	35
TRENCHER OPERATING INSTRUCTIONS	36
BUCKET BROOM OPERATING INSTRUCTIONS	37
ROTARY HOE OPERATING INSTRUCTIONS	38
SAFETY - Rules for Attachments	39

TABLE OF CONTENTS

MAINTENANCE

DAILY OPERATOR MAINTENANCE	41
OPERATOR MAINTENANCE – Safety Checks	42
LOADER ARM MAINTENANCE	43
SERVICE TASKS - Instruments	44
SERVICE TASKS - Engine	45
SERVICE TASKS - Hydraulics	46
SERVICE TASKS - Visual	48
SERVICE TASKS - Grease Nipple	48
SERVICE TASKS - Battery	48
SERVICE TASKS - Pivot Pins	49
SERVICE TASK - Tilt Chain	49
SERVICE TASKS - Tyre Pressure	50
SERVICE TASKS - Drive Chain	50
TRACKS - TK 216	51
DECALS	54
SERVICE CHART	55
MAINTENANCE SCHEDULE	56

SPECIFICATION

SPECIFICATIONS - 2 Series	58
DIMENSIONS - 2 Series	59

TROUBLE SHOOTING

TROUBLESHOOTING	60
-----------------	----

HOW TO CONTACT US

SERVICE CENTRES - SPARE PARTS, SERVICE & SUPPORT

QLD SERVICE

Phone: Aus: (07) 3441 9222
Int: +61 7 3441 9200
Fax: Aus: (07) 5546 7922
Int: +61 7 5546 7922
Address: 12 Link Drive
Yatala, QLD 4207

VIC SERVICE

Phone: Aus: (03) 8793 6600
Int: +61 3 8793 6600
Fax: Aus: (03) 9791 6911
Int: +61 3 9791 6911
Address: 85 Cheltenham Road,
Dandenong, VIC 3175

NSW SERVICE

Phone: Aus: (02) 9854 1444
Int: +61 2 9854 1444
Fax: Aus: (02) 9832 7700
Int: +61 2 9832 7700
Address: 1/35 Sterling Road,
Minchinbury, NSW 2770

SOUTHERN NSW AND ACT

Phone: Aus: (02) 6297 9099
Int: +61 2 6297 9099
Fax: Aus: (02) 6297 9199
Int: +61 2 6297 9199
Address: 2/49 Yass Road
Queanbeyan, NSW 2620

SPARES

Email: parts@kangaloader.com

SERVICE BOOKINGS

Email: service@kangaloader.com

VISIT OUR WEBSITE

www.kangaloader.com

DEALER STAMP

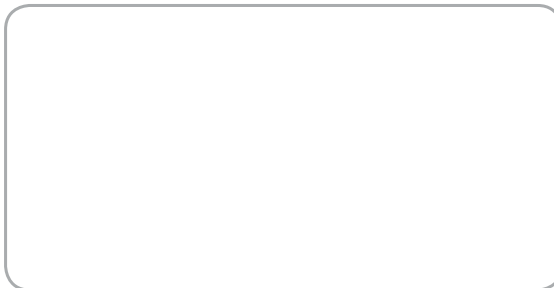

SAFETY

PREPARATION FOR USE

INSPECTION AFTER DELIVERY

When the machine is delivered, it should be inspected for any evidence of damage caused as a result of shipment before it is declared ready for use. The preparation of the mini loader for use should only be undertaken by a responsible person who has read and understood this manual. The requirements are simple and coupled with the use of good common sense, together with general occupational health and safety knowledge and a visual inspection, should not pose any problems. The following checklist provides suggestions for detecting defective or damaged parts.

CHECK BEFORE USE

1	Inspect the machine chassis for any visible damage.
2	Visually inspect all components to ensure they are attached securely.
3	Inspect all areas for evidence of hydraulic oil, engine oil or fuel leakage.
4	Inspect Arm assembly area for firm attachment and sufficient lubrication. Check hydraulic cylinders for oil leakage and visible damage.
5	Check hydraulic oil lines for correct connection and for signs of leakage.
6	Check wheel and tyre assemblies for loose or missing wheel nuts, any visible damage and proper tyre inflation.
7	Check wheel drive motor assemblies for any visible damage and oil leakage.
8	Inspect all cylinders for rust, nicks, scratches or foreign material on shafts. Check for hydraulic oil leaks at the seal and fitting areas.
9	Inspect the engine compartment for loose or missing components and any evidence of damage or leakage.
10	Check the hydraulic fluid level is within operating limits as marked on the Sight Gauge.
11	Check the engine oil level is within operating limits as marked on the Dip Stick.

SAFETY LABEL IDENTIFICATION

The safety section lists safety precautions **required** to be taken when operating or maintaining a Kanga Loader. Read and follow **all** operating and safety instructions contained in this Manual and illustrated on the decals fitted to the Loader, and ensure that you assess the risk of any task by use of the attached Job Safety & Environmental analysis (JSEA) sheet.

If you are unable to identify hazards or do not understand the process for use of the JSEA chart, stop the job and consult a qualified Occupational Health and Safety consultant.

DANGER

THIS SYMBOL HAS BEEN USED THROUGHOUT THIS MANUAL TO HIGHLIGHT CRITICAL SAFETY INFORMATION TO PREVENT DEATH AND INJURY.



THIS SYMBOL HAS BEEN USED THROUGHOUT THIS MANUAL TO HIGHLIGHT IMPORTANT SAFETY INFORMATION. ENSURE YOU READ AND UNDERSTAND THE INFORMATION BEFORE EMBARKING ON ANY RELATED TASK.



THESE SYMBOLS ARE PICTOGRAMS AND REFER TO COMPULSORY PERSONAL PROTECTIVE EQUIPMENT (PPE) THAT MUST BE WORN AND/OR ACTIONS THAT MUST BE TAKEN BY THE OPERATOR TO ALLOW SAFE OPERATION OF THE MACHINE TO OCCUR.

SAFE OPERATION

The Kanga Kid is a versatile machine, capable of performing a variety of tasks in a safe and effective manner, when used in accordance with established procedures and supported by Risk Assessment. However, to ensure the safety of operators and others, it is important to ensure that the capacity of the machine is not exceeded and that the Loader is operated appropriately, and only after all tasks associated with the work at hand have been documented and the relevant risk control measures implemented.

To ensure the safe operation and transport of your Kanga Kid Loader, the following basic Safety Rules must be understood and complied with at all times.

Safe Loading/Unloading and Transportation:

- When loading/unloading the Kanga Kid from a trailer, it is important that the trailer remains attached to the towing vehicle on a firm even surface.
- Never unload a trailer positioned on a slope.
- Ensure the angle of ascent/descent is within safe operational limitations.
- Ensure bystanders are sufficiently clear.
- All loading/unloading is to be carried out at a slow speed with due care for personal safety and damage to equipment. Practice the manoeuvres first on flat ground if necessary.
- When lifting the machine, use appropriately rated slings and shackles and attach securely to the lifting point on the top of the machine.



CAUTION: The Lifting eye MUST be fully seated into the thread before attempting to lift the machine

- Always use the tie down points on each side of the machine to secure the Loader when transporting.
- Always use witches hats, signage and traffic signals to control the unloading/loading zone, particularly when in close proximity to operational roads.

Before Commencing Work:

- Ensure all safety instructions are clearly understood, that operating manuals have been read and that operators are familiar with the controls of the Kanga Kid.
- Ensure that the daily inspection routine has been successfully conducted. It is particularly important to ensure that all attachment Locking Pins are fully engaged and secure.
- Ensure the driving platform is free from dirt, grease or mud before use.
- Check all controls for proper response. Shut down the machine if a fault is detected, tag the machine out with an 'Out of Service' tag, remove the key and contact the local Service Agent.
- Review the working site for hazards through the use of a Job Safety Analysis and/or Risk Assessment and implement the risk control measures to eliminate or minimise their effects, such as:
 - Overhead power lines.
 - Underground services.
 - Excavations.
 - Slopes or adverse cambers.
 - Confined spaces.
 - Other obstructions.
 - Other people or animals accessing the working area or machine.

ALWAYS

- Completely read and understand the Operator's Manual supplied with the machine.
- Undertake a Job Safety and Environmental Analysis (JSEA) and/or Risk Assessment before any use of both the Kanga Loader and the trailer upon which the Loader and/or attachments are carried. A blank JSEA is provided in Appendix A for use. Photocopy as required.
- Use the Job Safety and Environmental Analysis Checklist to check that the relevant safety procedures are in place before work commences.
- Position the trailer carrying the Kanga in an area free from traffic, establish a traffic control plan/zone, chock the wheels and ensure that people are not placed in a position where they can be struck by vehicles or equipment being loaded or unloaded.
- Demarcate the work area with barricades and/or witches hats before using the Kanga Loader.
- Identify, mark and delineate **all** underground services before any work commences.
- Have both feet planted firmly on the driving platform at all times when operating the Kanga Kid. This is especially important when carrying loads, as body weight provides additional counter-balance to the bucket load.
- Come to a complete stop before changing direction from forward to reverse and vice versa. Failure to do so can affect the stability of the Loader and may also damage the drive of your machine.
- Come to a complete stop before operating other hydraulic controls.
- Reverse down slopes at slow speed when carrying loads.
- Ensure the machine is fully stopped and turned off before alighting or exiting the machine. Never use control levers as hand holds, instead utilize the handholds, using the thumbs and forefingers to operate the control levers.
- Travel at speeds suitable for the conditions and as determined by the task JSEA or Risk Assessment.
- When traveling over undulating surfaces and/or rough terrain, it is essential that the operator ensures that the speed is appropriate to suit conditions and to creep over uneven terrain at minimum speed. The recommended normal operating speed is between 2/3 to 3/4 throttle; at a lower speed the noise levels are reduced to both the operator and bystanders.
- Wear approved, appropriate Personal Protective Equipment (**PPE**), such as:
 - hearing protection.
 - safety footwear.
 - eye protection.
 - hard hat.
 - long, close fitting protective clothing.
 - a high visibility vest or clothing etc.
- Keep hands, feet and clothing away from all moving parts, including hydraulic rams.
- Keep body parts within the confines of the machine.
- Keep alert, and avoid being distracted whilst operating the loader.
- Remove the key and chock the wheels whenever the Loader is to be left unattended and/or unsupervised.



NEVER

- Operate this machine or the trailer without undertaking a Risk Assessment or JSEA.
- Operate this machine without Personal Protective Equipment (PPE).
- Exceed the Safe Working Load (SWL) of 100kg (220lbs) for the Kanga Kid.
- Carry passengers on any part of the Loader or attachments.
- Place feet under the driving platform.
- Smoke (or approach the Loader with a naked flame) whilst operating or refuelling.
- Leave the engine running whilst refuelling.
- Tie or secure yourself to any part of the machine or attachment.
- Fool around while operating the Loader or attachments.
- Carry a load with the bucket raised. Carry all loads as close to the ground as practicable.
- Traverse across slopes, especially on uneven ground.
- Jerk the control levers. Always use a steady, even action to achieve proper control.
- Touch exhaust, engine parts, hydraulic pipes and fittings, drive chains, friction parts or guards.
- Park or leave Loader unattended on a slope.
- Remove safety decals.
- Remove safety guarding.
- During operation use mobile telephones or portable radios.
- Operate machine for extended periods at full throttle.



CAUTION

Always exercise care when operating on slopes. The Kanga Kid Loader has been designed to be able to access restricted areas, due to its minimal width. This, however, reduces its stability when crossing slopes.

The Kanga Kid Loader is designed to operate on slopes to a maximum of 15°, under no circumstance is this to be exceeded. The actual safe slope angle may need to be reduced depending on a number of variables, such as site conditions, attachments, condition and configuration of machine and operator experience.

Crossing slopes should be avoided wherever possible. If it is not possible, slopes should be traversed with loads lowered as far as possible, reduced speed and extreme caution.

FIVE STEPS TO EFFECTIVE JSEA

1	DOCUMENT THE ACTIVITY Assemble those involved in the activity and then, using the JSEA worksheet, write down in step by step form, the tasks that make up the activity.
2	IDENTIFY THE HAZARDS Next to each task, identify what part of the task may cause injury to those engaged in the task or others in the vicinity.
3	DOCUMENT THE CONTROL MEASURES For each identified hazard, assess the associated level of risk to those involved, and then list the control measures required to eliminate or minimise those risks.
4	IDENTIFY WHO IS RESPONSIBLE Document the name of the person responsible for implementing the control measure.
5	MONITOR AND REVIEW Ensure that the activity is supervised and that the documented process is being followed. The documentation should be reviewed whenever a documented activity changes or when there is a change of personnel or after an appropriate length of time.

NO GO ZONES FOR UNDERGROUND UTILITY SERVICES

No work is to commence on any worksite until you have checked if it contains underground services. Here is how you can find out.

- The “Dial Before You Dig” service (in Australia, **dial 1100**, provides free and easy access to the records of a large number of organizations, including telecommunications, water, electricity and gas.
- To see a list of organizations registered with the service or to log an enquiry electronically, visit the Dial Before You Dig website at www.dialbeforeyoudig.com.au, or telephone 1100 (otherwise consult with your local environment department).

If underground services are present, you must comply with the No Go Zones.

If the worksite contains or is suspected to contain ANY underground services, before any work commences, you must follow the relevant No Go Zone safety procedures:

- No Go Zone safety procedures are available from all gas, water, telecommunications, and electricity companies.
- You must follow these safe systems of work at all times. If you cannot comply with these safety procedures, then NO work shall be undertaken without written permission being received from the utility company.
- The Kanga Kid and attachments must be kept a minimum distance of 2 meters from all underground services.

MAINTAIN A MINIMUM OF 2 METERS DISTANCE FROM ANY UNDERGROUND SERVICE.



OPERATOR SAFETY - SUMMARY



1. READ OPERATORS MANUAL PRIOR TO USE



2. DAILY INSPECTION

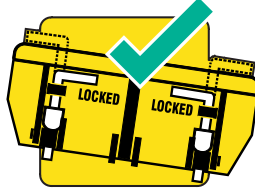

3. ENSURE BOTH (2) ATTACHMENT LOCK PINS ARE FULLY ENGAGED

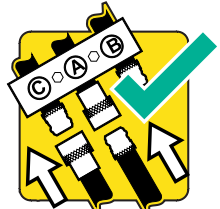

4. ENSURE HYDRAULIC HOSES ARE CLEAN AND ATTACHED

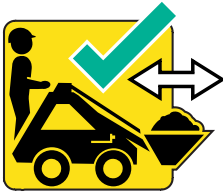

5. TRANSPORT MATERIAL WITH BUCKET DOWN AND LEVEL

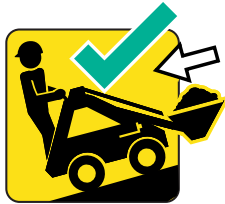

6. ALWAYS REVERSE DOWN SLOPES



7. WEAR APPROPRIATE PROTECTION

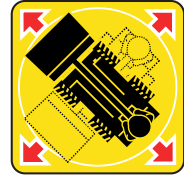

8. NO PERSONNEL WITHIN A 4M (12 ft.) DIAMETER



9. NO SMOKING WHILE FILLING



10. DO NOT PLACE FEET UNDER STANDING PLATFORM



11. DO NOT TRAVEL WITH ARMS RAISED



12. AVOID TRAVELLING ACROSS SLOPES



13. NO PERSONNEL IN BUCKET OR ATTACHMENTS



14. PAY ATTENTION



15. OPTIMUM OPERATION OF THIS MACHINE IS ACHIEVED AT 2/3 TO 3/4 THROTTLE

DANGER

FAILURE TO READ THESE SAFETY RULES PRIOR TO ANY MACHINE OPERATIONS MAY LEAD TO SERIOUS INJURY, PROPERTY DAMAGE OR DEATH.

TASK PLANNING & SAFETY CONSIDERATIONS

PERFORM A SITE ASSESSMENT

Is the terrain stable or suitable to work on?

- Unload Loader from a trailer with ramps.
- Conduct a thorough site inspection before entering site with Loader.
- Consider wet or boggy conditions.
- Consider environmental factors.
- Consider steep slopes. Do not work side on to slopes.
- Dial before you dig (dial 1100) to check for services.
- Amend your plans and take precautions where necessary.
- Document your plans in the JSA/SWMS.

Personal safety

- Where other mobile plant and equipment is in use, wear high visibility garments.
- Read the Loader instruction manual – familiarise yourself with Loader features.
- Use Loader only as specified in instruction manual.
- Perform a pre-operational inspection of the Loader to identify any faults.
- Ensure all safety features are operable.
- Use bunting, flags or witches hats to demarcate or isolate work area.
- Wear additional PPE such as safety glasses, hearing protection and hard hat and steel capped boots.

Task execution

- Discuss work plans with other workers/persons in the area.
- Coordinate Loader activities with other trades/activities on site.
- Work in a logical sequence.
- Do not exceed weight/load and operational limitations of the Loader.
- Keep loads low to the ground when travelling.
- Keep bucket down when not in use.

Site Clean Up

- Remove Loader from site.
- Wash Loader down and inspect Loader for hydraulic leaks/damage.
- Return Loader and attachments to trailer.
- Remove bunting, flags, witches hats.
- Restore site conditions as required.

Perform a site assessment

ENGAGE YOUR MIND BEFORE USING THE LOADER

Assess the risks

STEP BACK - Take 5 X 5

Take 5 steps back

Take 5 minutes to reflect

- **Stop and think.**
- **Observe the work area and surroundings.**
- **Step through your mind what you are going to do.**
- **Think about what else is happening in the area or nearby.**
- **Identify what else could go wrong.**
- **Decide on control measures to prevent things going wrong.**
- **Make sure the hazards are controlled before starting work.**

Think about the consequences to your quality of life, your income, your family, your children and everything you value. Are these things worth the risk of rushing or cutting corners? It's not just your life that could be affected – you may shatter the lives of the ones you hold dear.

THINK SAFE ! ACT SAFE ! BE SAFE ! GO HOME

OHS&E Risk Assessment/SWMS – Powered Mobile Plant

Work Activity	
Principal Contractor's Name:	Project Reference #:
Contractor Name:	ABN:
Contractor Address:	Foreman and contact number:
Prepared By:	
Name 1: Signature: Position:	Name 2: Signature: Position:
Received and reviewed by:	
Name: Signature: Position:	Date:
Date work method prepared: (must be within last 12 months)	
Actions before work commences: (e.g. signage, bunting, demarcation, isolation)	
Action during work:	
Actions after work is complete:	

Supervision:	Engineering details/certificates/ authority approval required:
Personnel qualification & experience required:	Permits e.g. excavation, hot work etc:
Training and instruction:	Warning signs and control measures:
Plant, equipment & materials to be used and the maintenance checks to be completed (details at back of SWMS also): Loader	Personal protective equipment requirements:
Legislation, codes of practice, standards applicable:	List of attachments (e.g. material safety data sheets, diagrams etc):

RISK SIGNIFICANCE (Level of Risk)

C = Consequence	L = Likelihood	Risk control legend
5 = Catastrophic Death, disablement, significant incident, unacceptable risk, significant financial cost.	5 = Almost Certain Could occur in most circumstances	16-25 Cease activity immediately and implement risk controls before commencing work activities. Make the work area safe & consult with competent/qualified personnel. 10-15 Plan and implement risk control measures after performing a Step Back 5 X 5 risk assessment. Seek advice from the manufacturer if any doubt exists. 6-9 No immediate risk. Assess overall risk in line with resources, instruction manual, and manufacturer's advice. 1-4 Accept level of risk
4 = Major Extensive injuries leading to lost time, major risk-damage to plant and equipment, major financial cost for repairs/reinstatement.	4 = Likely May probably occur in most circumstances	
3 = Moderate Medical treatment, medium risk-damage to plant and equipment, medium financial cost for repairs/reinstatement.	3 = Possible May occur at some time	
2 = Minor First Aid treatment, minor risk-damage to plant and equipment, minor financial cost for repairs/reinstatement.	2 = Unlikely Could occur at some time	
1 = Insignificant: No injuries, slight damage, low financial cost for repairs/reinstatement.	1 = Rare May occur only in exceptional circumstances	

Likelihood (L)	Consequences (C)					1
	5 Catastrophic	4 Major	3 Moderate	2 Minor	1 Insignificant	
5 – Almost Certain	25	20	15	10	5	
4 – Likely	20	16	12	9	4	
3 – Possible	15	12	9	6	3	
2 – Unlikely	10	8	6	4	2	
1 – Rare	5	4	3	2	1	

ITEM #	WHAT ARE THE BASIC STEPS (List steps in logical sequence & include materials, equipment etc)	POTENTIAL HAZARDS (What may cause an injury/illness to occur)	RAW RISK RANKING L C R	HAZARD CONTROLS (What controls will be put in place to prevent an injury/illness) N.B. Control measures must not raise or create an increased risk	RESIDUAL RISK RANKING L C R	WHO WILL MONITOR & ENSURE THAT THIS IS DONE

OPERATING INSTRUCTIONS

BEFORE STARTING

Check the fuel level and fill up if necessary. Ensure that the fuel is the correct type, free from impurities or water. Check that both the crankcase oil and hydraulic oil levels are within operating limits.



CAUTION: Check that all control levers below are in the neutral centre position.

STARTING

Refer to the engine manual for correct throttle (6) starting positions in warm and cold conditions. Turn starter key switch to start engine.



CAUTION: Do not move any of the control levers unless standing with both feet on the driving platform and holding the grip handles, ensuring non-operating personnel are clear of the Loader.



CAUTION: First time users to use slow 1/3 throttle to practice safe operation before commencing work. The recommended normal operating speed of the machine is 2/3 to 3/4 Throttle.



CAUTION: The Kanga Kid is not fitted with a “seat belt”. The standing position is a safety feature which allows a quick exit from the machine in case of an emergency. Do not add a restriction system to the machine which will limit your ability to safely exit from the Kid Loader.



CAUTION: Always exercise care when operating on slopes. The Kanga Kid Loader is approximately 0.08 meter (31.5”) wide, which is a great benefit for providing access to confined spaces, however, the machine may become unstable if operating across a slope. If it is impossible to avoid crossing a slope keep the load close to the ground and travel at reduced speed.

The maximum safe angle of slope is 15°. This angle is a recommendation only. The actual safe slope angle will depend on site conditions, operator experience and activity.

CONTROLS

On the top face of the KANGA KID Loader are five spring centered levers which control the basic functions. The table below indicates the levers with their corresponding functions:



LEVER	PUSH	PULL
1	Lowers Arm	Raises Arm
2	Aux. Motor Reverse	Aux. Motor Forward
3	Left Drive Forward	Left Drive Reverse
4	Right Drive Forward	Right Drive Forward
5	Tilt Forward	Tilt Backward
6	Throttle Faster (Start)	Slower



CAUTION: Do not move any of the control levers unless standing with both feet on the driving platform and holding the grip handles, ensuring non-operating personnel are clear of the Loader.

MANOEUVERING

The forward and reverse levers should be thought of as softly operated clutches for engaging and disengaging the wheels. Use slow even movements of the control levers for smooth operation of the Loader. Practice slow starts and gentle stops in an open, safe area.

Manoeuvring is made possible by individual controls for the hydraulic motors on each side of the machine. A turn may be achieved by varying the amount and/or direction of power supplied to each side of the machine. The machine is capable of turning in its own length by applying equal forward and reverse power to opposite sides of the machine.

While moving forward, a gentle turn to the left for instance, can be made by slightly increasing the power to the right hand side or by reducing the power to the left hand side of the machine. This mode of steering allows the type of turn to be chosen to suit the situation.

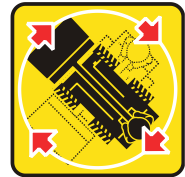

MANOEUVRING

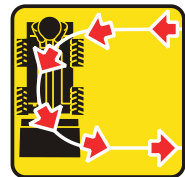

MANOEUVRING



CAUTION: Always ensure that the attachment Locking Lugs are fully engaged at all times.

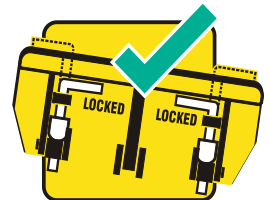

3. ENSURE BOTH (2) ATTACHMENT LOCK PINS ARE FULLY ENGAGED

PARKING AND SHUTDOWN

When parking the Kanga always select level ground and lower any bucket or attachment fitted fully to the ground. To shut down, reduce the engine speed to idle and turn the key to the off position. Remove the key to prevent unauthorized use.

- When loading/unloading the Kanga from the trailer, it is important that the trailer remains attached to the towing vehicle on a firm even surface.
- Do not unload a trailer on a slope.
- Ensure bystanders are sufficiently clear.
- All loading/unloading to be carried out using a ramp must be done at a slow speed, with due care for personal safety and damage to equipment. Practice the manoeuvres first on flat ground if necessary.



CAUTION: Lifting eye MUST be fully seated before attempting to lift the loader.



- Use appropriately rated slings and shackles, and attach to the lifting point on the top of the machine when lifting the machine.
- Always use the tie down points on each side of the machine to secure the Loader when transporting.
- Always use witches hats, signage and traffic signals to control the unloading/loading zone, particularly when in close proximity to operational roads.



CAUTION: Do not park or leave the machine on steep slopes.

**ONLY KANGA KID DESIGNED AND APPROVED
ATTACHMENTS ARE TO BE USED ON
THIS MACHINE.**

“No other attachment is to be used on this machine unless the design and use of the attachment has been assessed and authorised by Kanga; and has been supported by a compliant Risk Assessment, which has been verified and validated by the Risk Management Consultants.”



ATTACHMENT CONNECTIONS

Kanga Kid Loaders are fitted with hydraulic quick release couplings (QRC) to connect the different attachments. The QRCs are paired as male and female to ensure correct hose connections.



**3/8' Male QRC -
Male Cover -
3/8' Female QRC
Female Cover**

**Part Number # L119941
Part Number # L119971
Part Number # L119961
Part Number # L119951**

4 IN 1 OPERATING INSTRUCTIONS

SAFE AND EFFICIENT USE OF BUCKETS

When lifting soil from a heap or pile, always have the bucket level. To achieve this, push the Loader arm downwards and use the tilt ram to bring the bucket level with the ground.



Towards the end of the run when the bucket is nearly full, gently tilt the bucket (rotate the bucket) towards the Loader. This decreases the lifting resistance when the arms are raised and promotes an efficient tear out.

When transporting material in the bucket on slopes or rough ground, always keep the bucket close to ground level. This lowers the centre of gravity of the Loader and maximises stability.



The material may then be dumped into a trailer or utility truck for removal or repositioning on the site.

When scraping, levelling and surface stripping, lower the bucket to the ground, tilt it down and so raise the front wheels slightly off the ground. Drive forward using the back wheels, the bucket will bite into the soil as you move forward.



CAUTION: Do not step off the operator platform with the load raised or the machine moving.



CAUTION: Always ensure that the attachment Locking Pins are fully engaged at all times.



1. READ OPERATORS MANUAL PRIOR TO USE



6. ALWAYS REVERSE DOWN SLOPES WITH LOAD



13. NO PERSONNEL IN BUCKET OR ATTACHMENTS



12. AVOID TRAVELLING ACROSS SLOPES



10. DO NOT PLACE FEET UNDER STANDING PLATFORM



14. PAY ATTENTION

POWER HEAD OPERATING INSTRUCTIONS

FITTING OF POWER HEAD:

Drive the Loader to the attachment and couple the attachment plate onto the attachment. Raise the Power Head slightly and engage the locking Lugs fully. Turn the engine off and push the AUX Control Lever forwards and backwards to release any hydraulic line pressure. Clean the hydraulic fittings (QRCs) and then connect them to connections (see “Attachment Connections” section).

Removal procedure is the reverse order of the above. Remember to always reconnect the attachment hoses into one another to stop dirt entering the hydraulic system, or fit the dust caps supplied.

FITTING THE AUGER

Once fitted to the Loader, raise the Power Head high enough to allow the auger to be positioned into the Power Head’s round drive shaft. Drive the Power Head forward positioning the drive into the auger, aligning the locking pin holes.



CAUTION: Large auger fitting is a 2 person operation.

PRE - OPERATION CHECK

Ensure that the Power Head is securely attached to the Kanga Kid Check that the couplings are engaged and check for leaks. Tighten/repair as required.



CAUTION: Prior to commencing work, read the **Safety Rules** of this Kanga Loader Manual.

Inspect the cutting tips and teeth. Ensure that they are in good condition and firmly attached.

Note: *Teeth should display slight movement. Check that bolts securing the pilot are tight.*

OPERATING INSTRUCTIONS:

Start the auger turning in a clockwise direction by activating the “AUX” lever downwards. Lower the auger by pushing the “ARM” lever forward. If the ground is hard the front wheels of the Kanga Loader will lift off the ground. As the auger cuts into the ground the arc of the arm travel will move it out of vertical. To keep the auger vertical, move the Kanga Loader backward or forward slightly to compensate. Continually clear the hole during digging by raising the auger up (pull back on the “ARM” lever).

Drill a “trial” hole in a clear area to practice all operations and to become familiar with the procedure.



CAUTION: Prior to commencing any digging operations, check with the Local Authorities and the land owner that there are no buried services (Power, phone, water, gas, sewage etc) in the vicinity. **Australia ONLY:** Phone 1100 “DIAL BEFORE YOU DIG”

Read the Safety instructions in this Manual.

Keep clear of the auger at all times (4m minimum).

TRENCHER OPERATING INSTRUCTIONS

FITTING A TRENCHER

Drive the Loader to the attachment and couple the Attachment Plate onto the attachment. Raise the Trencher slightly and engage the locking lugs fully. Turn the engine off and push the AUX Control Lever forwards and backwards to release any hydraulic line pressure. Clean the hydraulic fittings (QRCs) and then connect them to connections (see “Hydraulics General Description” section). Removal procedure is the reverse order of the above. Remember to always reconnect the attachment hoses into one another to stop dirt entering the hydraulic system, or fit the dust caps supplied.

PRE-OPERATION CHECK

Ensure that the Trencher is securely attached to the Kanga Loader. Check that the couplings are engaged and check all joints for leaks. Tighten/repair as required. Inspect the cutting teeth, ensuring that they are in good condition and firmly attached.

Chain Tensioning:

The Trencher chain requires 35-45mm of “lift” to have the correct tension and should be adjust as required. This is achieved by loosening the 16mm bolt, adjusting the adjustment wedge, and retightening the bolt.



CAUTION: Read all safety rules before operating. See Safety chapter in this manual.

OPERATING INSTRUCTION



Position the Trencher, and activate the AUX lever so that the chain runs along the top of the boom and returns back towards you on the underside. Engage the TILT lever so that the boom and chain arcs down to dig a trench. When the desired depth is achieved, slowly drive the Kanga Kid backwards along the trench line.(the Kid machine does not have a trenching valve) to move the machine back using the drive levers in a pattern of pull back release pull back release and so forth letting the Trencher chain clear the trench each time .if you hold the drive levers back in the metering position this will decrease the performance of your trenching and increase the chance of overheating the hydraulic oil. A cooler is available as an optional extra if a lot of trenching is done.

NOTE: Minor adjustments are required to maintain a straight line as the Loader will tend to “drift” to the left.



CAUTION: Prior to commencing any digging operations, check with the Local Authorities and the land owner that there are no buried services (Power, phone, water, gas, sewage etc) in the vicinity.

Australia ONLY: Phone 1100 “DIAL BEFORE YOU DIG”

Read the Safety instructions in this Manual.

Keep clear of the Trencher at all times (4m minimum).

<https://tractormanualz.com/>

BUCKET BROOM OPERATING INSTRUCTIONS

FITTING THE BUCKET BROOM

1. Connect the attachment plate of the loader to the Bucket Broom frame ensure the attachment locking lugs are engaged.
2. Turn the engine off, move the Aux Lever 2 back and forth to release hydraulic pressure. Ensure the QRC's are clean then connect the hoses of the Bucket Broom to the QRC's on the left hand side of the loader when looking from the front of the machine.
3. To Remove the Bucket Broom please reverse the instructions above.



CAUTION: Prior to commencing work, read the **Safety Rules** of this Kanga Kid Loader Manual.

PLEASE NOTE: ALWAYS FIT THE DUST CAPS PROVIDED FOR THE QRC'S TO YOUR ATTACHMENT AND MACHINE WHEN NOT IN USE TO PREVENT DIRT ENTERING THE SYSTEM.

OPERATING INSTRUCTIONS:

1. Ensure Lever 2 is in neutral.
2. Start the Engine and adjust the Engine RPM Lever 6 to suit the operation power you require.
3. Position the Bucket flat on the ground engage Lever 2 and pull towards the operator. This will start the Broom rotating and sweeping into the bucket base.
4. The Bucket can either be pulled or pushed with the mini loader drive system however the does work more efficiently when pulled.
5. Using levers 3 & 4 Drive the machine, Travel Speed is controlled by levers 3 & 4 by gently engaging both levers forward, The further forward they are the faster the machine will travel and slowing down is the exact reverse allowing the levers to gently return to centre will slow the machine down.
6. To empty debris from the bucket disengage Lever 2 tilt back slightly and drive to the location you would like to dump the debris, Raise the lift arm with Lever 1 and tilt the bucket forward to dump the debris out using Lever 5.

ROTARY HOE OPERATING INSTRUCTIONS

FITTING THE ROTARY HOE

1. Connect the attachment plate of the loader to the Rotary Hoe ensure the attachment locking lugs are engaged.
2. Turn the engine off, move the Aux Lever 2 back and forth to release hydraulic pressure. Ensure the QRC's are clean then connect the hoses of the Rotary Hoe to the QRC's on the left hand side of the loader when looking from the front of the machine.
3. To Remove the Rotary Hoe please reverse the instructions above.



CAUTION: Prior to commencing work, read the **Safety Rules** of this Kanga Loader Manual.

PLEASE NOTE: ALWAYS FIT THE DUST CAPS PROVIDED FOR THE QRC'S TO YOUR ATTACHMENT AND MACHINE WHEN NOT IN USE TO PREVENT DIRT ENTERING THE SYSTEM.

PRE - OPERATION CHECK

1. Ensure the Rotary Hoe is securely attached to the Kanga Kid Loader.
2. Check that the couplings are engaged and check all joints for leaks.
3. Tighten and repair and required.
4. Check the rotary hoe and cutting blades are in good condition.

OPERATING INSTRUCTIONS:

1. Ensure Lever 2 is in neutral.
2. Start the Engine and adjust the Engine RPM Lever 6 to suit the operation power you require.
3. Position the Rotary Hoe flat on the ground and engage Lever 2 and pull towards the operator to start the blades rotating.
4. The Rotary Hoe should only be pulled with the mini loader drive system. Using Levers 3 & 4 to drive the machine. Travel Speed is controlled by levers 3 & 4 by gently engaging both levers Rearward, The further Rearward they are the faster the machine will travel and slowing down is the exact reverse allowing the levers to gently return to centre will slow the machine down.
5. The travel speed of the loader will adjust the condition of the soil, slower travel speed will turn the soil over more making it softer. Fast speed will turn the soil over less allowing for a Chunkier texture.

SAFETY - RULES FOR ATTACHMENTS

The following safety requirements should be read in conjunction with the Safety Rules provided for the base model, i.e., Kanga Loader, Kanga Kid, and the corresponding Operating Instructions accordingly. All tasks and risks associated with the activity are identified using the Job Safety and Environmental Analysis (JSEA) or Risk Assessment (RA) and **ALL** risk controls are to be identified and implemented before the work commences.

FORK LIFT TYNES SAFETY RULES

Always...

- Establish and maintain a minimum 4 meter (12 foot) exclusion zone around the local working area and ensure no person other than the operator, enters this zone whilst the machine's engine is running.
- Keep the general working area clear of bystanders and other workers. Loader operations typically rely on rapid movement and direction changes. It is important, therefore, that the whole operation area is kept clear of other personnel and operators maintain vigilance about their immediate surroundings.



FORK LIFT TYNES

Never...

- Place any article or body part under the tynes at any time.
- Carry passengers, either on the machine or on the tynes of the forklift.
- Overload the machine or tynes.
- Travel with the tynes raised, especially when carrying loads.

ANGLED BACK-FILL BLADE SAFETY RULES

Always...

- Establish and maintain a minimum 4 meter (12 foot) exclusion zone around the local working area and ensure no person other than the operator, enters this zone whilst the machine's engine is running.
- Keep the general working area clear of bystanders and other workers. Loader operations typically rely on rapid movement and direction changes. It is important, therefore, that the whole operational area is kept clear of other personnel and operators maintain vigilance about their immediate surroundings.



BACK FILL BLADE

Never...

- Place any article or body part under or near the angled back-fill blade at any time.

4 IN 1 BUCKET SAFETY RULES

Always...

- Establish and maintain a minimum 4 meter (12 foot) exclusion zone around the local working area and ensure no person other than the operator, enters this zone whilst the machine's engine is running.
- Keep the general working area clear of bystanders and other workers. Loader operations typically rely on rapid movement and direction changes. It is important, therefore, that the whole operation area is kept clear of other personnel and operators maintain vigilance about their immediate surroundings.
- Check with Local Authorities and land owners about the presence of underground services within the prospective working area prior to commencement of work. (Dial **1100** to establish any existing underground services before work commences.)
- Ensure excavations are located a minimum of 2 meters away from any underground service.



FOUR IN ONE BUCKET

Never...

- Place any article or body part between the jaws of an open bucket, or under the bucket at any time.

TRENCHER SAFETY RULES

Always...

- Establish and maintain a minimum 4 meter (12 foot) exclusion zone around the local working area and ensure no person other than the operator, enters this zone whilst the machine's engine is running.
- Check with Local Authorities and land owners about the presence of underground services within the prospective working area prior to commencement of work. (Dial **1100** to establish any existing underground services before work commences.)
- Ensure trenches are located a minimum of 2 meters away from any underground service.

Never...

- Place any article or body part under the trencher at any time

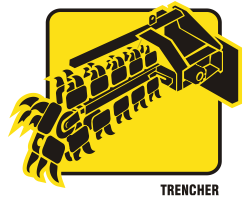

POST HOLE AUGER & TREE PLANTER AUGER SAFETY RULES

Always...

- Establish and maintain a minimum 4 meter (12 foot) exclusion zone around the local working area and ensure no person other than the operator, enters this zone whilst the machine's engine is running.
- Check with Local Authorities and land owners about the presence of underground services within the prospective working area prior to commencement of work. (Dial **1100** to establish any existing underground services before work commences.)
- Ensure excavations are located a minimum of 2 meters away from any underground service.

Never...

- Place any article or body part under the auger at any time



ROTARY HOE (TILLER) SAFETY RULES

Always...

- Establish and maintain a minimum 4 meter (12 foot) exclusion zone around the local working area and ensure no person other than the operator, enters this zone whilst the machine's engine is running.

Never...

- Place any article or body part near or under the Rotary Hoe at any time.
- Carry out maintenance of any type whilst the Rotary Hoe is attached to the Loader or any other power source.



BUCKET BROOM SAFETY RULES

Always...

- Establish and maintain a minimum 4 meter (12 foot) exclusion zone around the local working area and ensure no person other than the operator, enters this zone whilst the machine's engine is running.
- Keep the general working area clear of bystanders and other workers. Loader operations typically rely on rapid movement and direction changes. It is important, therefore, that the whole operation area is kept clear of other personnel and operators maintain vigilance about their immediate surroundings.
- Wear respiratory and eye protection whilst using the Bucket Broom.

Never...

- Place any body part under the bucket broom at any time.



DAILY OPERATOR MAINTENANCE

INSPECTION AND CHECKS

Before each day's operation of the Kanga Kid Loader, the operator **MUST** perform the inspection and checks as outlined below.

The purpose of the operator's inspection is to keep the equipment in a safe working condition and to detect any signs of malfunctioning during normal operations between scheduled maintenance checks.

While it may not be the operator's responsibility to perform mechanical maintenance, they should be thoroughly familiar with the unit, as this involves their own safety.

Many costly maintenance jobs can be prevented through observance of the following operator maintenance inspections and checks by Kanga Kid Loader operators.

For expert advice and quality service, consult an expert repairer, we recommend an authorised kanga repairer.

The owner should retain evidence that proper maintenance has been performed as prescribed.

A claim against a warranty will not qualify if it results from lack of maintenance and not from defective material or authorised workmanship.



CAUTION: DO NOT operate a Kanga Kid Loader that is known to be damaged or malfunctioning. Remove the key from the ignition and Tag Out the machine using an Out of Service tag and contact your Service Agent.

Defective components and/or equipment malfunctions can jeopardise the safety of the operator and other personnel and can cause extensive damage to the unit. Remember, a poorly maintained unit could become a great operational hazard.

DAILY CHECKS

Element		Yes	No	Comment
LOADER				
Tyres & Whee	Good condition/ adequate tread.			
	Adequate pressure.			
	Wheel nuts secure.			
Guarding	Good condition.			
	Secure.			
Hydraulics	Good condition of hoses (check for leaks).			
	Good condition of casings (check for leaks).			
	Good condition of rams (check for leaks).			
	Adequate hydraulic oil level.			
Controls	Correct operation.			
	Responsiveness.			
Structure	Adequate weld condition.			
	Free of cracks/damage.			
	Linkage Pins greased.			
Bolts and Fasteners	Check pivot pins for wear/damage.			
	Tight.			
	None missing or damaged.			
Battery	Terminals tight.			
	Free of corrosion.			
	Good condition (check indicator).			
Safety Decals	Legible.			
	All in place.			
Engine	Adequate crankcase oil level.			
	Check Air cleaner / Filter.			
Fuel	No Leakage.			
	Adquate Fuel Level.			
	Drain water tap if fitted (Optional Extra).			
Operating Manual	Present with machine.			
ATTACHMENT				
Guarding	Good condition.			
	Secure.			
Hydraulics	Good condition of hoses (Check for leaks).			
	Good condition of casings (Check for leaks).			
	Good condition of rams (Check for leaks).			
Controls	Correct operation.			
	Responsiveness.			
Structure	Adequate weld condition.			
	Free of cracks/damage.			
Bolts andFasteners	Tight.			
	None Missing.			
	Attachment locking pins in place.			
Decals	Legible.			
	All in place.			
Operating Supplement	Present with machine/attachment .			

LOADER ARM MAINTENANCE

INSPECTION AND CHECKS

Always...

- Secure the Arm when carrying out maintenance activities, particularly when working with the Arm in the raised position. An arm lock is available from parts, **No. 0K11231**



BOOM MAINTENANCE

- Keep a fire extinguisher on hand during maintenance operations.
- Ensure the working area is kept clean and free of oil, grease and debris.
- Designate the effective maintenance work area using witches hats.

Never...

- Rely solely on the machine hydraulics to keep the Arm elevated whilst carrying out maintenance. Arm Locks should always be used to physically hold the boom in the raised position.
- Raise or lower the boom with the Arm Locks in place.



ARM LOCK IN POSITION

SERVICE TASKS - INSTRUMENTS

The following service work should only be carried out by a qualified Service Technician at intervals indicated on the Service Chart.

The operating hours are displayed by the Hour Meter on the Instrument Panel which is found on the right hand side standing on the machine. The display will flash for 2 hours when a service is due. The flashing will cease after a two hour operating period has passed.

INSTRUMENT PANEL



Kid Replacement Key
Kid Replacement Ignition Switch
Hour Clock

Part Number # L115742 Pair
Part Number # L115741
Part Number # L121500

SERVICE TASKS - ENGINE

ENGINE OIL

Change the engine oil after the first 20 hours of operation and thereafter, after every 100 hours. Generally engine oil type SAE 10W-30 is recommended. See Engine Manual for details.

Ambient Temperature	Oil Type
Above 25°C (77°F)	SAE 30 or SAE10W-30/SAE10W-40
0°C to 25°C (32°F to 77°F)	SAE 20 or SAE10W-30/SAE10W-40
Below 0°C (32°F)	SAE 10 or SAE10W-30/SAE10W-40

ENGINE OIL FILTER (PETROL ENGINE) - Part Number # L115905-1

Replace the oil filter after every 100 hours of operation. See Engine Manual for details.

AIR FILTER (PETROL)

HONDA AIR FILTRATION – Part Number # L115905-2 (Element Only Incl Foam)

The pre cleaner foam should be washed out and re oiled when machine is working in dusty conditions every 8 hours of operation. Replace the air filter element after every 100 hours of operation, or sooner if operating in a dusty environment.



HONDA



DONALDSON

DONALDSON AIR FILTRATION -Part Number # L120680 (Outer Element Only)

The pre cleaner bowl should be emptied out and when machine is working in dusty conditions every 8 hours of operation. Replace the air filter element after every 100 hours of operation, or sooner if operating in a dusty environment.

FUEL FILTER – Part Number #L115942

Replace the fuel filter initially after the first 20 hours of operation and thereafter, after every 100 hours of operation. See Engine Manual for details.

IDLE SPEED

Check engine idle speed after every 200 hours of operation, and adjust if out of specification. See Engine Manual for details.

SPARKS PLUGS (PETROL ENGINE) – Part Number # L116023

Replace after every 100 hours. see engine manual for details.

VALVE CLEARANCES (DIESEL ENGINE)

Check and adjust engine valve clearances after every 800 hours of operation. See Engine Manual for details.

SERVICE TASKS - HYDRAULICS

HYDRAULICS

Perform the following checks after every 100 operating hours:

Check hydraulic fluid level, (with arms down, dipstick wound in and oil cold FC-Cold Level Mark) top up with Hydraulic Oil **ISO 68**. The appropriate Full Cold level mark (FC) is indicated on the dip-stick.

NOTE: A significant drop in fluid levels will indicate leakage.



HYDRAULIC OIL
DIP STICK



Inspect all hydraulic hoses, tubes, fittings, valves and rams for leaks and damage. Tighten loose fittings and replace damaged components.

Check all three pressure settings (see procedure on opposite page).
Adjust if necessary.

HYDRAULIC FILTER (RETURN LINE FILTER) - Part Number # L116442

Replace the return line filter cartridge after every 200 operating hours.
(Situated behind the battery compartment.)



HYDRAULIC PRESSURE SETTINGS

The hydraulic system has three pressure settings which have to be set as follows:

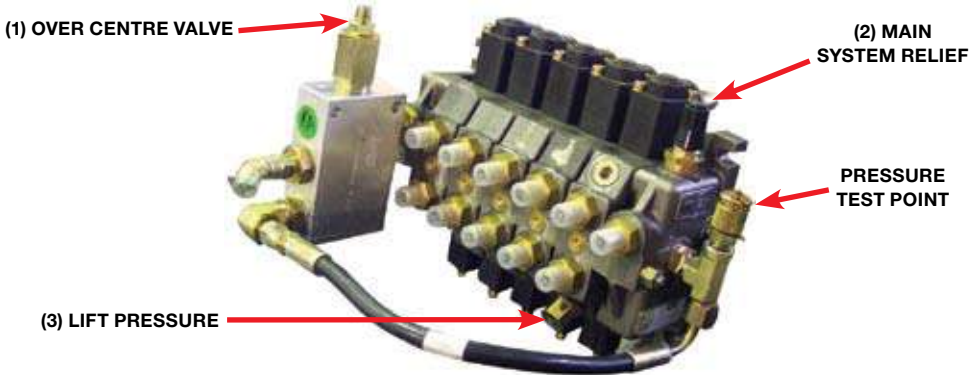

Before any testing is carried out run the engine and hydraulic system to warm the hydraulic oil to **80°C (176°F)**. All pressure setting are performed with the engine running at full speed (**3,600 rpm**).

(1) OVER CENTRE VALVE

Connect an accurate pressure gauge with a range 0-40 bar (0-600 PSI) to the test point.

The pressure should be set at 31.0 bar (450 PSI).

NOTE: If adjustment is required slacken off the lock nut and using a 5mm hex key, wind in the screw to increase the pressure or back off the screw to reduce the pressure. Retighten the lock nut when adjustments are complete.

(2) MAIN SYSTEM RELIEF PRESSURE

Connect an accurate pressure gauge with a range **0-200 bar (0-2,900 PSI)** to the test point.

Check the pressure while pulling the tilt control lever at the end of the ram's stroke.

The pressure should be set at 186 bar (2,700 PSI) for the 16 hp engine.

NOTE: If adjustment is necessary slacken off the lock nut and wind in the screw to increase the pressure or back off the screw to reduce the pressure. Retighten the lock nut when adjustments are complete.

(3) LIFT PRESSURE

Connect an accurate pressure gauge with a range **0-200 bar (0-2,900 PSI)** to the test point.

Check the pressure while pulling the arm control lever at the end of the ram's stroke.

The pressure should be set at 103 bar (1,500 PSI).

NOTE: If adjustment is necessary slacken off the lock nut and wind in the screw to increase the pressure or back off the screw to reduce the pressure. Retighten the lock nut when adjustments are complete.

HYDRAULIC FLUID

Replace the hydraulic oil after every 1,000 operating hours.

(Hydraulic Oil **ISO 68**).

Oil Drain Plug

(Situated beneath front axle).



SERVICE TASKS - VISUAL

VISUAL CHECK

Check all over machine for loose bolts, cracks and dents after every 100 operating hours. Tighten loose bolts, and replace if worn or damaged.

SERVICE TASKS - BATTERY

BATTERY- Part Number # L114382

The battery provided with the Loader is maintenance free. An indicator at the top of the battery displays its condition according to a displayed colour. Ensure that the terminals are tight and that covers and battery leads are not damaged.

SERVICE TASKS - GREASE NIPPLE

GREASE

Grease* all linkage pins after every 8 operating hours and inspect for wear all linkage pins every 100 operating hours. (Grease type Castrol APX T or equivalent)

* The frequency for regreasing depends on the workload and the severity of the working conditions. Regreasing during the day of operation may be necessary (see Daily Checks Page).

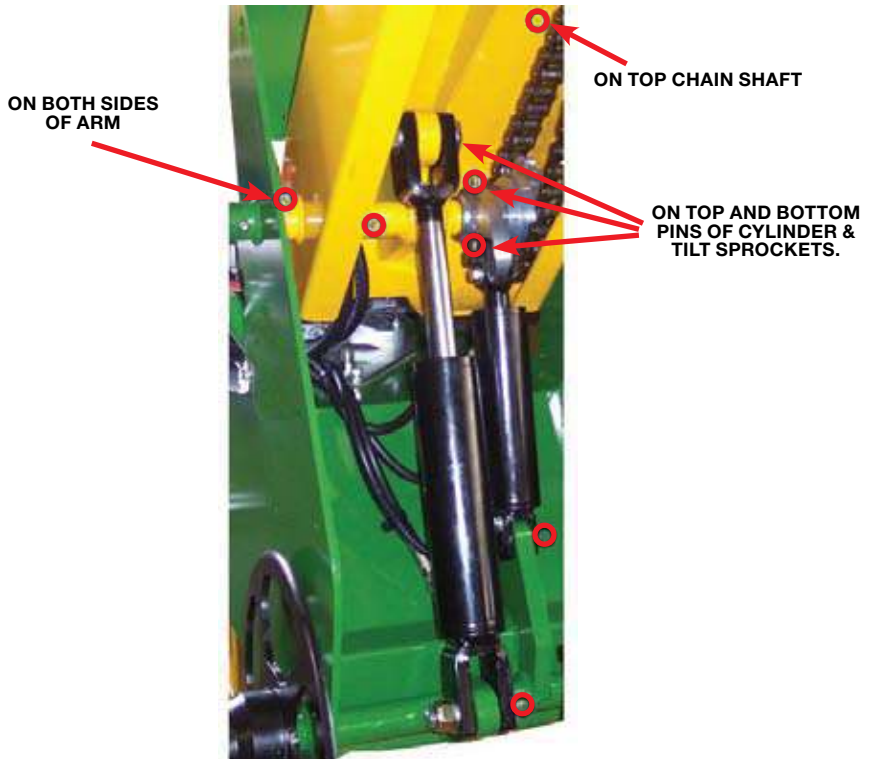

○ Grease Nipples Regreasing during the day of operation may be necessary (See Daily Checks).

SERVICE TASKS - PIVOT PINS

BOTTOM PIVOT PINS

Before every use, visually inspect all pivot pins for any signs of wear and damage or possible failure. Thoroughly inspect all pivot pins and bushes for wear and damage at an interval of 200 operating hours.



**Pivot Pin Part
No. L110620**

**Attachment Plate Part
No. 0K11511**

SERVICE TASKS - TILT CHAIN

TILT CHAIN

Check the tension of the tilt chain after every 200 operating hours. If the slack exceeds **10mm (3/8")** adjustment becomes necessary.

ADJUSTMENT PROCEDURE

1. Slacken adjustment screw lock nut **(1)**
2. Slacken adjuster block Clamp Nut **(3)**
3. Turn Adjuster Screw **(2)** clockwise to increase chain tension counter clockwise to decrease chain tension. Chain tension is correct when the middle of the non adjustment loop of the chain can be moved 10mm (3/8").
4. When adjustment is correct, tighten lock nut **(1)** and adjuster block Clamp Nut **(3)**. Check to confirm chain adjustment is still correct, readjust if required.

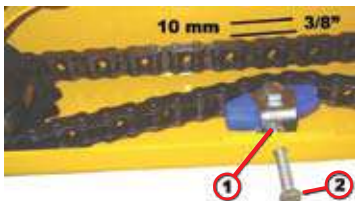

**TILT SPROCKET
TILT CHAIN
TILT CHAIN LINK
TENSIONER BLOCK**



**Part Number #0K11261
Part Number #L111250
Part Number #L111250-1
Part Number #L112620**

SERVICE TASKS - TYRES & PRESSURE

TYRES

Visually check tyres on a daily basis and check tyre pressure every 50 operating hours, and check for wear and damage to tyres and tracks.

MODEL	TYRE	RECOMMENDED PRESSURE	
		KPA	PSI
TK216	400 X 8 - 8 PLY	483	70
KK216	570 X 8 COMBO	345	50

Tyre pressures:

Note: The tyre pressures in track models are to be kept at a minimum of 62psi to prevent slipping with a maximum pressure not to exceed 90psi. Adjust as required to accommodate for wear.

Rim suit Kid Track and Wheel

Tube suit Track Drive

Tube Suit Combo

Tyre Track Drive

Tyre Lug/Turf Combo

Wheel Studs

Wheel Nuts

Part Number # L114020

Part Number # L114075

Part Number # L114048

Part Number # L114071-1

Part Number # L114045

Part Number # L112730

Part Number # L114300

SERVICE TASKS - DRIVE CHAIN

CHAIN TENSIONERS - PART NUMBER # 0K12601

Check the tension of the drive chains every 200 hours. The slack can be adjusted by turning one or both chain tensioning blocks (1) by 180°. If no adjustment is possible anymore, replace the chain tensioning blocks.

NOTE: Secure bolts (2) with Loctite. Lubricate chain with grease.

To access the drive chain, power to the loader has to be isolated, wheels chocked, jacked up on one side and supported. Remove two wheels and the chain guard to access the Chain Tensioner. Ensure guards and wheels are correctly refitted after maintenance works are completed.

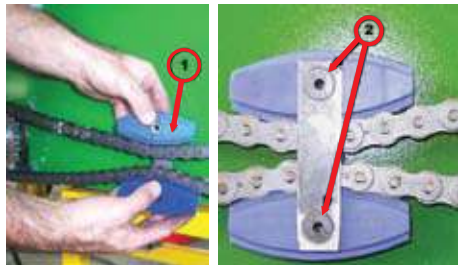

CHAIN TENSIONERS - PART NUMBER #0K12601

DRIVE CHAIN LINK - PART NUMBER # L117700

TRACK - TK216

CONVERSION KIT KK216 TO TK216 Part Number (0K10113-46)

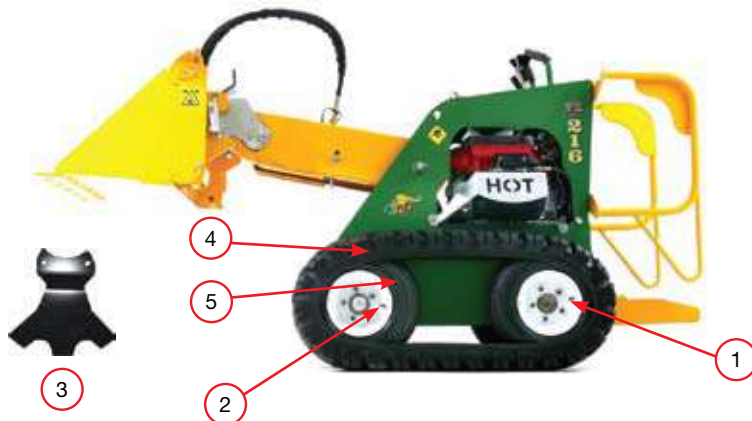

No	STOCK CODE	DESCRIPTION	QTY
1	0K12692	HUB DRIVE TRACK KID	2
2	0K12792	HUD IDLER TRACK KID	2
3	0K14062	KID TRACK TOOL	1
4	0K14063	KID TRACK TYRE 16 PLY	2
5	0K14074	WHEEL TRACK DRIVE KID	4
	PI-100001	SPLIT PIN ZINC 3.2X50 MM	4
	L118644	DECAL TYRE PRESSURE 70 PSI TO 90 PSI	1

HUB CONVERSION

1. With the Loader elevated and secured; remove the wheels. For safety, support the loader from above by means of a hoist or block and tackle. **(Fig.1.)**
2. Remove the mud guards.
3. Remove the drive chain and tensioner.
4. Remove the split pins and loosen the hub nuts.
5. Using a hub-puller, remove the drive and idler hubs; ensure the main nut remains on the shaft to prevent the hub from suddenly falling off.
6. Ensure the Idler hubs are packed with bearing grease and fit the Track Drive and Idler hubs accordingly. Make sure the keys are correctly positioned on the drive shafts when repositioning the drive hubs.
7. Tighten the hub nuts sufficiently to ensure the hub butts up against the base of the shaft and line up the split pin holes with the castle nut. Do not over-tighten the nut.
8. Fit the split pins and idler hub dust covers.
9. Fit wheels to one side leaving 2 nuts opposite the valve off the (rear) Drive Wheel for the Track Drive Installation Tool.

TRACK INSTALLATION

TRACK INSTALLATION

1. Raise the loader and place on a secure stand. A height of about 18 inches/46cm is convenient for this procedure.
2. For safety, support the loader from above by means of a hoist or block and tackle. **(Fig.1)**
3. On the rear wheel, remove two wheel nuts across from one another, opposite to the valve and attach the track tool facing away from the valve. **(Fig. 2)**
4. Start the engine and using low engine speed and gentle movement, slowly rotate the track tool to the 9 O'clock position. **(Fig. 2)**



CAUTION: Ensure there are no loose objects or parts of your body or clothing in proximity to rotating parts.

5. Raise the arm sufficiently to provide clearance between the attachment plate and track. Deflate both tyres completely. **(Fig. 3)**
6. Position the track over the front wheel and over the track tool which is fitted on the rear wheel. **(Fig. 4)**
7. Using low engine revs and gentle action on the lever related to the side you are fitting, rotate the wheel in reverse about a ¼ turn. (90°). Ensure the track tool has positioned inside the track, and the track is aligned at the bottom of the front wheel. **(Fig. 5)**
8. Use the bottom of your boot to kick the track back into alignment with the wheel. Apply the same adjustment to the top of the rear wheel if necessary. **(Fig. 6)**



CAUTION: Do not attempt to kick the track into alignment whilst the track or wheel is rotating. Keep clear of all moving parts.

9. Use small movements in reverse ensuring you stop to guide the track back into alignment on both wheels; continue until the track is completely fitted and correctly aligned on the wheels.
10. Return the track tool to 9 O'clock and remove. Replace wheel nuts and tighten securely. **(Fig. 7)**
11. Inflate the tyres to 30 PSI and ensure the track runs true over the wheels. **(Fig. 8)**
12. Inflate the tyres to 70 PSI and test. **(Fig. 8)**

FIT TRACK AS SHOWN BELOW



FIG. 1



FIG. 5



FIG. 2



FIG. 6



FIG. 3



FIG. 6



FIG. 4



FIG. 6

DECALS

STOCK CODE	DESCRIPTION	QUANTITY
L118420	NAME PLATE KANGA KID VHB TAPE	1
L118480	NAME PLATE HYDRAULIC OIL VHB TAPE	1
L118500	NAME PLATE UNLEADED FUEL ONLY VHB TAPE	1
L118511	KEY RING KANGA	1
L118541	DECAL KANGA LOADERS AUST	1
L118544	DECAL KANGAROO AUST RH/LH 4 PER SHEET	0.5
L118546	DECAL KANGA POWER LH & RH	1
L118550	DECAL OPERATOR SAFETY 5-6-7-8 SERIES	1
L118551	DECAL KID CONTROL PANEL	1
L118553	DECAL KANGA KID AUST RH	1
L118558	DECAL HIDDEN BEARING	1
L118560	DECAL MAX LEVEL	1
L118561	DECAL CRUSH TRIANGLE	2
L118562	DECAL LIFT HOOK	1
L118563	DECAL TIE DOWN	2
L118565	DECAL AUST MADE TRIANGLE	1
L118568	DECAL IGNITION SWITCH	1
L118578	DECAL SWL 100-220LBS	1
L118580	SAFETY INSTRUCTIONS DVD	1
L118591	DECAL KK216	2
L118593	DECAL TK216	2
L118594	DECAL DIAL 1100 BEFORE YOU DIG	1
L118596	DECAL NO SMOKING 50 MM DIA	1
L118597	DECAL EAR & EYE PROTECTION 50 MM DIA	1
L118644	DECAL TYRE PRESSURE 70 PSI TO 90 PSI	1
L118668	DECAL TRACK INSTALLATION INSTRUCTIONS	1
L118671	DECAL 1300 SERVICE NUMBER	1

SERVICE CHART

MAINTENANCE INTERVAL		NUMBER OF HOURS															
		TYPE	MIN	INT	MIN	INT	MAJ	MIN	INT	MIN	INT	MAJ	MIN	INT	MIN	INT	MAJ
HOURS		100	200	300	400	500	600	700	800	900	1000	1100	1200	1300	1400	1500	
ENGINE OIL (PETROL)		R	R	R	R	R	R	R	R	R	R	R	R	R	R	R	
ENGINE OIL FILTER (PETROL)		R	R	R	R	R	R	R	R	R	R	R	R	R	R	R	
AIR FILTER ELEMENT *		R	R	R	R	R	R	R	R	R	R	R	R	R	R	R	
FUEL FILTER *		R	R	R	R	R	R	R	R	R	R	R	R	R	R	R	
SPARK PLUG (PETROL)		R	R	R	R	R	R	R	R	R	R	R	R	R	R	R	
IDLE SPEED (PETROL)		A	A	A	A	A	A	A	A	A	A	A	A	A	A	A	
VALVE CLEARANCE (PETROL)		A	A	A	A	A	A	A	A	A	A	A	A	A	A	A	
HYDRAULIC HOSE/ TUBE		I	I	I	I	I	I	I	I	I	I	I	I	I	I	I	
HYDRAULIC FLUID (ISO68)		I	I	I	I	I	I	I	I	I	R	I	I	I	I	I	
HYDRAULIC RETURN FILTER		R	R	R	R	R	R	R	R	R	R	R	R	R	R	R	
TYRE PRESSURES		I	I	I	I	I	I	I	I	I	I	I	I	I	I	I	
ITEMS TO BE CHECKED ON A DAILY BASIS																	
DAILY																	
	HOURS	8	8	8	8	8	8	8	8	8	8	8	8	8	8	8	8
PRE-CLEANER FOAM *		C	C	C	C	C	C	C	C	C	C	C	C	C	C	C	C
VISUAL CHECK (CRACKS, WEAR)		I	I	I	I	I	I	I	I	I	I	I	I	I	I	I	I
GREASE NIPPLES/ PINS		L	L	L	L	L	L	L	L	L	L	L	L	L	L	L	L

* Denotes - May need Serviced at more regular intervals if working in dusty conditions.

R	Replace
C	Clean as required
L	Lubricate as Necessary

A	Adjust as Necessary
I	Inspect, Fill Up, Tighten or Replace as Necessary

Note.
The warranty on the equipment is subject to the periodic maintenance being carried out at the intervals specified. If a service provider other than Kanga Loaders is used, maintenance records from the trade qualified provider may be required to support any claim. Only Genuine Kanga spare parts should be used during servicing

MAINTENANCE SCHEDULE 2 SERIES

	MINOR SERVICE 100Hr	INTERMEDIATE SERVICE 200Hr	MINOR SERVICE 300Hr	INTERMEDIATE SERVICE 400Hr	MAJOR SERVICE 500Hr
MODEL	DATE _____	DATE _____	DATE _____	DATE _____	DATE _____
TK/KK Series	SERVICE STAMP	SERVICE STAMP	SERVICE STAMP	SERVICE STAMP	SERVICE STAMP
	INTERMEDIATE SERVICE 600Hr	MINOR SERVICE 700Hr	INTERMEDIATE SERVICE 800Hr	MINOR SERVICE 900Hr	MAJOR SERVICE ** 1000Hr
MODEL	DATE _____	DATE _____	DATE _____	DATE _____	DATE _____
TK/KK Series	SERVICE STAMP	SERVICE STAMP	SERVICE STAMP	SERVICE STAMP	SERVICE STAMP

MAINTENANCE SCHEDULE 2 SERIES - Continued

	MINOR SERVICE 1100Hr	INTERMEDIATE SERVICE 1200Hr	MINOR SERVICE 1300Hr	INTERMEDIATE SERVICE 1400Hr	MAJOR SERVICE 1500Hr
MODEL	DATE _____	DATE _____	DATE _____	DATE _____	DATE _____
TK/KK Series	SERVICE STAMP	SERVICE STAMP	SERVICE STAMP	SERVICE STAMP	SERVICE STAMP
	INTERMEDIATE SERVICE 1600Hr	MINOR SERVICE 1700Hr	INTERMEDIATE SERVICE 1800Hr	MINOR SERVICE 1900Hr	MAJOR SERVICE ** 2000Hr
MODEL	DATE _____	DATE _____	DATE _____	DATE _____	DATE _____
TK/KK Series	SERVICE STAMP	SERVICE STAMP	SERVICE STAMP	SERVICE STAMP	SERVICE STAMP

NOTE:

The warranty on the equipment is subject to the periodic maintenance being carried out at the intervals specified. If a service provider other than Kanga Loaders is used, maintenance records from the trade qualified provider may be required to support any claim.

Only genuine Kanga spare parts should be used during servicing.

** Denotes Hydraulic oil and Pressure filter require Changing for 1000Hr Services

SPECIFICATIONS - 2 SERIES

PERFORMANCE	KK216		TK216	
Max. lift capacity	100kg	220 lbs	100kg	220 lbs
Travel speed	5.4km	3.4 mph	5.4km	3.4 mph
Operating weight (incl. bucket)	470 kg	1,034 lbs	500 kg	1,100 lbs
ENGINES				
Make	Honda GXV530		Honda GXV530	
Power	11.8kw	16hp	11.8kw	16hp
DRIVE SYSTEM				
Drive Control Soft Touch	Hand levers		Hand levers	
Throttle Control	Hand lever		Hand lever	
Wheels / Tracks	Wheels		Tracks	
HYDRAULICS				
Gear pump displacement	6.2cc/rev	0.378 cu.in/rev	6.2cc/rev	0.378 cu.in/rev
Pump output	22l/min	5.8 gUS/min	22l/min	5.8 gUS/min
System pressure	186bar	2700psi	186bar	2700psi
Hyd. reservoir capacity	51.5L	13.6g US/min	51.5L	13.6g US/min
BUCKETS				
Standard bucket capacity	0.075m ³	2.6 cu.ft	0.075 m ³	2.6 cu.ft
4 in 1 bucket capacity	0.075 m ³	2.6 cu.ft	0.075 m ³	2.6 cu.ft
DIMENSIONS				
	mm	inch	mm	inch
A. Max. operating height	1570	61.8	1580	62.2
B. Height to hinge pin	1175	46	1185	47
C. Overall height	1200	47	1210	48
D. Overall length	2070	81.5	2070	81.5
E. Overall wheel width	770	30.3	800	31.5
F. Bucket max. reach at 40°	350	14	340	13.4
H. Angle of departure	35°		36°	
I. Max. roll back	36°		36°	
J. Bucket width	800	31.5	800	31.5
K. Overall length less bucket	1560	61.4	1560	61.4
L. Ground clearance	150	6	160	6.3

* Net power the Power rating of the engine indicated in this document is the net power of the production engine only and is measured in accordance with SAE J 1349 at 3600 Rpm, Mass production engines may vary from this value, Actual power output for the engine installed in the final machine May vary depending on numerous factors, including operation speed of the engine in application, environmental conditions and other variables.

DIMENSIONS - 2 SERIES

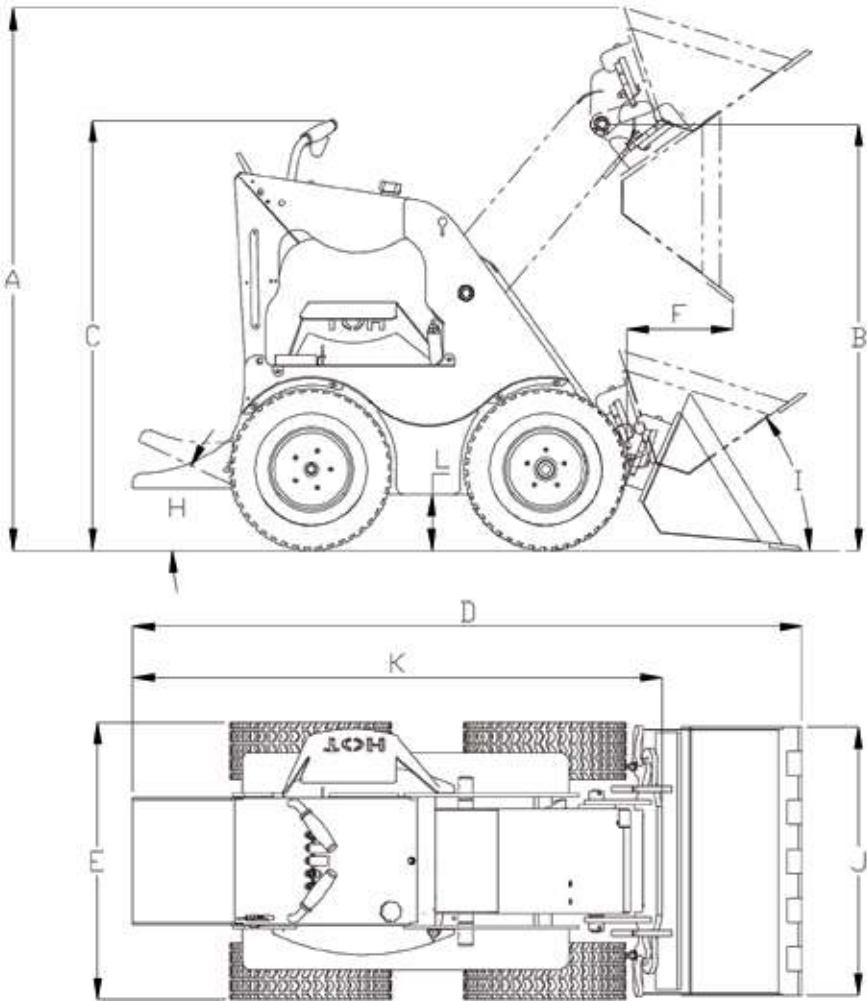

TROUBLE SHOOTING

This section contains trouble-shooting information to be used for locating and correcting problems which may develop with your KANGA Loader. Troubleshooting and maintenance information relating to the engine are contained in the Engine Manual.

ARMS

TROUBLE	PROBABLE CAUSE	REMEDY
Arm will not rise.	Load capacity exceeded.	Reduce load. Load should not exceed the specified SWL displayed on the machine.
	Hydraulic system oil level low.	Check oil and replenish as necessary. Oil level should not change. Leaks may be present.
	Damaged or blocked hydraulic line.	Remove line and remove any obstructions or replace line as necessary.
	Malfunctioning hydraulic pump.	Replace Hydraulic Pump as necessary.
	Worn Control Valve spool.	Check pressure delivery from Control Valve. Contact Service Agent.
	Lift Control Valve relief set too low, allowing oil to return to reservoir.	Adjust relief valve to proper setting. Contact service Agent.
	Excessive oil leak past lift cylinder piston seal.	Repair or replace cylinder as necessary.
Arm will not lower.	Hydraulic oil system low.	Check oil and replenish as necessary. Oil level should not change. Leaks may be present.
	Damaged or blocked hydraulic line.	Remove line and remove any obstructions or replace line as necessary.
	Malfunctioning pump	Replace Hydraulic Pump as necessary.
	Worn Control Valve spool.	Check pressure delivery from Control Valve. Contact Service Agent.
	Control rod or lever broken or disconnected.	Repair or replace control rod or lever.
Arm Lowers with control lever in neutral.	Worn Control Valve spool.	Repair or replace valve as required.
	Lift ram piston seal leaking.	Replace seals.
Arm will not rise, or rises slowly.	Lift Control Valve relief set too low allowing oil to return to reservoir.	Adjust relief valve to proper setting. Contact Service Agent.
	Worn Control Valve spool.	Check pressure delivery from Control Valve. Contact Service Agent.
	Excessive oil leak past lift cylinder piston seal.	Repair or replace cylinder as necessary.

	Control rod or lever broken or disconnected.	Repair or replace control rod or lever.
	Hydraulic lines incorrectly connected at Control Valve.	Correctly connect line at Control Valve.
Arm rises and lowers erratically.	Lift Control Valve relief set too low, allowing oil to return to reservoir.	Adjust relief valve to proper setting.
	Hydraulic system oil low.	Check oil and replenish as necessary. Oil level should not change. Leaks may be present.
	Damaged or blocked line.	Remove line and remove any obstructions or replace line as necessary.
	Malfunctioning pump.	Repair or replace hydraulic pump as necessary.
	Worn Control Valve spool.	Check pressure delivery from Control Valve. Repair or replace valve as required.
	Excessive oil leak past lift cylinder piston seal.	Repair or replace cylinder as necessary.
	Arm pivot pin seized or otherwise damaged.	Replace pivot pin and bushing as necessary. Grease thoroughly.

HYDRAULIC PUMP

TROUBLE	PROBABLE CAUSE	REMEDY
Flow from hydraulic pump erratic or non existent.	Hydraulic system oil low.	Check oil and replenish as necessary. Oil level should not change. Leaks may be present.
	Damaged or blocked line.	Remove line and remove any obstructions or replace line as necessary.
	Worn or chipped pump gears.	Replace pump gears as necessary.
	Worn or broken drive shaft or coupling.	Inspect drive shaft or coupling. Repair or replace as necessary.
Hydraulic pump noisy.	Air in hydraulic system.	Check suction side or hydraulic system for defects and repair as necessary. Ensure no leaks exist in the suction line.
	Hydraulic system oil low.	Check oil and replenish as necessary. Oil level should not change. Leaks may be present.
	Worn or broken drive shaft or coupling.	Inspect drive shaft or coupling. Repair or replace as necessary.
	Worn or chipped pump gears.	Replace pump gears as necessary.

DRIVE SYSTEM

TROUBLE	PROBABLE CAUSE	REMEDY
Machine will not drive forwards or backwards.	Hydraulic system oil low.	Check oil and replenish as necessary. Oil level should not change. Leaks may be present.
	Worn Control Valve spool.	Check pressure delivery from Control Valve. Repair or replace valve as required.
	Damaged or blocked line.	Remove line and remove any obstructions or replace line as necessary.
	Control rod or lever broken or disconnected.	Repair or replace control rod or lever.
	Hydraulic lines incorrectly connected at Control Valve.	Correctly connect line at Control Valve.
	Malfunctioning pump.	Repair or replace pump.
Machine drive speed is erratic.	Hydraulic system oil low.	Check oil and replenish as necessary. Oil level should not change. Leaks may be present.
	Damaged or blocked line.	Remove line and remove any obstructions or replace line as necessary.
	Binding drive motor(s).	Repair or replace motor(s) as necessary.
	Relief valve setting.	Adjust relief valve.

ENGINE

TROUBLE	PROBABLE CAUSE	REMEDY
Engine will not crank over.	Low battery output.	Recharge or replace battery.
	Loose, disconnected or broken battery cables.	Inspect cable(s) and tighten all connections. Repair or replace cables as necessary.
	Faulty Starter.	Repair or replace starter.
	Faulty circuit wiring.	Check wiring continuity.
Engine cranks but not fires.	No fuel in tank.	Refill fuel tank.
	Dirty fuel filter.	Clean filter.
Engine runs but stalls.	Fuel valve closed.	Open valve.
	Low battery output.	Recharge or replace battery.
	Power take-off engaged.	Shift power take-off lever into neutral.

AUXILIARY HYDRAULIC

TROUBLE	PROBABLE CAUSE	REMEDY
Attachment is slow or will not function.	Hydraulic system oil low.	Check oil and replenish as necessary. Oil level should not change. Leaks may be present.
	Damaged or blocked line.	Remove line and remove any obstructions or replace line as necessary.
	Malfunctioning pump.	Replace Hydraulic Pump as necessary.
	Worn Control Valve spool.	Check pressure delivery from Control Valve. Repair or replace valve as required.
	Attachment plate pivot pin seized or otherwise damaged.	Replace pivot pin and bushing as necessary. Grease thoroughly.
	Excessive oil leak past cylinder piston seal or motor rotating group.	Repair or replace cylinder motor as necessary.
	Control rod or lever broken or disconnected.	Repair or replace control rod or lever.