

Operation Manual

XN12-9

Applicable model number

XN12-9



Please read this manual and fully understand its content before proceeding with the operation, inspection and maintenance of this machine

<https://tractormanualz.com/>

Safety Warning Signs



This sign denotes a safety warning. The information behind the sign includes important safety information. Please read and understand this information to prevent personal injuries or deaths.

The machine owner or employer is responsible for instructing every operator to operate all equipment correctly and safely in detailed manner. All personnel operating this machine shall sufficiently understand the contents of this manual.

Before operating the machine, all operation personnel must receive the guidance on related functions of excavator.

Before operating this machine in a working site, learn and practice how to use the machine controls correctly in a safe and spacious place.

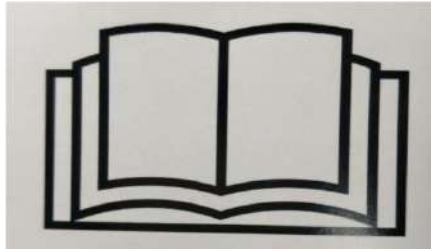

The improper methods during operations, checking, and maintenance of machine will result in injuries or deaths.

Before any operation, checking, or maintenance of machine, please read and understand this manual.

Please always carry this manual with you. It's preferable to preserve this manual on the machine. If this manual is lost or damaged, please immediately order a new manual from a dealer. At the transfer of this machine, please ensure to hand this manual over to the new owner.

The machine supplied by Ken stone Heavy Machinery conforms to the local standards and specifications of the country exported. If your machine is purchased from other country or from an individual or company of other country, this machine is probably not installed with the safety devices or safety standards required for the operations of this machine in your country. If you have any doubt on the compliance of your machine with the relevant standards and regulations in your country, please contact a Ken stone dealer.

Signal Words

The safety information on this manual and machine identifications is indicated by words “Danger”, “Warning”, and “Notice”. The meanings of these signal words are as below:

Danger

“Danger” denotes high dangerous level, for which the negligence will result in death or serious injury.

Warning

“Warning” denotes medium danger level, for which the negligence will probably result in death or serious injury.

Notice

“Notice” denotes low danger level, for which the negligence will result in minor or medium injuries.

Important: The word “Importance” is intended to alert the operation and maintenance personnel of the possible damages of machine and its components.

It’s impossible for us to predict all possibly existed dangers. Therefore, the warnings in this manual or on this machine can’t cover all possible accidents. Therefore, during the operations of machine, ensure to take cautions and abide by all conventional safety measures to prevent harms to machine, operation personnel, or other personnel.

Introduction

Foreword

This manual describes the operations, checking, and maintenance of this machine and the safety descriptions to be observed during operations. Should you have any doubt, please contact a dealer or service provider of Ken stone Heavy Machinery.

- In some details, this manual probably differs from the manual attached on the machine in use.
- Please be noted that the information contained in this manual and the parameters of machine are subject to changes without further notice.

The manual is in the circular manual box behind the seat

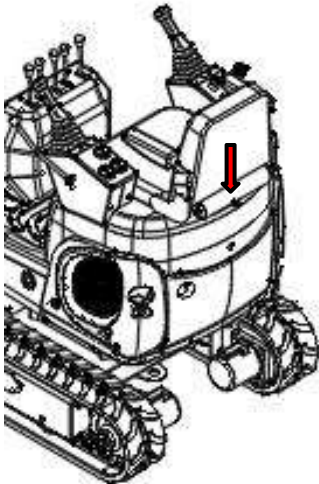

Serial number

Important: Do not disassemble the machine nameplate with serial number. Observe the serial numbers of machine and engine and record them in the blank area below.

Machine No.:

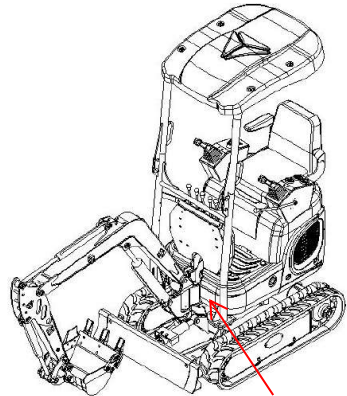

Engine No.:

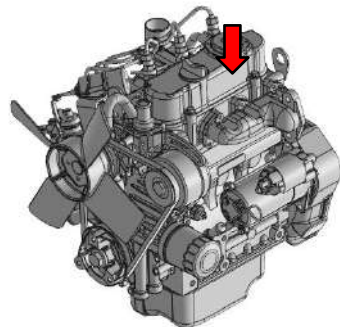

Introduction

Front, Rear, Left, and Right

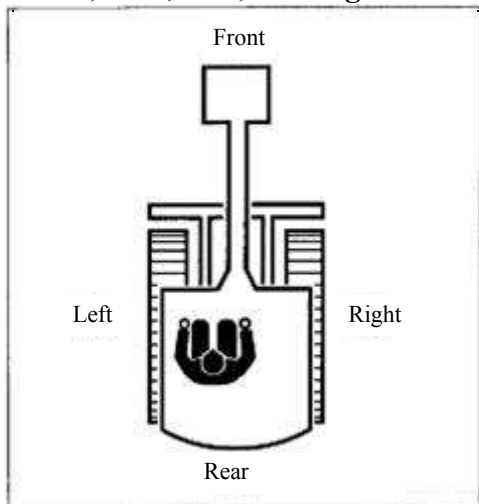

The front, rear, left, and right of the machine indicated in this manual are based on the status sitting in the driver seat, with the bulldozing blade visible in the front.

Designated Operations

This machine is mainly applied for following operations:

- Digging
- Ditching
- Side ditching
- Leveling
- Loading

Product Features

- Small size, flexible operation
- Can be equipped with a variety of attachments
- Track width "flexible machine width structure"

Run-in period

For the first 100 hours of the new machine (as indicated by the timer), please follow the instructions below:

Using the new machine without run-in will deteriorate acceleration performance and probably shorten the life of machine.

- Sufficiently warm up the engine and hydraulic oil.
- Avoid heavy-load and rapid operations. Maintain the load at approximately 80% of maximum load capacity during operations.
- Do not start, accelerate, steer, or stop suddenly, unless it's really necessary.



Introduction

Notes about Reading of This Manual

Please be noted that the descriptions and graphics contained in this manual probably are not applicable for your machine in use. The numbers in graphics are marked by circles. The same numbers in the descriptions are marked in parentheses. (For instance: ①→(1))

Signs used in this manual

The meanings of the signs used in this manual are as below.

 ,  Prohibition

 Lock

 Unlock

Noise and vibration

A-Weighted emission sound pressure level at the operator's position measured according to work cycle procedures specified in "ISO 6396 " is 78dB(A), The hands and arms are exposed to a weighted root mean square acceleration that is less than 2.5 m/s².

The body is exposed to a weighted root mean square acceleration that is less than 0.5 m/s².

Measurements are obtained on a representative machine using the procedures in the following standards: "ISO 2631-1" "ISO 5349-1" "ISO 5349-2"

Contents

Signal words.....	0-1	Transportation.....	4-1
Introduction.....	0-2	Loading and Unloading.....	4-2
Safety.....	1-1	Lifting of Machine.....	4-4
General Precautions.....	1-2	Fixing of Machine.....	4-6
Precautions during Preparations.....	1-8	Maintenance.....	5-1
Safety Measures at Start.....	1-10	Overview.....	5-2
Operation Precautions.....	1-12	Service Data.....	5-4
Precautions for Parking.....	1-22	Critical Safety Parts.....	5-11
Precautions during Transport.....	1-23	Maintenance List.....	5-13
Precautions for Maintenance.....	1-25	Walk-Around Checking.....	5-15
Safety Signs.....	1-35	Daily routine checking (Every 10h).....	5-17
Controls.....	2-1	After first 50h (For new machine only).....	5-23
Component Name.....	2-2	Every 50h.....	5-25
Cover(Start Key / engine cover / fuse case / fuel filler port).....	2-4	Every 250h.....	5-30
Seat.....	2-6	Every 1000h.....	5-35
Electrical control panel.....	2-8	Every 1500h.....	5-39
Switches (start switch / horn button).....	2-10	Every 2000h.....	5-40
Joysticks.....	2-11	As necessary.....	5-42
Accessory.....	2-14	Maintenance during Long-Time Parking.....	5-49
Operations.....	3-1	Troubleshooting.....	6-1
Before Operations.....	3-2	Symptoms that are not malfunctions.....	6-2
Start and Stop of Engine.....	3-3	Engine Overheating.....	6-3
Operate Machine.....	3-7	No Battery Power.....	6-4
Operations Procedures.....	3-17	Burnout of Fuse.....	6-6
Parking of This Machine.....	3-26	Restart after Refueling.....	6-8
Treatment in Cold Weather.....	3-28	Flashing of Warning Lamps.....	6-9
Handling of Rubber Tracks.....	3-29	Other Symptoms.....	6-10
		Towing.....	6-12

Parameters.....	7-1
Basic Parameters.....	7-2
Overall Dimensions of Machine.....	7-3
Operating Range.....	7-4
Machine lifting power.....	7-5
Accessories.....	8-1
General Safety Measures	8-2
Precautions.....	8-5
Hydraulic Hammer	8-6
Optional accessories.....	8.11
Parts number position.....	8-13

Safety



General Precautions

You are liable to abiding by the safety laws and regulations of relevant departments and fulfilling the operations, checking, and maintenance of machine.

As a matter of fact, all accidents are caused by the non-compliance with basic safety rules and precautions.

Most accidents can be avoided by authenticating the potential dangers in advance.

Please read and understand all safety

information related to the prevention of accidents. Please ensure to operate the machine only after you have understood how to operate, check, and maintain the machine correctly.

Abiding by All Safety Regulations

- The machine must be operated, checked, and maintained by trained and qualified personnel.
- During the operations, checking, and maintenance of machine, ensure to understand and abide by all rules, regulations, precautions, and safety measures.
- Do not operate, check, or maintain the machine under the adverse influence of alcohol, drug, medicine, or fatigue or

under sleepy status.

Upon detection of machine abnormality

During the operations, checking, or maintenance of machine, upon detection of any machine abnormality (Such as noise, vibration, smell, abnormal instrument, smoking or oil leakage, error warning indication, and abnormal display of electric control panel), immediately notify a sales or service dealer and take appropriate measure. Do not operate the machine before the abnormality is solved.

Operating Temperature Range

To maintain the performances and prevent the earlier wear of machine, please abide by the following operating conditions.

- Do not operate the machine when the outside temperature is more than +45°C or less than -15°C
- The operations under +45°C outside temperature will probably result in engine overheating and deteriorated engine performance. In addition, the hydraulic oil will probably become really hot to harm the hydraulic devices.
- The operations under 15°C outside temperature will probably harden the rubber parts (Such as gaskets) and cause earlier wear or damage of machine.
- To operate the machine under the



condition beyond above-mentioned outside temperature range, please consult with your sales or service dealer.

Wearing Appropriate Clothing and Protective Appliances



- Do not wear loose clothing or wear decorative articles that will probably hitch to any joystick or motion part.
- Do not wear oil or fuel contaminated clothing that is easily vulnerable to fire.
- As per the requirements of working environment, wear safety shoes, safety helmet, safety goggles, filtration mask, thick gloves, ear flaps, and other protective appliances. During the use of grinding miller, breaking hammer, or compressed air, please wear appropriate protective appliances, such as safety goggles and filtration mask, as the splashing of metal chippings or other objects will probably

cause serious harms.

- Please use the hearing protection devices during the operations of machine. Exposure to a high noise environment for a long time will result in harm or even complete loss of hearing.

Installation of Fire Extinguisher and First-Aid Kit

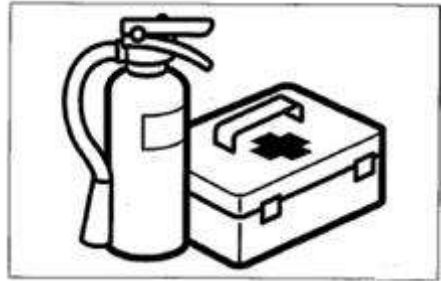

Fulfill the preparations for fire and accident.

- Install the fire extinguisher and first-aid kit and learn how to use them.
- Learn how to extinguish fire and handle accident.
- Know how to contact emergency aid and fabricate the emergency contact list.

Safety

General Precautions

No Disassembling of Safety Devices

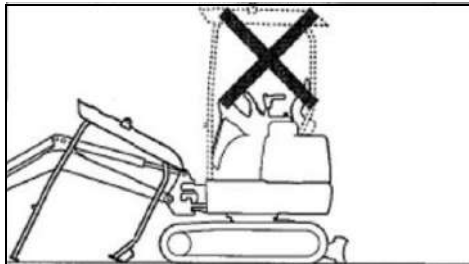

- Please ensure that all guardrails, shelters, and doors are installed properly and securely. Before operating the machine, please repair or replace damaged parts.
- Know how to use safety lock handle, seat belt, and other safety devices and understand the correct operation methods.
- Do not disassemble any safety device, unless for the purpose of checking and repair. Always keep all safety devices under good working condition.

Setup of Signaler and Flagman

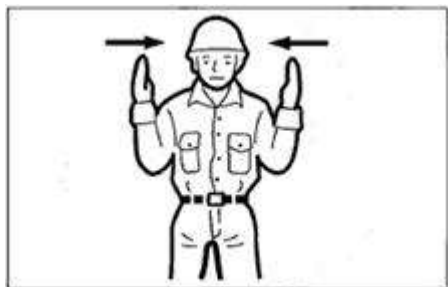

Learn how to use the gestures of specific operation needs and designate the person

responsible for making gestures.

- All personnel must completely understand all gestures.
- The operator must respond to the gestures of designated person only. However, the operator must abide by the stop gesture made by anyone in all cases.
- The signaler must stand in a clearly visible place while making the gestures.

Precautions for Standing up from or Leaving Driver Seat

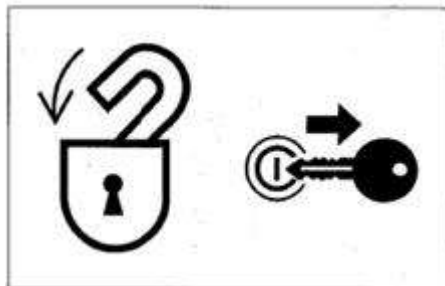

- Before standing up from the driver seat to open/close windows or disassemble/install the lower window, lower the working device onto the ground, lift up and lock the safety lock handle, and stop the engine. When the safety lock handle is lowered down (Unlocked), the accidental touch of any joystick will result in sudden movement of machine and cause serious injuries or deaths.



Safety

General Precautions

- Please be noted that, even if the safety lock handle is placed at locking position, the bulldozing blade, boom, and auxiliary hydraulic controls can't be locked.

Do not touch such controls accidentally.

- While lifting up or lowering down the safety lock handle, take cautions not to touch any joystick.

Before leaving the driver seat, lower the working device onto the ground, lift up the safety lock handle to locking position, and stop the engine. Meanwhile, ensure to withdraw the key, close the doors and hoods, and carry the key with you and then preserve it in a designated place.

Guard against Fire and Explosion Dangers



Keep fuel, lubricating oil, grease, and antifreeze away from flame. The fuel is especially inflammable and really dangerous.

- Handle these inflammable away from ignited cigarette, match, lighter, and other flame or fire source.
- Do not smoke or use open fire while handling fuel or performing the operations of fuel system.
- Do not leave the operation site while filling fuel or lubricating oil.
- Do not disassemble the fuel tank cap or refuel while the engine is running or is not cooled down. In addition, do not splash fuel to any machine hot surface or electronic system part.
- Immediately clean the overflow fuel or lubricating oil thoroughly.
- Check for leakage of fuel and lubricating oil. Please eliminate the leaks and clean the machine before operations.
- Please move the inflammable to a safe place before polishing or welding operations.
- Do not cut or weld any pipeline or pipe that probably contains inflammable liquid. Please clean thoroughly by non-inflammable solvent before cutting or welding.
- Remove all wastes and impurities from machine. Ensure that there is no oil contaminated rag or other inflammable on the machine.
- Handle all solvents and dry chemicals



(Foam fire extinguisher) as per the manufacturer's procedures indicated on the containers. Operate in a well-ventilated place.

- Never use fuel for cleaning purpose. Always use non-inflammable solvent.
- Please open doors and windows for thorough ventilation during the handling of fuel and the cleaning of oil stain or paint.
- Preserve all inflammable liquids and materials in a safe and well-ventilated place.
- The short-circuit of electric system will probably result in fire. Daily check the wire connections for looseness and damage. Re-tighten loose connectors and cable clamps. Repair or replace damaged wires.
- Fire accident caused by pipelines: Ensure that the clamps, protection devices, and cushion pads of hoses and pipes are securely fixed. In event of looseness, the hoses and pipes will be damaged due to vibration or contact with other parts during operations. This will probably result in spray of high pressure oil to cause fire accident or harms.

Toxic Exhaust Gas from Engine



- Do not operate the engine in an enclosed place with poor ventilation.
- If the natural ventilation is not possible, install ventilation fan, fan, extended exhaust pipe, or other ventilation device.

Handling of Asbestos Powders

The inhalation of asbestos powders will probably cause lung cancer. While handling the materials probably containing asbestos, take the following safety measures:

- Do not sweep by compressed air.
- Avoid polishing or grinding asbestos-contained parts.
- During cleaning, use a vacuum device installed with high-efficiency particulate air filter (HEPA).
- If there is no other method for control of powders, please wear the specified respirator. During indoor operations, please install a ventilation system with polymer filter.



- During operations, the non-authorized personnel are prohibited to access the working zone.
- Please strictly abide by the rules and environmental standards applicable for this working zone.

Be careful to avoid crushing or cuts



Never place your hand, foot, or other body parts between the superstructure and chassis or tracks, between machine body and working device, or between cylinder and motion parts. During movement of machine, these clearances will change to probably cause serious injuries or deaths.

Use of Accessories

- Please consult with Ken stone company before installing accessories. Based on the attachment types and their combinations, the attachments will probably come into contact with the cab or other machine parts. Before use, ensure that the installed accessories will not come into contact with other parts.
- Do not use any attachment not approved by Ken stone company. Otherwise, it will probably endanger the safety or cause adverse influence on operations or life of machine.
- Ken stone company will not be liable for any injury, accident, or product damage arising from the use of non-approved attachments.

No Modification to Machine

The non-authorized modifications to the machine will cause injuries or deaths. All non-authorized modifications are prohibited for any part of machine.



Precautions during Preparations

Understanding of working zone

Before starting operations, understand the situation of working zone to ensure safety.

- Check the terrain and ground situation of working zone. For indoor operations, check the building structure and when necessary take safety measures.
- Ensure to keep away from dangers and obstacles such as water ditch, underground pipelines, trees, cliffs, overhead cables, and roads with falling stone or landslide danger.

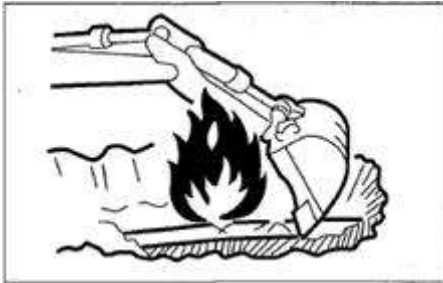

- Check the positions of underground gas pipelines, water pipelines, and electric cables together with administrator. If necessary, discuss with administrator to determine the detailed safety measures to be taken to ensure safety.
- During operations on road, ensure to take the safety of pedestrians and vehicles into

consideration.

- Use a signaler and/or signals.
- Isolate the working zone against the access of non-authorized personnel.
- Before operations in water or driving through shallow rivers, check the water depth, ground firmness, and flow rate in advance.

Understand more operation description information with reference to the “Precautions during Operations”

Checking of Bridge Strength

Please check the permissible load before driving on bridges or structures. If the strength is insufficient, reinforce the bridges or structures.

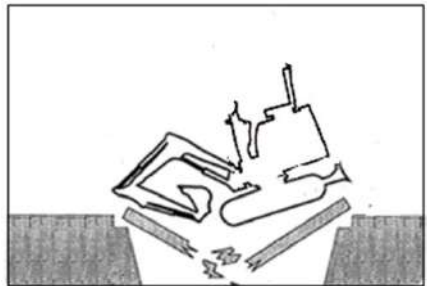



Always Keeping Clean Machine

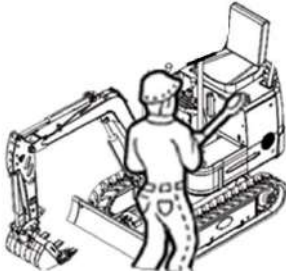

- Eliminate all loose objects and unnecessary devices in the machine.
- Wipe away lubricating oil, grease, mud, snow, and ice, in order to prevent accident due to slip.
- Remove dusts, lubricating oil, and grease from engine portion to prevent fire accident.
- Clean the area around operator's seat and remove all unnecessary objects from the machine.

Daily Checking and Maintenance

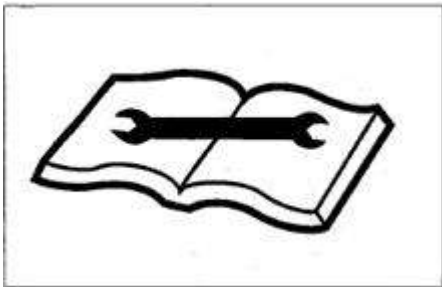

The failure to find out or repair the abnormalities or damages of machine will cause accidents.

- Before operations, fulfill the designated checking and when necessary repair immediately.
- In event of operation failure due to malfunction or engine malfunction, immediately stop the engine as per stop procedure and park the machine securely, till the malfunction is repaired.

Precautions in the driver's cabin

If the machine is equipped with a driver's cab:

- Before entering the driver's cab, please remove the dirt and grease from the soles of your shoes. Operating the machine pedal with dirt and grease adhering to the sole can cause an accident due to slipping under your feet.
- Do not place parts or tools around the driver's seat.
- Do not place any plastic bottles in the cab or install any suction cups on the window glass. The plastic bottle or suction cup acts as a lens and may cause a fire.
- Do not use your mobile phone while walking or working.
- Do not bring combustibles or explosives into the operation area.
- Do not leave the lighter in the driver's cabin. When the room temperature rises, the lighter may explode.



Safety

Safety Measures at Start

Safety measures when starting

Support your body weight by three-point safety posture while getting on/off the machine.

- Do not jump on or off the machine. Do not attempt to get on or off a moving machine.
- Before getting on or off the cab, firstly open the door completely to locking position and check and ensure that the door can't move further(For machine with cab).



- Face towards the machine, get on/off the footplates, and grab the handrail to support your weight by three-point safety posture (Hands and feet).
- Do not use safety lock handle or any joystick as handrail.

Before starting machine, keep all non-authorized personnel away from this zone

Start the engine only after the safe start is confirmed by checking the following items.

- Walk around the machine and alert the repair personnel and the personnel walking

around the machine. Start the engine only after it's confirmed that there is no person around the machine.



- Check for warning sign "No Operation" or similar sign affixed on cab door, control, or starter switch. If present, do not start engine or touch any joystick.
- Sound the horn to alert the personnel around machine.

Sit in the driver seat and start the engine.



- Adjust the seat till it's securely locked.
- Fasten the seat belt.
- Check whether the parking device is



Safety

Safety Measures at Start

actuated and all joysticks and pedals are in neutral.

- Check whether the safety lock handle is at locking position.
- Ensure there is no person near the machine.
- Start and operate the machine only in driver seat.
- Do not attempt to start the engine by short circuiting the terminals of starter device.

Start by Jumper Cable

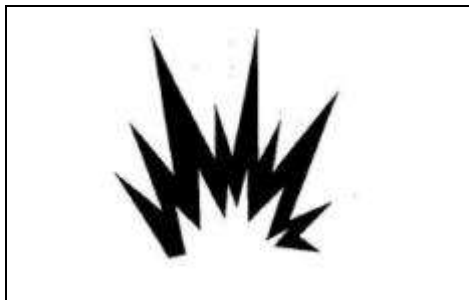

Start by jumper cable only as per the recommended method. The improper use of jumper cable will result in battery explosion or unexpected machine motions.

Please refer to “In event of no battery power” to understand more operation description information.

After Start of Engine

After the start of engine, fulfill following operations and checking in a place without personnel or obstacle. Upon detection of any malfunction, stop the engine as per the

procedure and report malfunction.

Warm up the engine and hydraulic oil.

Check all instruments and warning devices for normal functioning.

Check for presence of noise.

Test the engine speed control.

Operate all control devices to ensure normal functioning.

For Cold Weathers



Take cautions that the frozen ground, footplates, and handrails are slip. Under cold weathers, do not touch any metal part of machine by bare hands. Your skin will be frozen on metal part to cause serious injuries.

Do not use ethyl ether or starting fluid on the engine. The starting fluid can cause explosion and serious injuries or deaths.

Warm up the engine and hydraulic oil.

Operating joysticks without warm-up will result in slow or inappropriate reaction or movement of machine to cause accident.



Operation Precautions

Operating Machine with Maximum Track Width

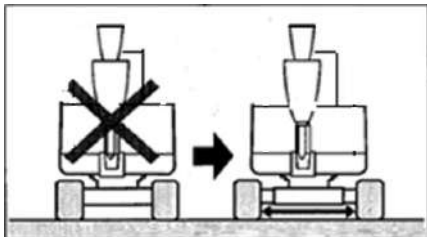

Always operate the machine with extended track width of 950mm, in order to improve the machine stability to the maximum extent.

Operating the machine with narrow track width (800mm) will probably result in rollover of machine due to poor stability.

If it's necessary to operate the machine with narrow track width (800mm), retract the bucket working device and lower the boom to reduce the gravity center and face the machine towards front before traveling.

Guarantee of Good Visibility

Checking of Visibility before Operations of Machine

During operations in a dark place, turn on the working lamp and headlamp of machine and when necessary install additional lighting devices. In event of poor visibility due to severe

weathers (Such as fog, snow, rain, and haze), stop the operations of machine till the visibility turns good.

Clean the windows, mirrors, lamps, and camera to keep good visibility. Adjust the mirrors and camera to optimal positions to ensure that the driver sitting in the driver seat can see the rear view (Blind spot).

The non-authorized modification or the installation of non-approved attachments will probably impair the visibility. The operator's visibility must conform to the requirements of ISO 5006.

Do not carry people on the machine



All personnel are prohibited to sit on any part of machine at any time during traveling or operations of machine.



Checking for Safe and Reliable Working Zone before Operations

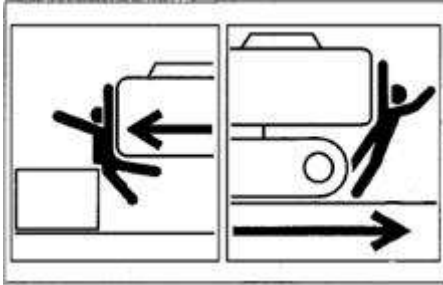

Verify the performance limits of machine.

Set up a signaler at the road shoulders, narrow places, or vision-obstructed places.

Do not allow any person to access the turning radius or path of machine.

Sound the horn to indicate your movement intention.

There are blind zones behind the machine.

Before driving backward, check the safety in the area behind machine and ensure there is no person behind the machine.

Checking of Chassis (Tracks) before Traveling

before Traveling

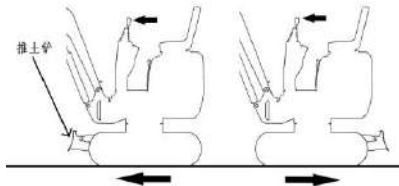

Before operating the traveling joystick/pedal, ensure that the bulldozing blade is in front of the driver seat. Please bear in mind that the operation direction of the traveling joystick/pedal with bulldozing blade behind the driver seat is reverse to that with bulldozing blade in front of driver seat.

Safe Traveling

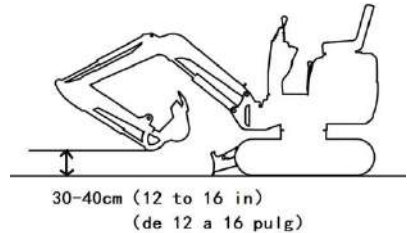

The bulldozing blade shall be lifted during traveling. Retract the bucket working device as shown in above diagram and lift the bucket by 30~40cm off the ground.

Do not slew during the traveling. If it's necessary to operate the bucket working device during traveling, operate at sufficiently low speed to ensure the complete control at all times.

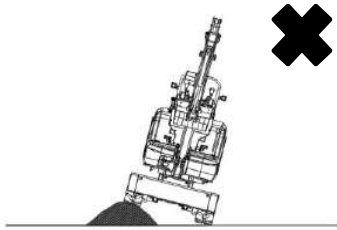

- Avoid driving over obstacles whenever possible. If it's necessary to drive over obstacles, keep the bucket operating device near the ground and travel at low speed. Do not drive over any obstacle that will incline the machine by 10° or larger.
- On rugged roads, drive the machine at low speed and avoid the sudden startup, stop, and direction change. Otherwise, the working device will probably come into contact with the ground to cause unbalance and damage of machine or destruct the structure in surrounding area.

Precautions for Traveling on Slopes

While traveling on slopes, take cautions to prevent the rollover and gliding of machine.

- Do not drive the machine on a slope steep enough to cause instability of machine. Please be noted that, in the actual applications, the performances of machine on a slope will be deteriorated due to severe working conditions.

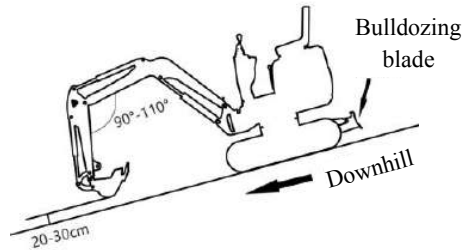

- Keep the driver seat facing towards the up slope direction while climbing up a slope. Keep the driver seat facing towards the down slope direction during down slope traveling. In both cases, pay special attention to the ground ahead of the machine during traveling.

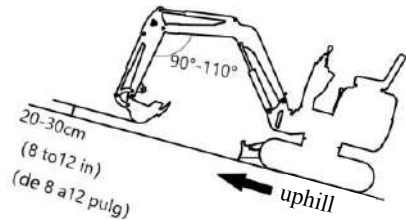

- While traveling on a slope, lower the bucket to 20~30cm off the ground. While climbing up a steep slope, extend the bucket working device to the front position. In event of an emergency, lower the bucket onto the ground and stop the engine of machine.
- When walking on slopes or ramps, drive slowly. Reduce engine speed when going downhill.
- Do not reverse the machine down a slope.

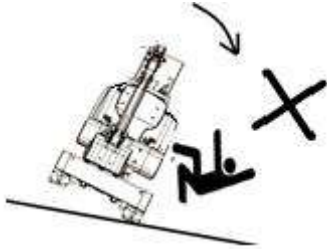

- Do not change direction on slopes or cross slopes. First return to the flat surface, and then take another path.
- When walking on a gentle slope covered with grass or dead leaves, or when walking on wet metal plates or frozen ground, the machine may slip. Make sure that the machine does not stop laterally on a slope.
- If the machine stalls on a slope, return the operating levers to the neutral position, and then restart the engine.

Special Cautions for Operations of Machine on Ice/Snow

- While traveling on snowy or icy roads, drive at low speed and avoid the sudden startup, stop, and direction change.
- In snowy regions, the road curbs and the roadside objects are buried in the snow to become invisible. In addition, there is a danger of machine rollover or collision with covered objects. Therefore, always operate with cautions.
- There is a danger of rollover or snow entrapment while driving the machine into thick snow. Drive with cautions and do not drive over road curbs or entrap in the snow.
- For frozen soil surface, the ground becomes soft when the temperature rises, which will probably result in rollover of machine and entrapment of operator in the machine.
- While parking the machine on a unstable ground, lower the bulldozing blade.



No Movement of Bucket over Personnel

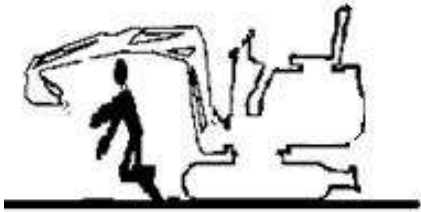

Moving the bucket over the personnel has a danger of splashing of loaded material or the sudden falling of bucket.

Guarantee of Driver's Safety during Loading

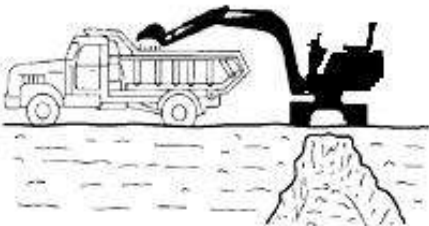

Do not load before the driver reaches a safe place.

- Do not swing or position bucket above personnel or cab.
- Load from the back door of trucks.

Keeping a Safe Distance from Overhead High-Voltage Cables

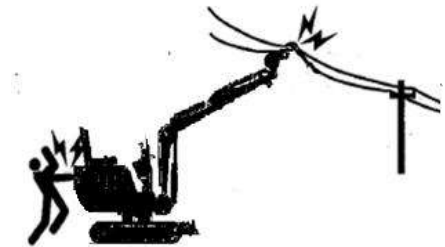

Never close any part or loaded material of machine to high-voltage cables, unless all safety measures specified by local and national authorities are already taken. There is a danger of electric shock and death when any person approaches to the machine that is discharging electric spark or is near or in contact with power supply.

- Always keep a safe spacing between machine and high-voltage cables.
- Before starting operations, please verify the relevant operation safety procedures with local power grid.
- Consider all electric cables as high-voltage cables. Even if it's known or believed that the power supply is cut off or the cable is clearly grounded, consider such cables also as live cables.
- If the machine is too close to high-voltage



Safety

Operation Precautions

cables, set up a signaler to sound warnings.

- Keep all personnel within operation zone away from machine and loaded material.
- Pay special attention to the underground high-voltage cables.



Close Observation on Dangerous Working Conditions

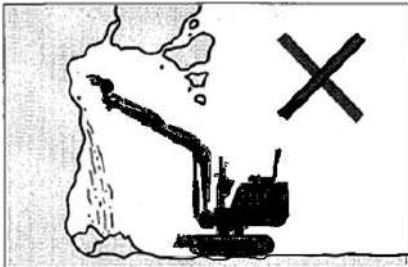

- Never dig on the bottom of any high embankment. It's really dangerous because such operation will probably result in surface collapse.
- Do not operate in any place with falling stone danger.

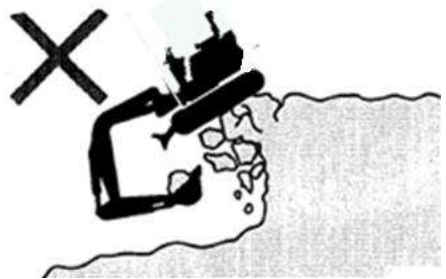

- Keep a safe spacing between machine and edge of digging site. Do not dig the ground ahead of machine.
- During the operations near a cliff or road curb, to ease the escape in any event, form a right-angle between tracks and cliff or road curb and place bulldozing blade in the front.

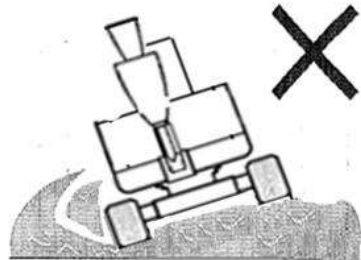

- Do not access any soft ground area. This will probably result in inclination of machine due to dead weight to cause rollover or ground entrapment.

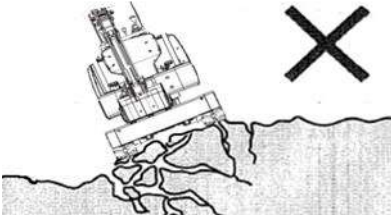

- Keep away from unstable ground (Cliffs, road curbs, and deep ditches). If the ground collapses due to machine weight or vibration, there is a possible danger of machine falling or rollover.
- Please bear in mind that the soil turns infirm after heavy rain or explosion.
- The ground on the top of embankment and the ground around and on top of the dug ditches are also infirm.

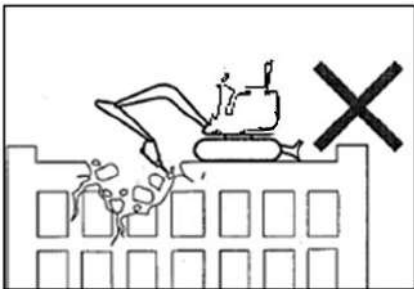

- Do not perform demolition operations beneath the machine. There is a possible falling danger of machine when the ground becomes unstable.

- Before the operations on the top of any building or other structure, check the strength and structure. It will cause serious harms or destruction if the building or structure collapses.

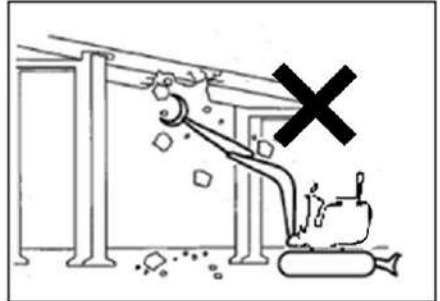

- Do not perform demolition operations above your head. There is a falling damage of damaged parts or collapse danger of building to cause serious harms or destruction.

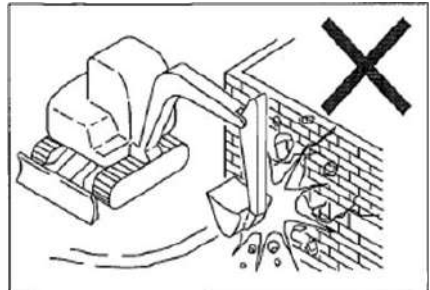

- Do not perform the demolition operations by the impact force of bucket working device. The splashed material fragments and the damaged bucket working device have a danger of serious harms.



Danger during Operations on Slopes

During operations on slopes, slewing or operating the working device can probably result in instability or rollover of machine.

Avoid operations on slopes whenever possible.



- Leveling operation zone

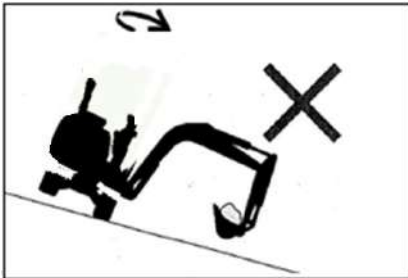

- If the bucket is fully loaded with material, avoid slewing towards the down slope direction. Otherwise, it will deteriorate the machine stability and probably result in rollover.

No Lateral Slewing (Swing) with Bucket Heavily Loaded

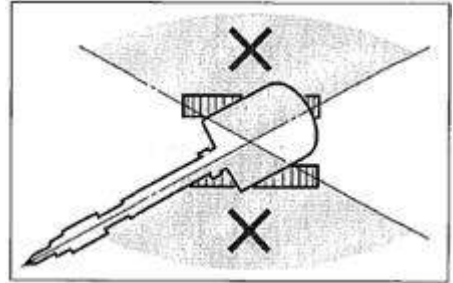

The machine is more vulnerable to rollover in lateral direction than longitudinal direction.

- Do not laterally slew (swing) when the bucket working device is heavily loaded. Especially, do not laterally slew (swing) on a slope.
- When the machine is equipped with breaking hammer, grinder, or extended bucket arm, the attachment end is heavier than that with standard bucket. For machine with such heavy end, do not face the bucket arm (boom) towards down slope direction for digging or towards lateral direction for operations.



Please pay attention to the objects above your head

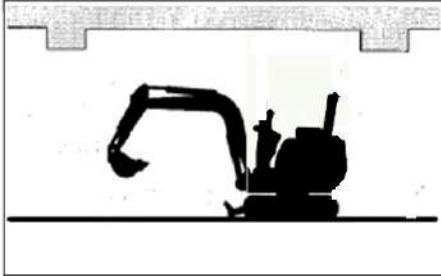

During operations under bridges, in tunnels, near cables, or indoors, guard the boom and bucket arm against impact with any overhead object.

Not Designed for Lifting Application



This machine is specially designed for digging operations. Therefore, it's not installed with safety devices for lifting operations. Take special cautions while using this excavator for lifting operations.

- Do not overload during lifting. The overload will result in rollover of machine to cause

serious injuries or deaths.

- All rated lifting capacities are based on the condition of using this machine on a firm and level ground. The user's is recommended to reserve an appropriate allowance for specific working conditions, in order to ensure the safe lifting operations. The soft or uneven ground, non-level status, lateral load, dynamic or sudden load, dangerous environment, and personnel experience are included. Before operating the machine, the operation personnel and other personnel shall be really familiar with the Operation Manual. The safe operation regulations of the machine shall be strictly followed in all cases.
- If the chain or lifting device is incorrectly connected, the bucket connecting rod or the lifting device will probably fail to cause serious injuries or deaths.
- While using this machine as a crane, do not attempt to pull out a stump from the ground. For this application, the load applied onto the machine is completely unknown.
- Do not allow any person to stand on or beneath the lifted object or close to the operation zone.

Please pay attention to flying objects

This machine is not installed with any protective device to guard the operator against the harms of flying objects. Do not operate this



Safety Operation Precautions

machine in any dangerous place in which the operator is probably subject to the impact of flying objects.

Please refer to the section “Towing” to understand more description information.

Precautions for Towing

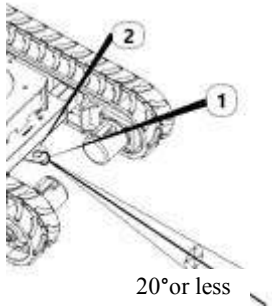

During towing, the improper operations, the incorrect use of rope, or the improper checking will cause serious injuries or deaths.

- The breakage or cracking of rope can cause danger. Use wire ropes compatible with the towing force.
- Do not use any kinked, twisted, or even damaged rope.
- Do not suddenly apply heavy load onto the rope.
- Please wear safety gloves during the handling of rope.
- Ensure that an operator is assigned each on the towing machine and the towed machine.
- Do not operate the towing operation on a slope.
- Keep all personnel away from the rope during towing.



Precautions for Parking

Safe parking

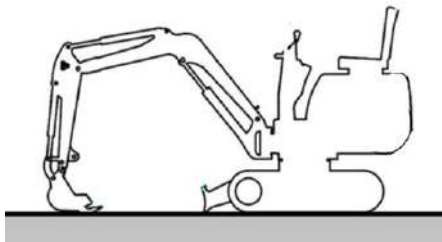

- Stop the machine on a level, solid, and safe ground. Set the parking device.

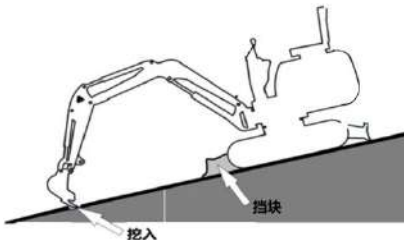

- If it's necessary to park the machine or tilt the machine on a slope, securely park the machine and block the machine against movement.

While parking the machine in a street, use gratings, warning signs, or lamps to keep the visible even in the night, in order to prevent the impact with other vehicles.

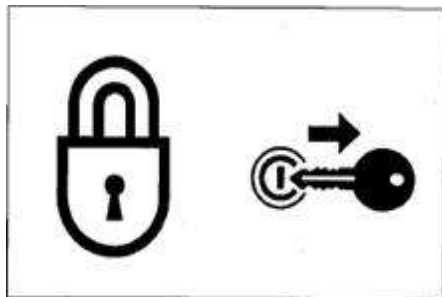

- Complete the following operations before leaving the machine:
Lower the bucket and bulldozing blade onto the ground.
Lift up the safety lock handle to the locking position.
Stop the engine and withdraw the starter key.
Lock the cab and hood and carry the key with you.



Precautions during Transport

Safe loading/unlocking of machine

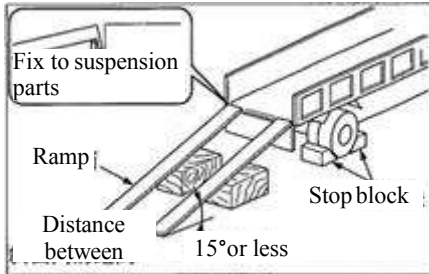

The machine will probably roll over or fall off during loading and unloading. Ensure to take the following safety measures:

Select a solid and level ground and keep a sufficient spacing from the road curb.

Fix the ramps of sufficient strength and dimensions to the cargo body of truck. The inclination of the ramps shall not exceed 15°. If the ramps deflect downward excessively, please support the ramps by supports or cushion blocks.

Do not load or unload the machine by working device. Otherwise, it will probably result in rollover or falloff of machine.

Keep the truck cargo body and the ramps clean without oil, sand, ice/snow, or other impurity, in order to prevent the side slip of machine. Clean the tracks.

Block the wheels of transport truck by wedges

to prevent movement. While loading or unloading the machine, drive the machine slowly in 1st gear (low speed) as per the signals of the signaler.

Do not change direction on ramps.

Do not slew/swing on ramps. Otherwise the machine will probably roll over.

Slewing (swinging) the machine on the cargo body of truck will probably result in unstable legs of machine. Therefore, operate slowly.

If possible, lock the cab doors after loading.

Otherwise the cab doors will probably open during the transport.

Plug securely the tracks by wedges and then fix the machine to the truck cargo body securely by ropes or chains.



Safe Lifting of Machine

Master and utilize the correct lifting gestures.

Daily check the lifting device for damaged and missing parts and when necessary replace.

Please use the ropes of sufficient capacity for the machine weight during lifting.

Lift the machine as per the procedure described below. Do not operate by any other method, otherwise it will probably result in unbalance of machine.

Please refer to the section “Lifting of Machine” to understand more description information.

Do not operate the lifting if there is any operator on the machine.

Operate slowly during lifting to prevent the rollover of machine.

During lifting, keep all personnel away from working zone. Do not move the machine over any person.

Safe Transport of Machine

During the transport of machine, understand and abide by all applicable safety rules, vehicle codes, and traffic regulations.

Take the length, width, height, and weight of the transport truck with loaded machine into consideration, in order to select the best transport route.

During the transport, do not start up or stop the transport truck suddenly or drive at high speed.

Otherwise, it will result in movement or unbalance of loaded machine.



Precautions for Maintenance

Warning Information of “No Operation” Sign

During the checking or maintenance of machine, the start of engine or the touch of any joystick by non-authorized personnel will probably result in serious injury accidents. Before maintenance, please stop the engine and withdraw and carry the key.



Affix warning information “No Operation” to an eye-catching place such as starter switch and joystick.

Use of Correct Tools



Do not use any damaged or deteriorated tool or any tool designed for other application. Use tools suitable for related operations.

Periodically Replaced Critical Safety Parts

Replace the fuel hoses periodically. The fuel hoses will wear gradually along with time, even if no wear symptom is visible.

Upon detection of any wear symptom, replace the fuel hose, regardless of the replacement schedule.

To understand more details, please refer to the section “List of Critical Safety Parts”.

Explosion-Proof Lamps



While checking the fuel, lubricating oil, coolant, and battery electrolyte, please use explosion-proof lamps to prevent fire and explosion. Otherwise, it will probably result in explosion to cause serious injury accidents.



No Access of Non-Authorized Personnel

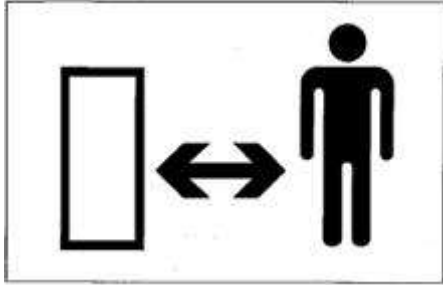

During operations, the non-authorized personnel are prohibited to access the working zone. Take cautions during grinding, welding, and use of hammer. You will probably be injured by the flying fragments from the machine.

Preparations of Working Zone

Select a stable and level working zone. Ensure the appropriate illumination conditions. For indoor operations, keep well ventilated. Remove obstacles and dangerous goods. Clear slippery areas.

Always Keeping Clean Machine

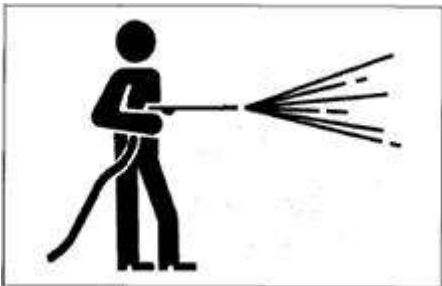

Please clean the machine before maintenance. Stop the engine before cleaning the machine. Cover the electric parts against water ingress. The water ingress into the electric parts will probably result in short-circuit or malfunction. Do not clean the battery, electronic control units, sensors, connector, or cab by water or steam.

Stop of Engine before Maintenance

While the machine is working or the machine is not working but the engine is running, avoid lubricating or further adjusting the machine. If the maintenance requires the running of engine, assign two operators for teamwork and keep contact with each other.

One operator must sit in the driver seat to get ready to stop the engine immediately when necessary. This operator must pay special attention not to touch any joystick or pedal, unless it's absolutely necessary.

The other operator for the maintenance must keep the body and clothing away from motion parts of machine.



Safety

Precautions for Maintenance

Keeping Away from Motion Parts



Keep away from all rotating and motion parts. The entanglement of hands or tools into rotating or moving parts will probably cause accidents of serious injuries or even deaths.

The tools or other objects fallen or inserted into the fan or fan belt will be crushed or cut. Never throw or insert any object into fan or fan belt.

Secure Fixing of Machine and Possibly Falling Parts



Before the maintenance or repairs beneath the machine, lower all movable working devices onto the ground or lowest position and fix the

tracks.

If it's necessary to operate beneath the lifted machine or device, always fix by cushion woods, jack, or other firm and stable supports. Do not access the area beneath the machine or working device before it's firmly supported. This operation is especially important for the hydraulic cylinder operations.

Fixing of Working Device

During the repairs and replacements of bucket teeth or side teeth, to prevent the accidental movement of machine, securely fix the working device.

Steady Placement of Opened Engine Hood and Cover

Before operations within the machine, please securely fix the engine hood or machine hood. Keep the engine hood or cover closed under windy weather or while parking the machine on a slope.

Placement of Heavy Weights at Steady Place



If it's necessary to place temporarily heavy



Safety

Precautions for Maintenance

weights or attachments onto the ground during disassembling or installation, please ensure to place them in a steady place. Keep the non-authorized personnel away from the place for storage of such objects.

Precautions for Refueling



The smoking and open fire are prohibited during refueling and near the refueling point. Do not disassemble the fuel tank cap or refuel while the engine is running or is not cooled down. Do not splash fuel to any high temperature surface of machine. Refuel the fuel tank in a well-ventilated place. Do not top up the fuel tank. Leave an expansion space for the fuel. Any overflow fuel shall be wiped away immediately. Tighten the fuel tank cap securely. If the fuel tank cap is missing, replace with original cap only. The use of non-authorized fuel tank cap with poor ventilation will cause internal

pressure in the fuel tank.

Do not use fuel for any cleaning purpose.

Use correct fuel grade based on the season.

Handling of Hoses

The leakage of lubricating oil or fuel can result in fire accident.

Do not distort, bend, or impact any hose.

Do not use any distorted, bent, or cracked pipeline, metal pipe, or hose, otherwise it will probably result in burst.

Re-tighten any loose connector.

Absolution Caution during Handling of High Temperature and High Pressure Parts

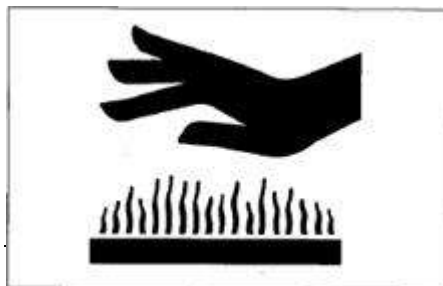

Please stop the engine and wait for the machine to cool down before maintenance.

The engine, exhaust pipe, radiator, hydraulic pipes, sliding parts, and many other machine parts are really hot when the engine is just stopped. Touching such parts can cause scalding. The engine coolant, hydraulic oil, and other



Safety

Precautions for Maintenance

fluids are also under high temperature and high pressure status.

Take cautions not to touch the hydraulic oil while loosening engine hood or connector.

Operating the machine under such condition will cause out-spray of hot oil to result in scalding or injuries.

Absolution Caution during Handling of High Temperature and High Pressure Parts



Do not disassemble the radiator cap or drainage plug when the coolant is hot. Stop the engine and wait for the engine and coolant to cool down. Slowly loosen the radiator cap to relieve the internal pressure and then take it out.

Caution against Internal Oil Pressure

Take caution against internal oil pressure. After the stop of engine, the pressure in the hydraulic oil pipes can hold for a long time.

Before the maintenance, thoroughly relieve the internal pressure.

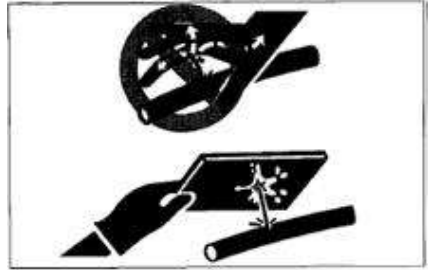

The high pressure of hydraulic oil can penetrate skin and eyes to cause serious injuries and blindness or even death. Please bear in mind that the hydraulic oil permeating from orifices is nearly invisible to naked eyes. While checking for leakage, wear goggles and thick gloves and protect the skin by paper boards or plywood to protect against the harms of spraying hydraulic oil.

The hydraulic oil penetrating into your skin must be cleared by a doctor familiar with such injuries with surgical method within several hours.

Pressure Relief before Operations of Hydraulic System

Disassembling cap or filter or disconnecting pipeline before the pressure relief of hydraulic system will probably result in out-spray of hydraulic oil.

- Slowly loosen the bleeding plug to relieve the pressure of oil tank.



Safety

Precautions for Maintenance

- While disassembling connector or plug or disconnecting hose, stand on one side, loosen slowly to gradually relieve internal pressure, and then take out.
- The engine oil or oil plug will probably spray out under the internal pressure of traveling motor oil tank. Please slowly loosen the oil plug to relieve the internal pressure.

Guard against Splashed Fragments during Use of Hammer

During the use of hammer, the pins and the metal fragments will probably fly out. It will probably cause serious personal harms.

- While hammering hard metal parts such as pins, bucket teeth, side teeth, and bearings, please wear protective articles including goggles and gloves.
- While hammering pins and bucket teeth, ensure there is no person in surrounding area.

Guard against High Pressure Grease



In the track pensioner, the grease is injected under high pressure. If the tension is not adjusted by the following designated procedure, the grease relief valve will probably fly out to cause injuries.

- Never loosen the grease pipe fittings.
- Slowly loosen the grease relief valve. Do not rotate it for >1 turn.
- Do not place your face, arms, legs, or body in front of the grease relief valve.
- If no grease flows out when the grease relief valve is loosened, the valve is malfunctioned. Please contact a Ken stone Heavy Machinery service dealer for repairs.

No Disassembling of Track Pensioner

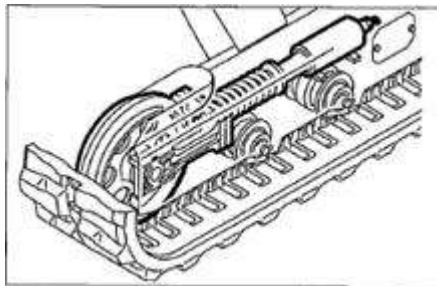

The track pensioner is installed with a high strength spring. If the track pensioner is disassembled carelessly, the spring will spring out to cause serious injuries. Do not disassemble the track pensioner.



Operations of Additional Devices



Take special cautions while handling the high pressure nitrogen stored in the tank. The improper handling will probably result in explosion of nitrogen to cause serious injuries. Please strictly abide by the following safety measures:

- Do not break up or disassemble.
- Keep away from open fire and fire source.
- Never drill hole, weld, or melt.
- Guard against physical vibration, such as hammering, rolling, and falling.
- Bleed the sealed air before handling the cylinder body. If you need help, please contact a Ken stone Heavy Machinery service dealer.

Disconnection of Battery Cables



Please disconnect the battery cables before operations or electric welding of electronic system. Firstly disconnect the negative (-) cable of battery. During re connection, finally connect the negative (-) cable of battery.

Caution during Handling of Battery

- The battery contains sulfur acid. The accidental touch will harm your eyes or skin.
 - In event of accidental contact with eyes, immediately flush by clean water and quickly seek for medical treatment.
 - In event of accidental swallowing, drink a lot of water or milk and immediately seek for medical treatment.
 - If the sulfur acid comes into contact with your skin or clothing, immediately flush by a lot of water.
- Wear goggles and gloves during handling of battery.



Safety

Precautions for Maintenance

- The battery can generate inflammable hydrogen to probably cause explosion. Keep away from fire sources including open fire, spark, and ignited cigarette.
- Use a flashlight to check the electrolyte level.
- Ensure to turn off the starter switch and stop the engine before checking or handling battery.
- Never touch the electrodes by any metal tool or object, in order to prevent short-circuit.
- The loose electrodes can generate electric spark. Ensure to tighten any loose electrode.
- Ensure that the battery cover is securely covered.
- If the battery is frozen, do not charge the battery or attempt the jumper start of engine, otherwise it will probably cause explosion. Before use, heat the frozen battery to 15°C.
- Do not use the battery when the electrolyte level is below the lower limit. Otherwise it will speed up the internal aging and shorten the life of battery. In addition, it can lead to burst (explosion).
- Do not fill the distilled water till the level is above the upper limit. Otherwise the electrolyte will leak out. The contact with such electrolyte can harm your skin or corrode the machine parts.
- Clean the surrounding area of electrolyte level marking by a wet cloth and check the level. Do not clean by a dry cloth, otherwise it can cause electrostatic accumulation and combustion or explosion.

Periodically Replaced Critical Safety Parts

- To guarantee the safe operation of machine for a longer time, add the oil and fulfill the checking and maintenance periodically. To promote the safety, periodically replace the critical safety parts, including hoses and seat belts. To understand more details, please refer to the section “Periodically Replaced Critical Safety Parts”.
- “Periodically replaced critical safety parts” refers to the parts aged, worn, and functionally deteriorated after repeated use. The performances of such parts will change along with time. These characteristics of such parts can cause serious mechanical damages or personal harms and the remaining lives of such parts can't be judged by merely appearance checking or operation hand-feel.



- Upon detection of any visible damage on the appearance, please replace the “periodically replaced critical safety parts”, even if the designated replacement period is not reached.

Jumper Start with Battery Charging Cable

- To start the engine by battery charging cable, ensure to connect the cable correctly as per following procedure. The incorrect connection of cable can cause discharging and battery explosion.
- Keep the “Malfunctioned machine” and “Rescue machine” away from mutual contact.
- Never touch the positive (+) and negative (-) electrodes of battery charging cable with each other or with the machine.
- During connection, firstly connect the positive electrode of battery charging cable to positive (+) terminal. During disconnection, firstly disconnect the negative (-) terminal (grounding terminal) from the negative cable.
- Ensure to connect the cable clamps securely.
- Connect the last clamp of battery charging cable to a place as far as possible from the battery.
- To start the engine with battery charging

cable, always wear goggles and gloves.

- Use the battery charging cable and clamps of dimensions suitable to the battery capacity. Never use damaged or corroded battery charging cable or clamps.
- Ensure that the battery capacity is same for the “Malfunctioned machine” and “Rescue machine”.

Asking Ken stone Heavy Machinery Service Dealer for Welding Repair

The welding operations, if necessary, must be fulfilled by competent personnel in a working site with complete equipment. To prevent damaging any machine part by over-high current or electric spark, please abide by the following precautions.

- Disconnect the battery cables before electric welding.
- Do not apply 200V or higher voltage continuously.
- Connect the grounding point within 1m reach from the welding area. Do not connect the grounding terminal near the electronic control device/instrument or connector.
- Ensure there is no seal ring or bearing between welding area and grounding terminal.
- Do not connect the grounding terminal to



Safety

Precautions for Maintenance

the any place near the working device pin or hydraulic cylinder.

- Before the welding of machine body, disconnect the connector of electronic control device.

Vibration Applied on Operator

According to the results of the test on the vibration transmitted from the machine to the operator, the vibration applied on the operator's upper limbs is $<2.5\text{m/s}^2$ and the vibration applied on the operator's body in the seat is $<0.5\text{m/s}^2$.

Checking after Maintenance

- Accelerate the engine speed slowly from low idling speed to fastest speed and check for leakage of oil or water from repaired parts.
- Operate all joysticks and check machine for normal operations.

Waste Disposal



- Ensure to collect the drained oil of

machine into a container. The improper treatment of waste oil will pollute the environment.

- While disposing harmful objects, including lubricating oil, fuel, coolant, solvent, filter, and battery, please abide by the applicable laws and regulations.

Disposal of Harmful Chemicals

The direct contact with harmful chemicals will cause serious harms. The harmful chemicals used in this machine include oils/greases, battery electrolyte, coolant, paint, and adhesive. Please dispose the harmful chemicals carefully and properly.



Safety Signs

To guarantee the safety of operator and operation personnel in the working zone, please set up the following safety signs (markings) at some portions of machine. Walk around the machine with this manual and observe the contents and placement locations of these safety signs. Please review these signs and operation instructions contained in this manual jointly with the machine driver.

- The safety signs shall be clean, clear, and easily legible. If any safety label falls, is damaged, or becomes illegible, please replace with new one. Please provide your product serial number while ordering new signs from a Ken stone Heavy Machinery service dealer.
- If a part/body on which a safety sign is affixed is already replaced, affix a new sign to new part/body.



Safety Safety Signs

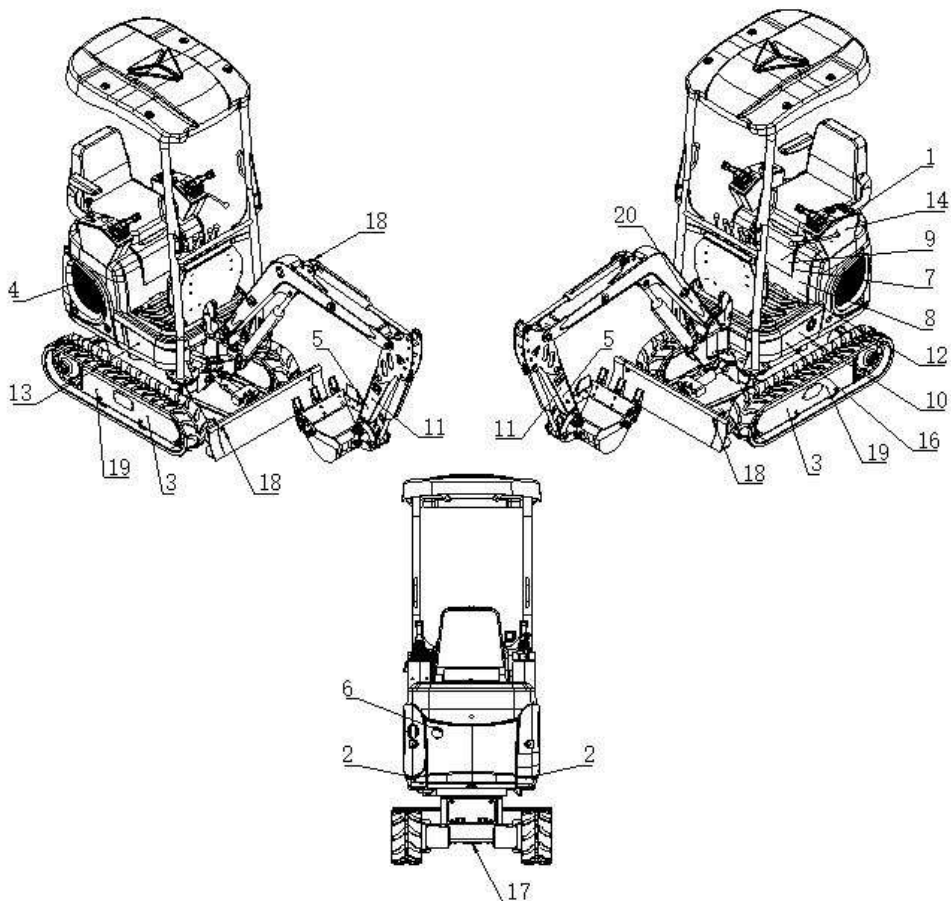



Safety Safety Signs

1. Warning

Carefully read and understand the manual before operations, checking, and repairs of machine.

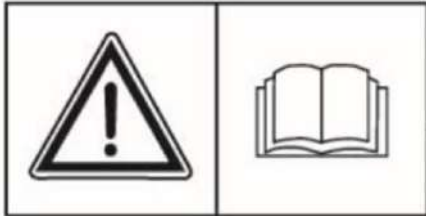

2. Safe distance.

Never approach to or stand in the working zone of machine.



3. Danger from underbody bolts thrown from track roller adjuster. To guarantee the safe and correct operations, ensure to read the operation manual before adjusting the track roller adjuster.



4. Risk from rotating parts. Please turn off before checking and maintenances.



5. Safe distance and danger from collision with working device. Please keep away from machine during operations.





Safety Safety Signs

6. This sign denotes not to touch any hot part during operations or just after operations. Do not touch before these parts, including engine, pump, and exhaust pipe, are cooled down.



8. This sign denotes that opening the radiator or hydraulic oil tank before its cools down will probably cause scalding risk by the spraying hot water or oil. Cool down the radiator or hydraulic oil tank before opening the cap.



7. This sign denotes that the entanglement into steering belt can cause injury danger. Ensure that the steering belt completely stops rotation before maintenance or repairs.



9.

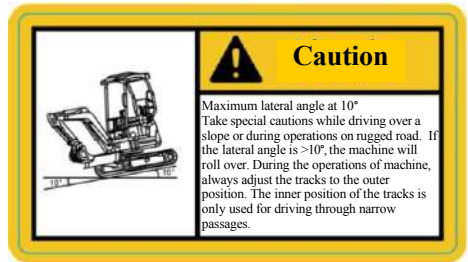



Safety Safety Signs

10.

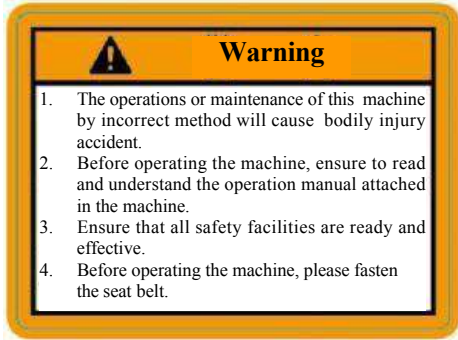

11.

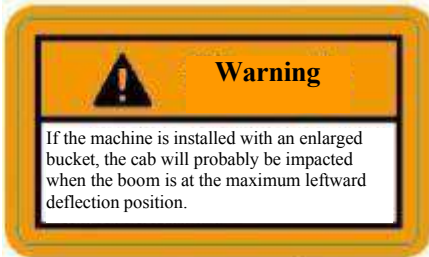

12.

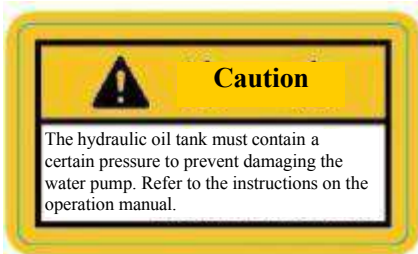

13. Diesel



14. It's prohibited to touch any joystick or traveling joystick while getting on or off the machine, otherwise the parts will be damaged.



15. There is a danger of electric shock during operations of cables.





Safety Safety Signs

16. Hydraulic oil



17. Fixed point

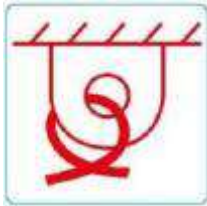

18. Lifting direction



19. When the machine is lifted, fix it by cushion blocks or supports. Do not operate beneath the lifted machine when the machine is not fixed by any support.

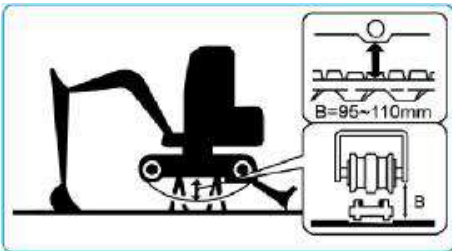

20. Keep the boom and bulldozing blade separated. While lowering the boom, take cautions not to touch the boom with bulldozing blade.



21. No people are allowed to stand in the working area





Safety Safety Signs

22、 Pay attention when relieving pressure



23、 Keep away from the engine fan



Controls





Control

Component Name

Component Name

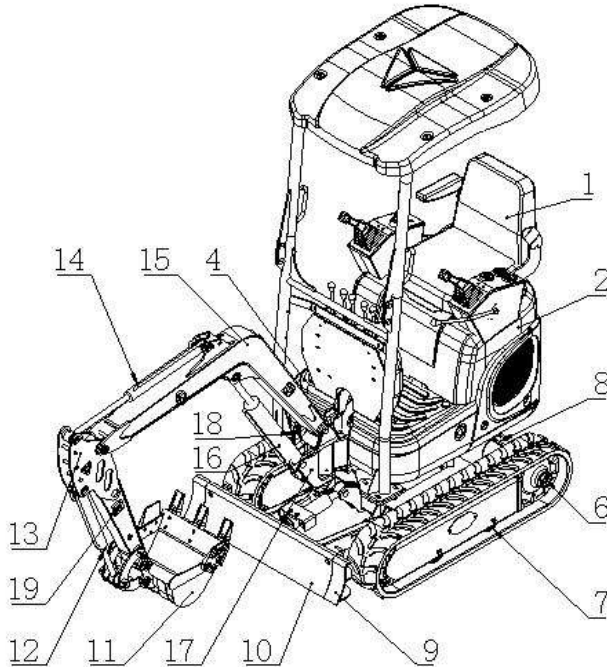

Up frame	Chassis	Working device
1、 seat	5、 Track	11、 Bucket
2、 Engine hood	6、 Drive wheel	12、 Bucket cylinder
3、 Hydraulic oil tank	7、 Track roller	13、 Arm
4、 Fuel tank	8、 Traveling motor	14、 Arm cylinder
	9、 Bulldozer blade	15、 Boom
	10、 Cylinder of blade	16、 Boom cylinder
		17、 Swing joint
		18、 Swing cylinder
		19、 Hydraulic circuit



Control

Component Name

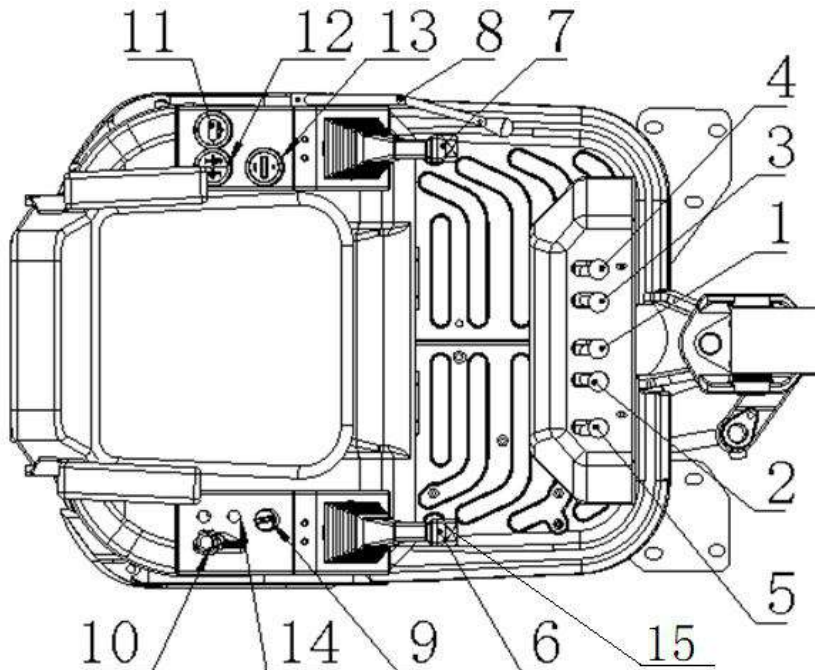

- | | |
|-------------------------------|---|
| 1. Left traveling lever | 8. Safety lock handle |
| 2. Right traveling lever | 9. Start switch |
| 3. Bulldozer blade lever | 10. Throttle lever |
| 4. Lever for telescopic track | 11. Water temperature meter |
| 5. Boom swing lever | 12. Warning sign |
| 6. Right joystick | 13. Hour meter |
| 7. Left joystick | 14. Lighting switch |
| | 15. Switch auxiliary oil circuit button |

The specific configuration depends on the machine specification or selected product.



Start Key



The start key is used to start the engine.

Repair cover (rear cover, hood, engine cover)



Warning

Before opening the repair cover, ensure that the safety lock handle is at locking position and the engine is stopped.

When opening or closing the service cover, please be careful not to pinch your hands or other parts of your body.

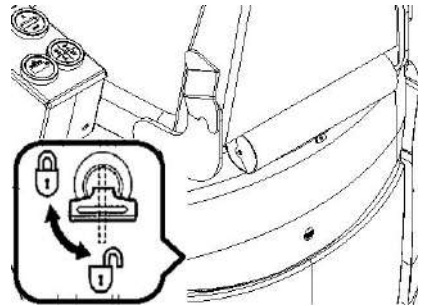

Opening

1. Insert the hood key and turn it counterclockwise to unlock the maintenance cover.
2. Lift the hood lock and lift the maintenance cover

Closing

1. Unlock the limit lever and close the maintenance cover.
2. Insert the hood key and turn it clockwise to lock the maintenance cover.



Control Cover

Fuse Case

This case is functioned to protect the electric system against over-current.

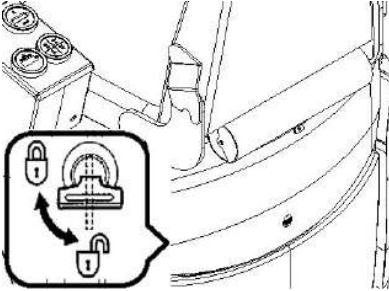

Open

1. Insert the hood key and turn it counterclockwise to unlock the maintenance cover.
2. Lift the hood lock and lift the maintenance cover.
3. Locate the fuse box.

Close

1. Unlock the limit lever and close the maintenance cover.
2. Insert the hood key and turn it clockwise to lock the maintenance cover.

Fuel filler port



Warning

- During the refueling into the fuel tank, keep away from heat source and open fire and do not smoke.
- Refuel the fuel tank in a well-ventilated place. Stop the engine before refueling.
- Any overflow fuel shall be wiped away immediately.
- Do not top up the fuel tank. Leave an expansion space for the fuel.
- Tighten the fuel tank cap securely.

Opening

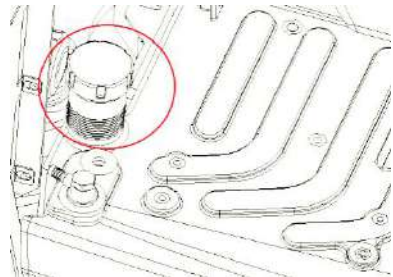

1. Insert the hood key and turn it counterclockwise to unlock the maintenance cover.
2. Lift the hood lock and lift the maintenance cover.
3. Hold the fuel tank cap and turn it counterclockwise to unlock the fuel cap.

Closing

Fasten the fuel tank cap and turn it clockwise to lock the fuel cap.



Seat



Warning

Adjustment and Fixing of Seats (For high-end seats only)



A. Adjust the backrest angle

1. Stand up straight and sit back on the seat.
2. Adjust the backrest to the angle you want by rotating the handle (1).

B. Front and back adjustment

1. Pull up the adjustment lever (2), slide the seat back and forth, and adjust it to the position you want when operating the machine.
2. Loosen the adjustment handle (2) at the position you want to fix the seat.

Records



Panel Name and Description

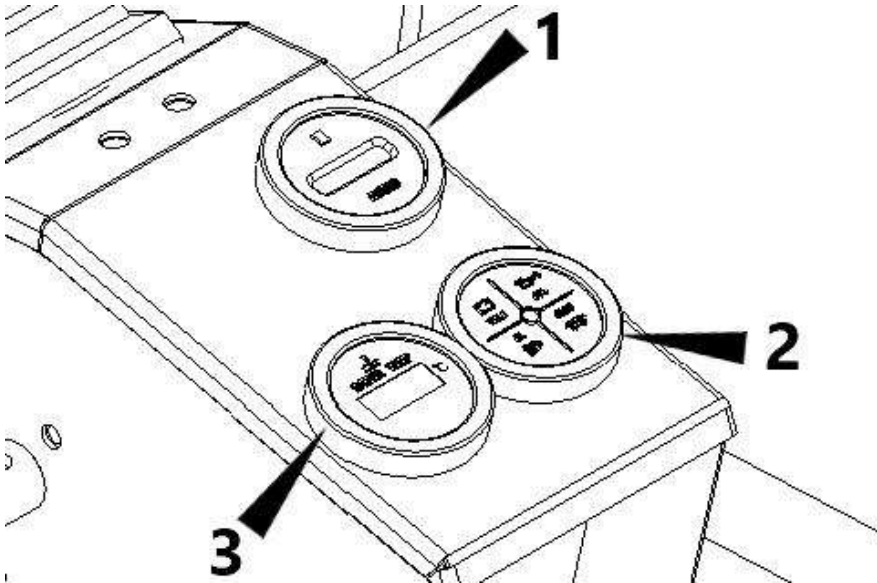

no.	name	note
1	hour meter	Display working hours, the range is 0-9999.9h.
2	Charging warning light	When the engine is running, if there is a problem with the charging system, the light flashes and an alarm sounds.
	Oil pressure indicator	When the engine is running, if the oil pressure is abnormally low, the light flashes and an alarm sounds.
	Work light indicator	Show the working conditions of the work lights.
	Warm-up indicator	When the engine is warmed up, the light goes out.
3	Water temperature meter	Shows the change of cooling water temperature.



Precautions

This instrument is a water-proof instrument, featuring stable performance and high conciseness and elegance, and is an intelligent instrument developed specially for small excavators. To guarantee the stable data and prolong the life of instrument, please notice the following issues:

1. Do not disassemble the instrument without permission.
2. Never brutally hammer or knock the instrument.
3. Guard against external damages.
4. Keep clean the panel. Any organic solvent or corrosive liquid, including diesel and gasoline, shall be timely wiped away, in order to prevent corroding the panel.
5. Should you have any question during use, please timely contact service personnel.

After-Service Information

Provided that the operations are performed normally as per the instructions of the manual, the malfunctions occurred within the warranty period will be repaired free of charge. Please carry this warranty certificate during the repair of this product and repair by a sales point of this device. The repair expense will be charged under the following conditions:

1. No warranty certificate.
2. Malfunction due to incorrect use of this device or non-authorized repair or modification of this device.
3. Malfunction due to falling at user's default during transport after purchase.
4. Malfunction due to fire, earthquake, gas leakage, windstorm, thunder and lightning, and abnormal voltage.
5. The purchase date or customer name is not recorded in this manual or the information is altered.



Control Switches

Start Switch

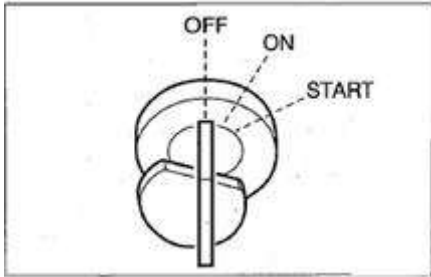

Important: Do not rotate the starter key from OFF to ON and then from ON to OFF repeatedly within a short time, otherwise it will probably result in engine malfunction.

OFF This position is used to stop the engine and insert and withdraw the starter key.
ON Engine running position. All electric devices are functional at this position.
START Engine running position. Upon release of key, the switch automatically returns to ON.

If the coolant temperature is too low, rotate counter-clockwise the key, hold for 10~15s, and then release before start. Rotate the key to ON and then to START to start the engine.

Horn button

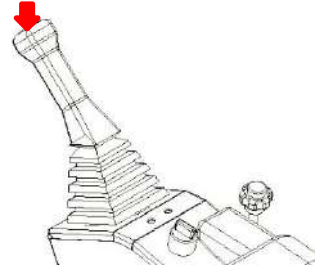



Joysticks

Safety lock handle



Warning

- Before standing up from the driver seat to adjust the operator's seat, lower the working device to the ground, lift up the safety lock handle to lock it, and stop the engine. When the safety lock handle is lowered down (Unlocked), the accidental touch of any joystick will result in sudden movement of machine and cause serious injuries or deaths.
- Please be noted that, even if the safety lock handle is placed at locking position, the bulldozing blade, boom, and auxiliary hydraulic controls can't be locked.
Do not touch such controls accidentally.
- While lifting up or lowering down the safety lock handle, take cautions not to touch any joystick.
- Before leaving the driver seat, lower the working device onto the ground, lift up the safety lock handle to locking position, and stop the engine. Meanwhile, ensure to withdraw the key, close the doors and hoods, and carry the key with you and then preserve it in a designated place.

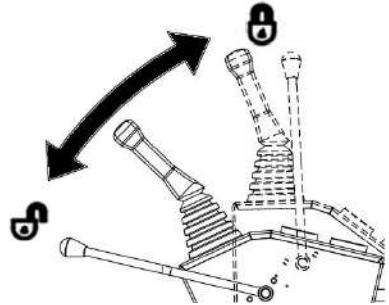

This device is functioned to lock the operations of bucket working device and machine slewing. When pushing the lever forward, except for the walking lever, the other levers cannot work

Accelerator joystick

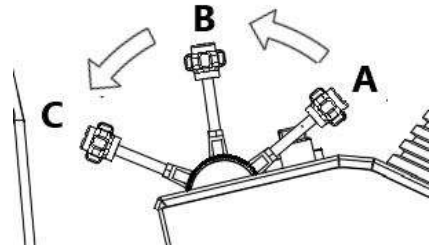

Used to control engine speed.

(A)...low idle

(B)...Maximum speed

Joysticks



Warning

- Before starting operations, please carefully check and confirm the joystick mode to be used.



Control Joysticks

- The descriptions in this manual use the ISO mode of machine.

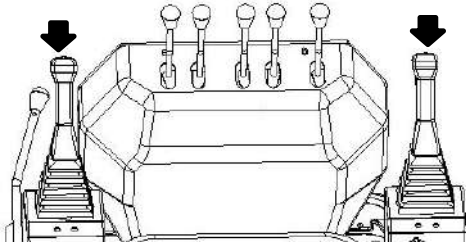

Control Mode

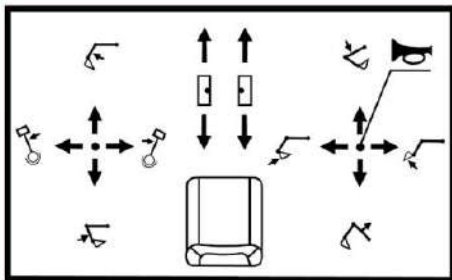

Bulldozing blade joystick

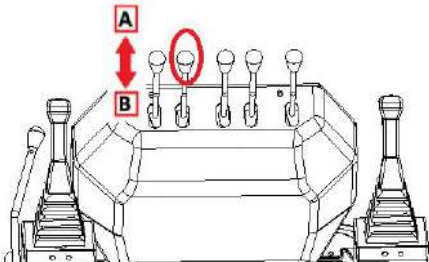

Use this joystick to operate the bulldozing blade.

- (A) ... Lower the bulldozing blade.
- (B) ... Lift the bulldozing blade.

Traveling Joystick



Warning

- Before operating the traveling joystick, ensure that the bulldozing blade is in front of the driver seat. Please bear in mind that the operation direction of the traveling joystick with bulldozing blade behind the driver seat is reverse to that with bulldozing blade in front of driver seat.

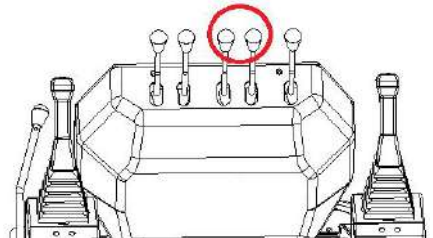

Use these two levers to move forward or backward and change direction.



Control Joysticks

Boom swing lever

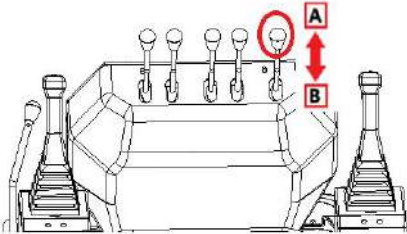

This lever controls the hydraulic oil flow and direction in the auxiliary hydraulic circuit.

- (A)Boom swing right
- (B)Boom swing left

Auxiliary hydraulic circuit control button

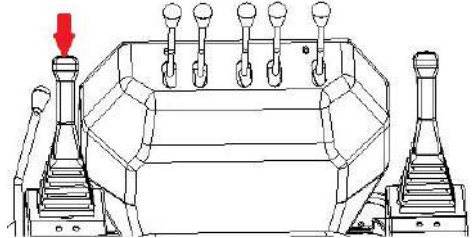

This button is used for the operation of attachments that require hydraulic power such as breakers.

1. First of all, make sure that you have correctly installed hydraulic attachments such as breakers.
2. Keep pressing this button to control the hydraulic attachments, and automatically return to normal control after releasing it.



Auxiliary hydraulic pipeline (If installed)

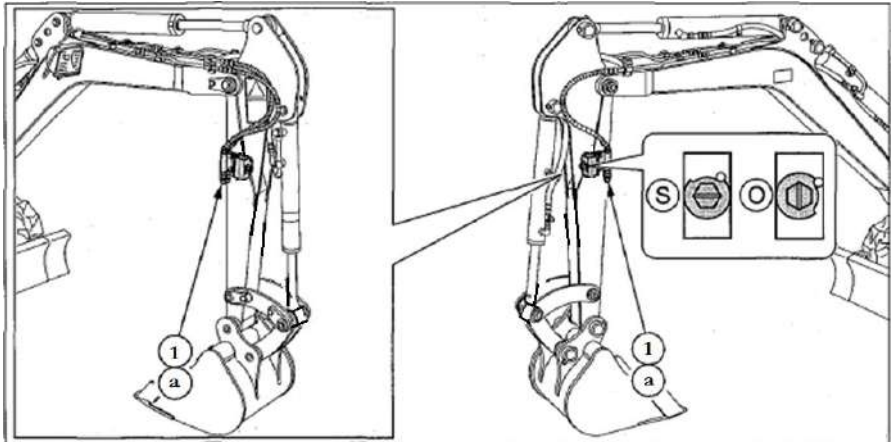

Warning

Disconnecting the pipelines before the pressure relief of hydraulic system will probably result in out-spray of hydraulic oil.

- **After the stop of engine, immediately press auxiliary switch for several times to relieve the pressure in the auxiliary hydraulic circuit.**
- **Slowly loosen the bleeding plug to relieve the internal pressure of hydraulic oil tank.**
- **While disconnecting hoses, stand on one side and loosen slowly. Slowly relieve the internal pressure before disassembling.**

These pipelines transport the hydraulic oil needed to operate hydraulic breakers or other working devices.

(1)... Auxiliary hydraulic pipeline

Shut-off valve

(S): Close

(O): open



Control Accessory

Connection of Hydraulic Circuits

To connect the attachment hydraulic pipeline, please operate as per following procedure:

1. Relieve the residual pressure from system and then close the shutoff valve.
2. Take out the plug.
3. Connect the attachment hydraulic pipes to ports (a). While installing a hydraulic breaking hammer, connect the oil inlet port to port (a) and oil return port to port (b).
4. Open the shutoff valve. While installing a hydraulic breaking hammer, open the selector valve (1).
5. After connections, fully bleed the air from hydraulic pipes.
 - a. Start the engine and run at low idling speed under no-load condition for 10min.
 - b. During the running of engine at low idling speed, operate the hydraulic auxiliary switch repeatedly (for approximately 10 times) to bleed the air from hydraulic pipes.
 - c. Stop the engine and wait for at least 5min, till the air bubbles overflow from the hydraulic oil in the oil tank.

Important: If applicable, follow the attachment manufacturer's procedure to bleed the air.

6. Check for presence of oil leakage.

Disconnection of Hydraulic Circuits

1. Relieve the residual pressure from system and then close the shutoff valve.
2. Disconnect the pipelines from ports.
3. Install the plug.

Relieve residual pressure

After using the auxiliary hydraulic circuit, there is residual pressure in the circuit. This is called residual pressure. Before disconnecting the pipeline, release the residual pressure.

Operations





Before Operations

Getting on/off Machine



Warning

- Do not jump on or off the machine. Do not attempt to get on or off a moving machine.

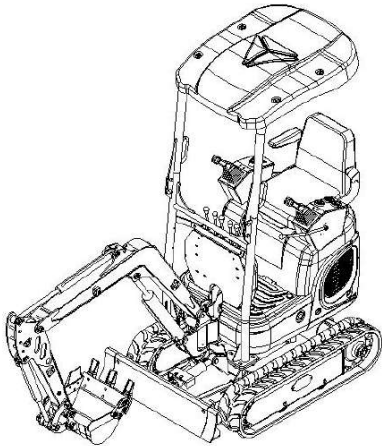

- While getting on/off the machine, hold the handrails to support your body weight and maintain three-point balance posture (Hands and feet) for your body.
 - Do not use safety lock handle or any joystick as handrail.
-

Walk-Around Checking

Before the first start of engine each day, fulfill one walk-around checking.

Refer to page 5-14 and 5-15 “Maintenance, Walk-Around Checking”.

Daily Routine Checking

Before the first start of engine each day, fulfill one walk-around checking.

Refer to page from 5-17 to 5-21 “Maintenance, daily routine inspection”.



Start and Stop of Engine

Before Start of Engine

1. Adjust the seat to comfortable operating position.

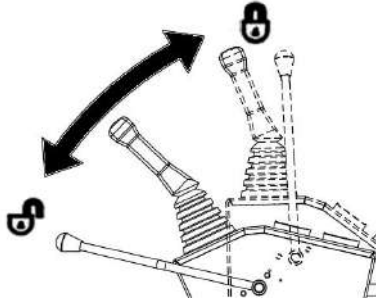

2. Check and ensure that the safety lock handle is at locking position.
3. Check and ensure that all joysticks are in neutral position.

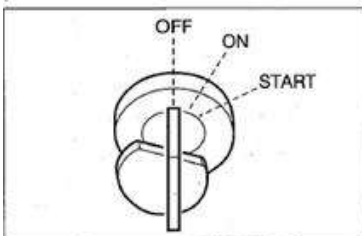

4. Insert the key into start switch, rotate to ON position, and then check as below:

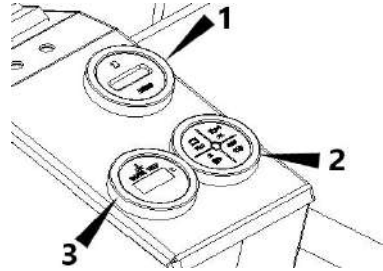

- All warning lamps turn on for 1s and the warning tone is issued for 2s. The instruments start working.
- Press the lamp switch and check and ensure that the boom lamp turn on.

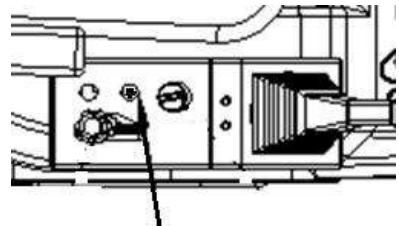

If a lamp fail to turn on or a warning lamp fails to sound, the lamp bulb or wire is probably damaged. Please contact Kenstone service agent for repair.



Start of Engine

 **Warning**

- Keep all personnel away from working zone.
- Sound the horn to alert the personnel around machine.

Important: Do not run the starter motor continuously for >15s. If the engine fails to start, wait for 60s and then attempt to restart the engine.

Important: If the engine stops due to shortage of fuel, please add fuel, rotate the key to ON for 60s, and then rotate it to START position. Running the starter motor for a long time before the supply of sufficient fuel will cause start failure of starter motor.

Normal Start

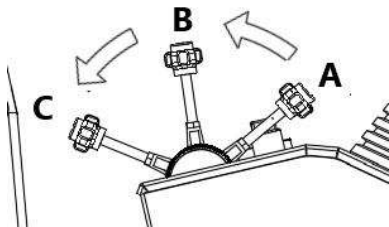

1. Pull the accelerator joystick to neutral position(B).

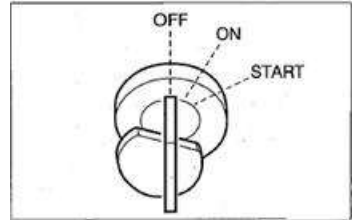

2. Rotate the starter key to START position to start the engine.
3. After the engine is started, release the key. The key will automatically return to ON position.
4. Check and ensure that all warning lamps are already off.
5. Return the accelerator joystick

Start in Cold Weathers

 **Warning**

Never use starting fluid on this engine, as the starting fluid will probably explode.

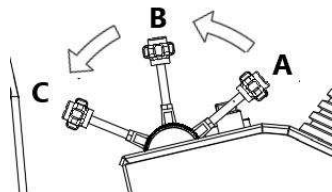

1. Pull the accelerator joystick to neutral position(B).

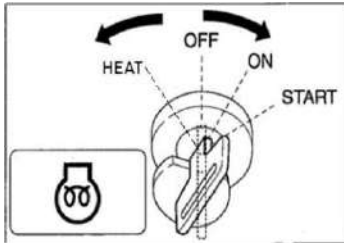

2. Rotate the start key counter-clockwise to HEAT position for approximately 10s. The preheated indicator lamp turns on to indicate the running of preheated.
3. Rotate the key to ON position, wait for the instrument lamp to turn off and the buzzer to stop sounding, and then rotate the key to START.
4. After the engine is started, release the key. The key will automatically return to ON position.
5. Check and ensure that all warning lamps are already off.
6. Return the accelerator joystick and warm up the engine. Refer to "Warm up the engine " item

Warm up the engine

Important: Before the completion of warm-up. Avoid the full-speed running of engine. Do not warm up the engine for a long time (20min or longer). When the idling is required, occasionally apply the load or run the engine at medium speed.

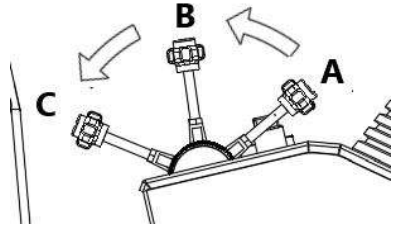

Return the accelerator joystick and then run the engine at low idling speed under no-load condition for 5min.



Stop of Engine

Important: Do not stop the engine suddenly under heavy load or during high-speed running. Otherwise it will result probably in overheating or blockage of engine. Do not stop the engine hastily, unless in event of emergency

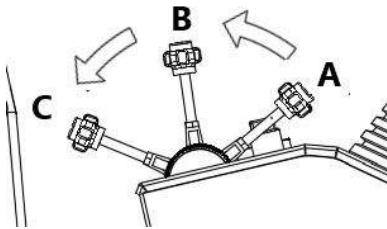

1. Return to the throttle lever.
2. Let the engine idle for about 5 minutes.
3. Turn the starter key to the OFF position to turn off the engine.

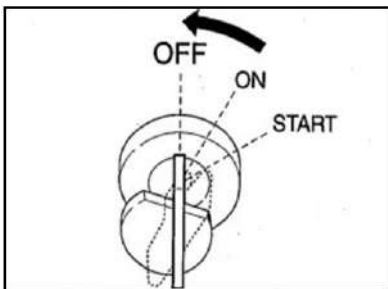



Operations Operate Machine

Operatie Machine

Joystick Mode (ISO Mode)



Warning

- Before starting operations, please carefully check and confirm the joystick mode to be used.
- The descriptions in this manual use the ISO mode of machine.

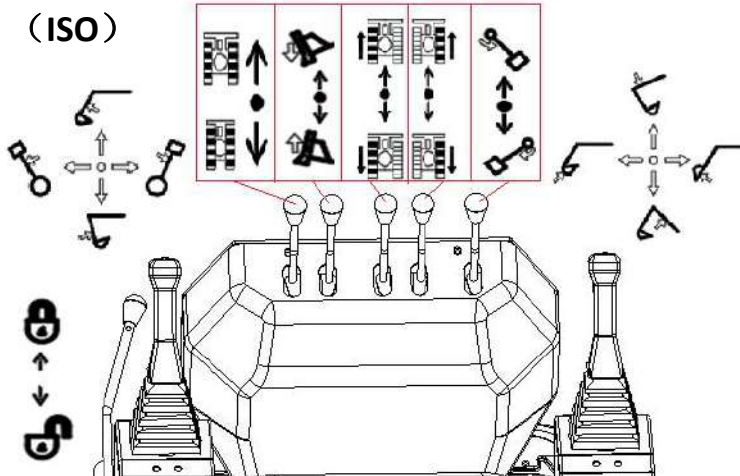

	Drive leftward		Drive rightward		Safety lock locked
	Back up to left		Back up to right		Safety lock unlocked
	Extend arm		Lower boom		Swing leftward the boom
	Retract arm		Lift boom		Swing rightward the boom
	Slew leftward upper frame		Load bucket		Lift bulldozing blade
	Slew rightward upper frame		Dump bucket		Lower bulldozing blade



Operations Operate Machine

Warm up the engine (hydraulic oil)

Warning



It's really dangerous to operate the working device without warm-up (Hydraulic oil), as the working device can't respond quickly to the controls or will motion probably in unexpected manner and the safety devices can't work normally probably. Therefore, ensure to warm up the machine sufficiently.

Important: When the hydraulic oil temperature is $<20^{\circ}\text{C}$, do not operate any joystick quickly. During the operations, the appropriate hydraulic oil temperature is $50\sim 80^{\circ}\text{C}$. If it's necessary to operate under low temperature, warm up the hydraulic oil to at least 20°C .

Normal Warm-up

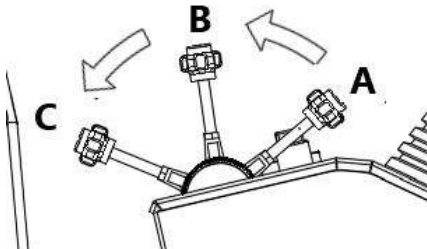

1. Pull the accelerator joystick to neutral position. Then, run the engine at medium

speed under no-load condition for approximately 5min.

2. Completely lower down the safety lock handle to unlock and lift the bucket from the ground.

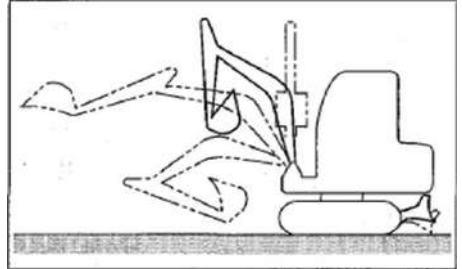

3. Slowly telescope all cylinders for several times under no-load condition.

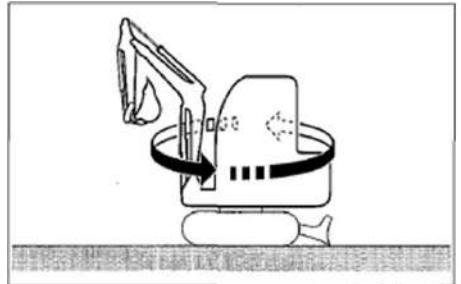

4. Slew slowly leftward and rightward for several times.



Operations Operate Machine

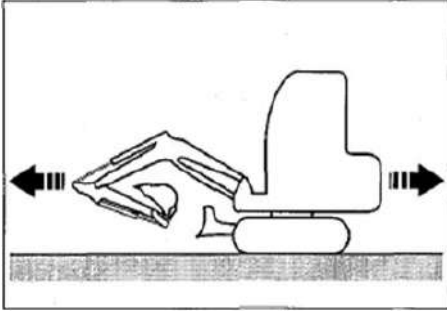

5. Drive forward and backward slowly for several times.

Warm-up in Cold Weathers

1. Fulfill the normal warm-up procedure.

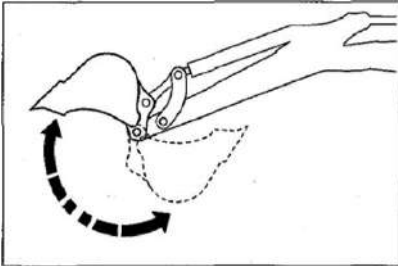

2. Operate the bucket cylinder to an end and hold.
Do not hold at this position more than 30s.
3. Repeat step 2, till the running speed of the bucket is normal.

Checking after Warm-up

After the warm-up of engine and machine (Hydraulic oil), check as per following procedure and when necessary repair.

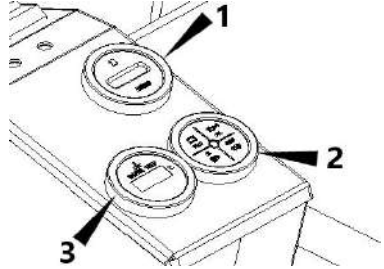

1. Check the warning lamps and instruments as below:
 - Whether all warning lamps turn off.
 - Whether the water temperature meter is $\leq 105^{\circ}\text{C}$.
2. Check for normal engine exhaust gas color, sound, and vibration.

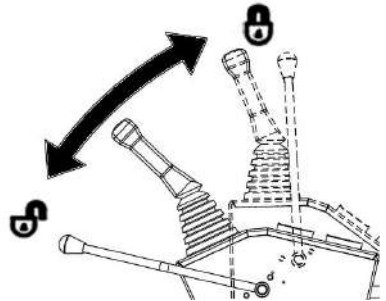

3. Lift up the safety lock handle to locking position and check whether the operation and traveling joysticks are locked.



Change of Chassis Width



Warning

Operating Machine with Maximum Width

- Always operate the machine with extended chassis width of 950mm, in order to improve the machine stability to the maximum extent. Operating the machine with narrow chassis width (800mm) will probably result in rollover of machine due to poor stability.
- If it's necessary to operate the machine with narrow chassis width (800mm), retract the bucket working device and lower the boom to reduce the gravity center and face the machine towards front before traveling.

This machine can change the track width.

Normally, to keep stable of machine, it's better to operate with extended track width.

Change of chassis Width

Operate in a level and solid ground without obstacles.

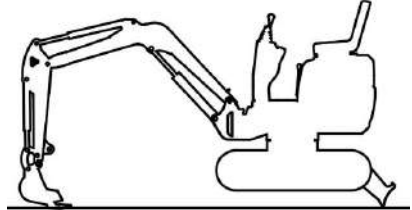

1. Lift the machine body by bucket working device and bulldozing blade.

Important: Ensure to lift the machine body before the change of track width. Attempting the operation with tracks on ground will probably damage the side traveling frame or span cylinder.

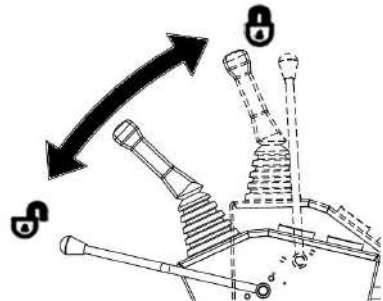

2. Unlock the safety lever.



Operations Operate Machine

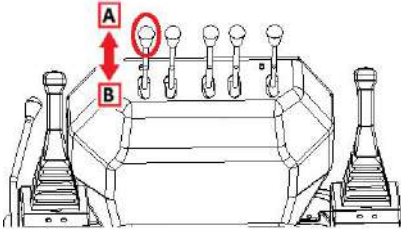

3. Push the lever forward to increase the width of the chassis to 950 mm.
4. Pull the lever backward to reduce the width of the chassis to 800 mm.

Change of bulldozer blade width

1. loosen the bolts(1) and take out the pins(2)

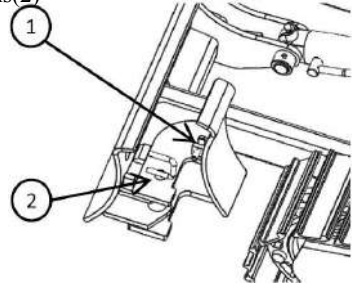

2. Rotate the extension plate around the pins for 180°.

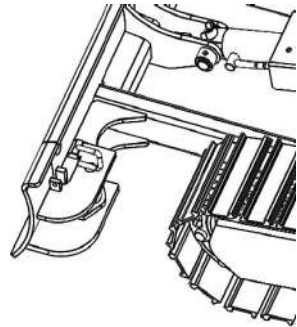

3. Install the pins and tighten the bolts.

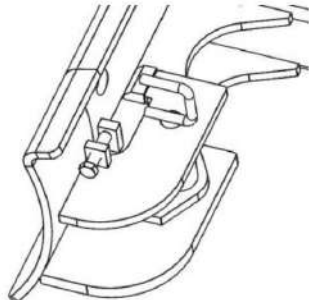



Operations Operate Machine

Operations of Traveling Joystick

Warning

- Do not allow any person to access the turning radius or path of machine.
- There are blind zones behind the machine. To reverse the machine, if necessary, slew the cab to check the safety and ensure there is no person behind the machine.

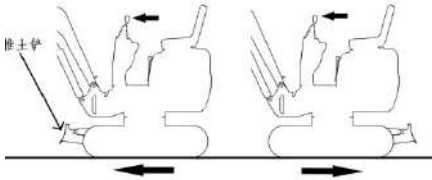

- Before operating the traveling joystick, ensure that the bulldozing blade is in front of the driver seat. Please bear in mind that the operation direction of the traveling joystick with bulldozing blade behind the driver seat is reverse to that with bulldozing blade in front of driver seat.
- Remove all obstacles from the path of machine.

Move the machine back and forth

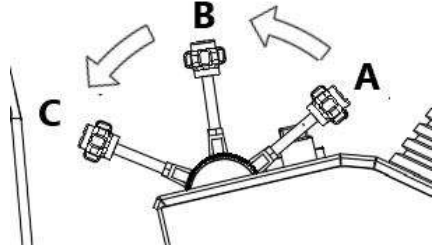

1. Pull the accelerator joystick to increase the engine speed.

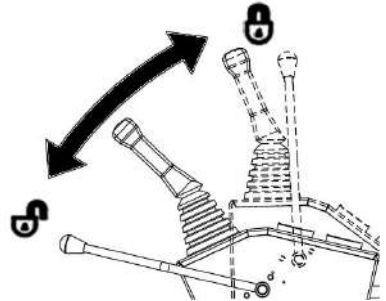

1. Fully lower the safety lock lever to release the lock.

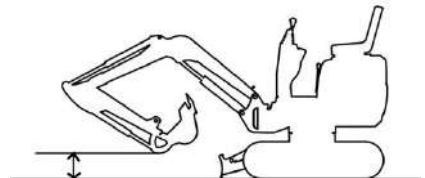

30-40cm (12 to 16 in)
(de 12 a 16 pulg)



Operations Operate Machine

3. Retract the bucket and lower to 30~40cm off the ground.
4. Lift the bulldozing blade.
5. Operate the traveling joystick as per following procedure.

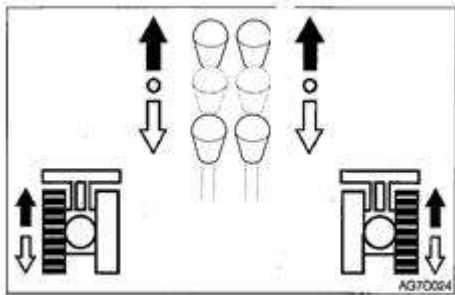

When the bulldozing blade is in the front of seat:

To drive forward: Pull forward the joystick.

To drive backward: Pull backward the joystick.

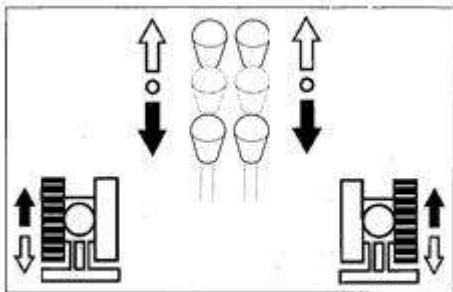

When the bulldozing blade is behind of seat:

To drive forward: Pull backward the joystick.

To drive backward: Pull forward the joystick.

Pivot Steering

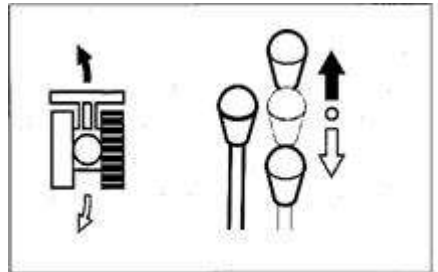

Turn left when parking:

to turn forward left: push the right traveling lever;

to turn back left: pull the right traveling lever.

Turn right when parking, same operating to operate the left traveling lever.



Operations Operate Machine

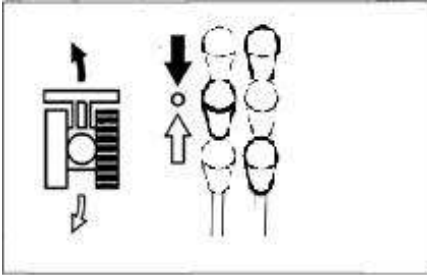

Turn left during traveling:

To turn left during traveling forward:

Place the left joystick to neutral position.

To turn left when traveling backward:

Place the left joystick to neutral position.

To turn right during traveling, operate the right traveling lever by same operation method of left traveling lever.

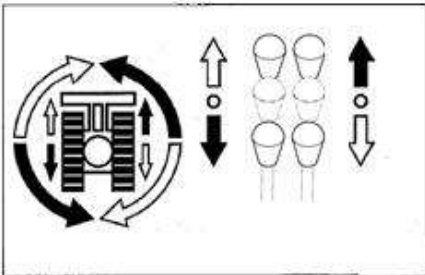

Rotate in situ

Rotate left in situ: pull left traveling lever backward and push the right traveling lever forward.

Rotate right in situ: pull right traveling lever backward and push the left traveling lever forward.

Parking



Warning

- Park the machine on a level, solid, and safe ground. Set the parking device. If it's necessary to park the machine on a slope, block the track by wedges to prevent movement of machine.
- When the safety lock handle is unlocked, the accidental touch of any joystick will result in sudden movement of machine and cause serious injuries or deaths.
- Please be noted that, even if the safety lock handle is placed at locking position, the bulldozing blade, boom, and auxiliary hydraulic controls can't be locked.

Do not touch such controls accidentally



Caution

Do not stop the machine hastily, unless in event of emergency. Stop the machine at the optimal timing whenever possible.



Operations

Operate Machine

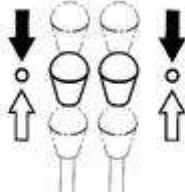

Slowly place the left and right traveling levers to neutral position. Stop the machine.

Operations of Working Device



Warning

- Before starting operations, please carefully check and confirm the joystick mode to be used.
- The descriptions in this manual use the ISO mode of machine.

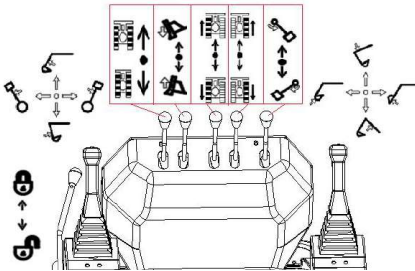

Use the right joystick to control the boom and bucket.

Use the left joystick to operate the arm and slewing.

Return the joysticks to neutral position to stop the bucket working device.

Lower down the safety lock handle to the unlocking position.

Slewing



Warning

Before slewing, check the surrounding area for safety.

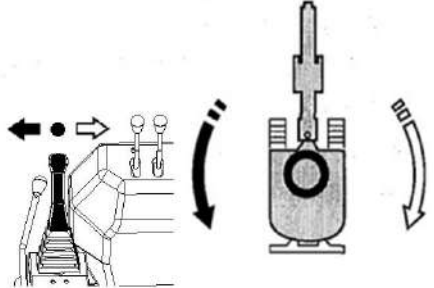

Slew the up-frame left: Push the left joystick left.

Slew the up-frame right: Push the left joystick right.

Operate the boom

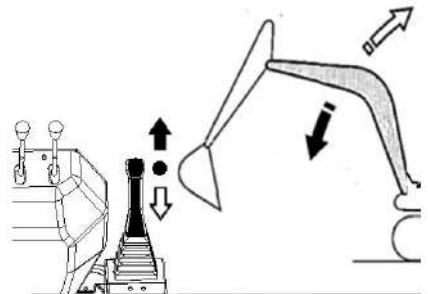

Lower boom: Push the right joystick forward .

Raise the boom: Push the right joystick backward .



Operations Operate Machine

Operations of Arm

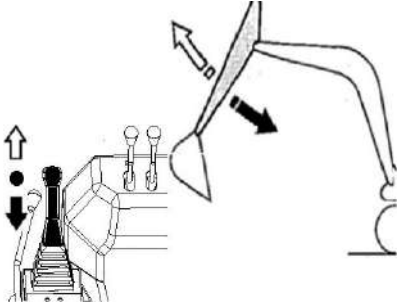

Retract bucket arm: Push the left joystick backward.

Extend bucket arm: Push the left joystick forward.

Swing of Boom

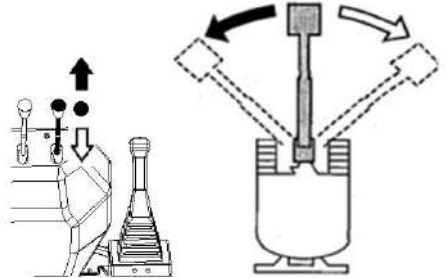

Swing the boom left: push this lever forward.

Swing the boom right: pull this lever backward.

Operations of Bucket

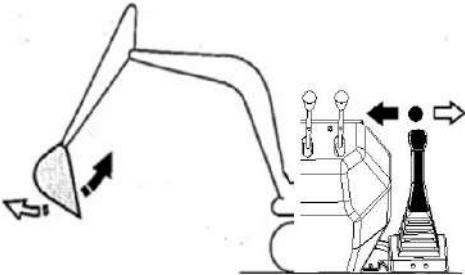

Load bucket: Push the right joystick left.

Dump bucket: Push the right joystick right.

Operations of Bulldozing Blade

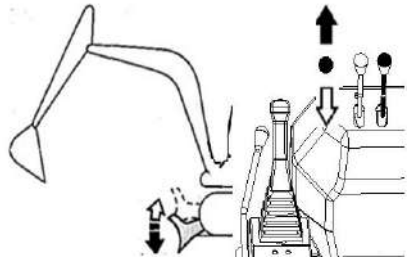

Lower bulldozing blade: Push this lever forward.

Raise bulldozing blade: Pull this lever backward.



Operations Operations Procedures

Operations Procedures

Prohibited Operations



Warning

- Do not operate on a bed rock (hard or soft).
- Do not slew during the traveling. If it's necessary to operate the bucket working device during traveling, operate at sufficiently low speed to ensure the complete control at all times.

Do not use the slewing force for demolition or leveling operations.

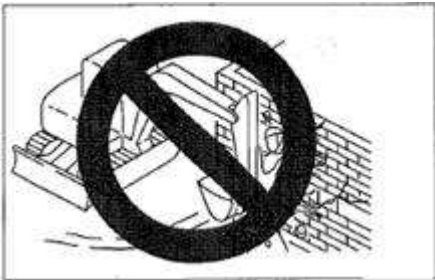

Do not use slewing force to dismantle walls or level ground. In addition, do not insert the bucket teeth into the ground during slewing. Otherwise the bucket working device will be damaged.

No Digging during Traveling

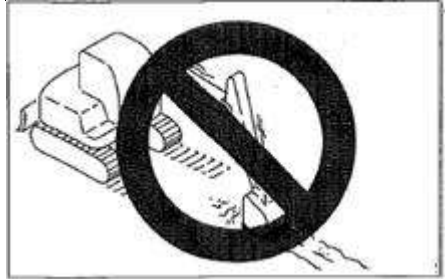

Do not insert the bucket into the ground or use the traveling force for digging.

Steady Operations of Hydraulic Cylinders

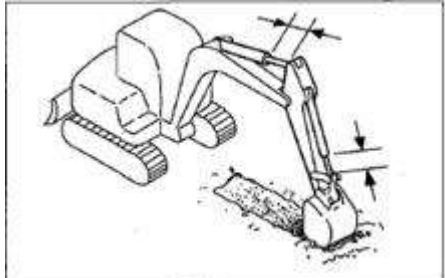

Do not extend any hydraulic cylinder to the end. Reserve an allowance during operations.

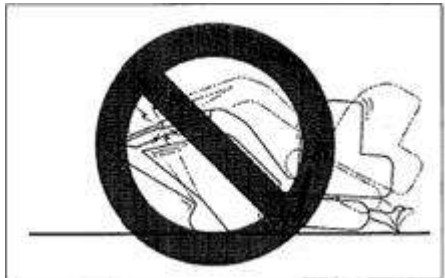



When the machine body is lowered and the bucket arm cylinder is completely extended, do not support the machine body by bucket working device. Otherwise, the load will be concentrated on the bucket arm cylinder to probably damage the bucket arm cylinder.

No Digging by Pulling or Hammering Bucket



This will shorten the life of bucket working device. Dig by hydraulic force.

Do not operate by the down force of machine.



Using additional tension onto the machine will shorten the life of machine. During digging, use the hydraulic force of cylinders by shallow depth and large travel.

Digging of Bed Rock

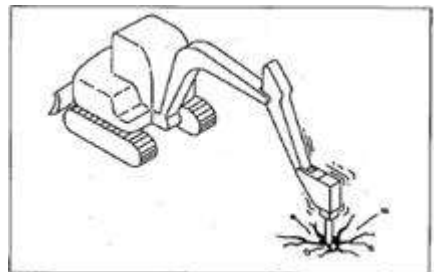

For hard bed rocks, it's preferable to break the



rock into small pieces by breaking hammer before digging. It can prevent the damages of machine and thus can be more economic.

Guard Bulldozing Blade against Impact



Impacting the bulldozing blade with rock will damage the bulldozing blade and bulldozing blade cylinder.

Careful Retraction of Bucket Working Device



While retracting the bucket working device, take cautions not to impact the bucket with bulldozing blade.

Prohibited Use of Bulldozing Blade as Support



Caution of Bulldozing Blade during Digging



For deep digging operations, if the bulldozing blade is in the front, take cautions to prevent impacting the boom and bucket with bulldozing blade.

During operations, place the bulldozing blade on the rear of machine whenever possible.



Operations Operations Procedures

Caution of Downward Digging with Bulldozing Blade

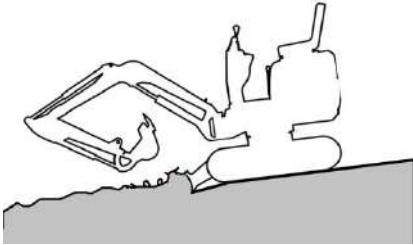

This bulldozing blade is designed for simple bulldozing operations. Do not use the bulldozing blade for deep digging. Otherwise, the bulldozing blade and the under frame will probably be damaged.

Precautions for Operations Precautions during Traveling

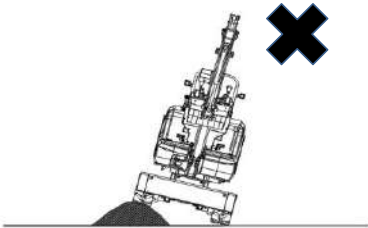

Driving the machine over obstacles (Including rocks and stumps) will probably apply high load onto the machine body and damage the machine. Avoid driving over obstacles

whenever possible. If it's necessary to drive over obstacles, close the bucket working device to the ground, drive the machine at low speed, and drive the machine in such manner that the obstacles are in the middle of tracks.

Precautions for Operations of This Machine in Water



It's prohibited to immerse the rear of machine in the water.

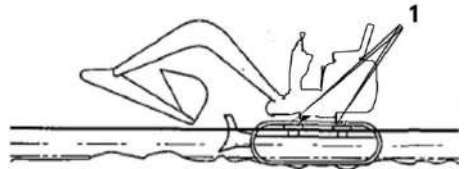



- Permissible water depth
Operate this machine in the water only when the water level is not above the middle of track shoe (1).
- For those parts used in water for a long time, add sufficient grease till the used grease is squeezed out.
- Do not immerse the slewing support or body in the water or sand. If already immersed, please contact a Ken stone service dealer for checking.

Precautions for Traveling on Slopes



Warning

- **Do not drive the machine on a slope steep enough to cause instability of machine. Please be noted that, in the actual applications, the performances of machine on a slope will be deteriorated due to severe working conditions.**
- **While traveling on a slope, lower the bucket to 20~30cm off the ground. While climbing up a steep slope, extend the bucket working device to the front position. In event of an emergency, lower the bucket onto the ground and stop the engine of machine.**
- **While traveling on a slope, drive slowly in 1st gear (Low speed).**
- **Keep the driver seat facing towards the up slope direction while climbing up a slope. Keep the driver seat facing towards the down slope direction during down slope traveling. In both cases, pay special attention to the ground ahead of the machine during traveling.**
- **Do not reverse the machine down a slope.**



Operations Operations Procedures

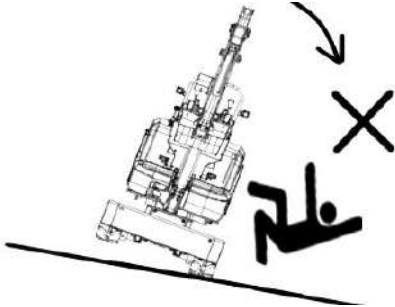

- Do not change direction on a slope or lateral slope. Firstly return the machine to a level ground and then select another path.
- The machine will probably slip laterally while traveling on a gentle slope covered by grass or dry leaves or traveling on a wet metal plate or frozen surface. Do not park the machine laterally on a slope.

Traveling Posture on Slopes

Up slope Traveling

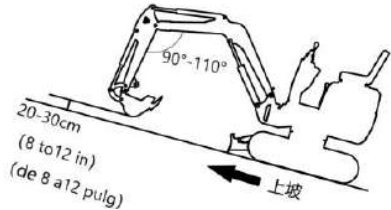

To climb up a 15° or higher slope, maintain the machine posture as shown in above diagram.

Downs lope Traveling

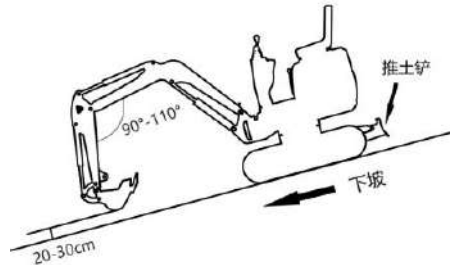

While driving down a 15° or higher slope, reduce the engine speed and maintain the machine posture shown in above diagram.



Braking during Downs lope Traveling

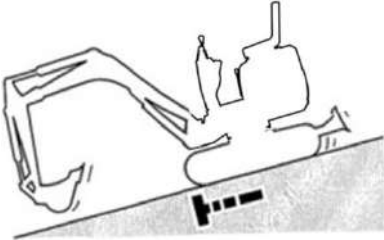

While driving down a slope, the brake applies braking automatically after the traveling joystick returns to neutral position.

In Event of Engine Flame out

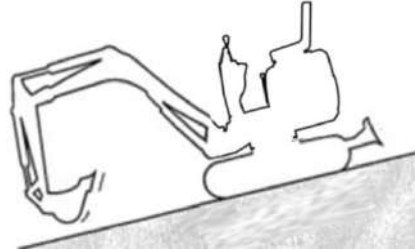

If the engine stops while driving down a slope, shift the traveling joystick to neutral position, stop the machine, and then restart the engine.

In Event of Track Slip

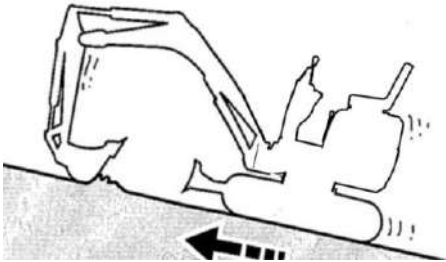

In event of traveling failure due to track slip while climbing up a slope, use the digging force of bucket arm to climb up the slope.



Operations Operations Procedures

Out of the mud

If the machine is entrapped in the mud, drive out as per following procedure.

If a track gets stuck in the mud



1. Swing the bucket towards the track entrapped in the mud.
2. Set the angles at $90\sim 110^\circ$ for bucket arm and boom.
3. Push the bucket bottom (Not bucket teeth) onto the ground.
4. Place a wood plate or similar object beneath the lifted track.
5. Lift the bucket and drive out the machine from the mud slowly.

If both tracks are stuck in the mud

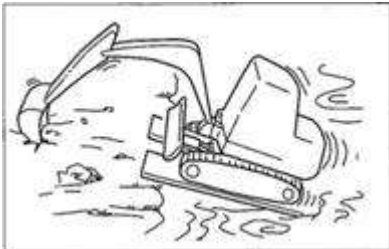

1. Operate above-mentioned steps 1~4 for both tracks.
2. Insert the bucket into the ground in the front of machine.
3. Pull the bucket joystick during forward traveling to slowly drive out the machine.

Allowed Operations of Machine Digging

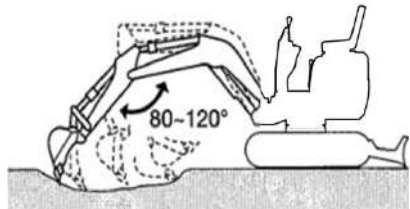

1. Place the bulldozing blade to the opposite side of the digging zone.
2. Dig by bucket arm and bucket. It's preferable to dig by shallow depth and large travel. The maximum digging force is achieved when the angle between boom and bucket arm is $80\sim 120^\circ$. It's preferable to change the angle for effective digging.



Operations Operations Procedures

Ditching

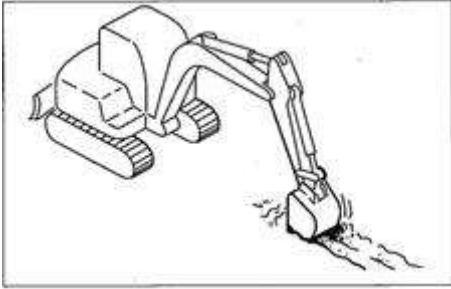

Install a bucket suitable for digging of ditches, adjust the tracks to be parallel with the ditch to be dug, in order to improve the working efficiency. While digging a wide ditch, dig the side faces and then the middle area.

Digging of Side Drainage Ditch

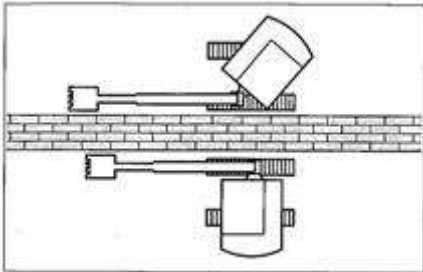

As shown in the diagram, dig the side ditch by swing function of boom.

Loading

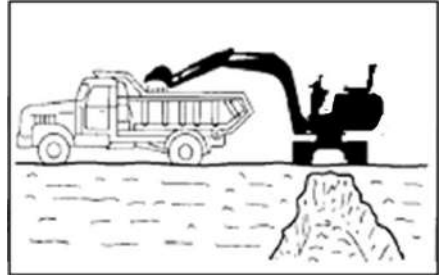

While loading soil into the cargo body of a truck, loading from the rear end of truck can load more soil easier than loading from the front end. In addition, the small angle slewing can be used to improve the efficiency.

Leveling

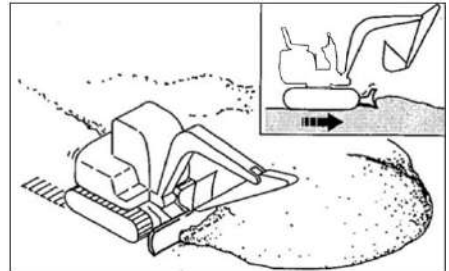

1. Close the bucket working device to the machine body.
2. Slowly push away the soil from the side face of soil pile.
3. If the soil pile is low, push the soil from the top. If the load is too heavy for the machine body, lift or lower the bulldozing blade for adjustment.



Parking of This Machine

Parking



Warning

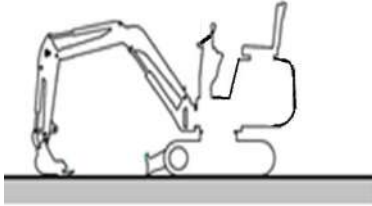

- **Stop the machine on a level, solid, and safe ground. Set the parking device.**

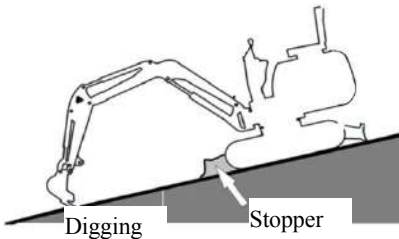

- **If it's necessary to park the machine or tilt the machine on a slope, securely park the machine and block the machine against movement.**
- **While parking the machine in a street, use gratings, warning signs, or lamps to keep the visible even in the night, in order to prevent the impact with other**

vehicles.

- **Before leaving the seat, lift up the safety lock handle to the locking position and stop the engine. Meanwhile, ensure to withdraw the key, close the doors and hoods, and carry the key with you and then preserve it in a designated place.**
1. Place the left and right traveling joysticks to neutral positions.
 2. Push backward the accelerator joystick to idle the engine.
 3. Lower the bucket and bulldozing blade onto the ground.
 4. Lift up the safety lock handle to the locking position.

For details, please refer to "Stopping the Engine" on page 3-6.

Checking after Stop of Engine

1. Check for leakage of oil and water and check the working device, cover, and under frame. Upon detection of any abnormality, repair.
2. Fully fill fuel.
Refer to page 5-21 "Checking of fuel level".
3. Remove paper fragments and dusts from engine compartment.
4. Remove the mud from under frame.



Parking of This Machine

Locking

Ensure to lock the following parts.

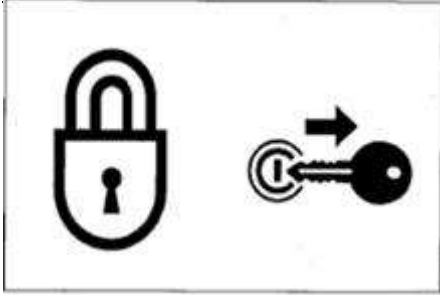



Treatment in Cold Weathers

Preparations for Cold Weathers

It's difficult to start the engine in cold weathers.

Replacement of Fuel and Lubricants

Replace the hydraulic oil, engine oil, and fuel with trademarks suitable to cold weathers.

Refer to page 5-4 "Fuel and Lubricant Table".

Battery

The battery performance deteriorates along with the reduction of temperature.

Check the battery. Upon detection of battery discharging, please contact a Ken stone service provider for charging.

Refer to page 5-28 Checking of battery electrolyte level and adding of electrolyte".

Precautions after Operation

Please abide by the following precautions to prevent the movement failure of machine due to frozen mud, water, or under frame.

- Remove all mud and water from machine body. Especially, wipe clean the hydraulic cylinder rod to prevent the ingress of rod surface mud and dusts into the seals along with water drops from damaging the seals.
- Park the machine on a solid and dry ground. If impossible, park the machine on a ground paved with wood boards.

- Fully drain the water from fuel tank to prevent freezing.
Refer to page 5-27 "Water drainage from fuel tank".
- As the battery capacity will drop remarkably in low temperature environment, cover the battery or take the battery out of the machine and store it in a warm place. If the electrolyte level is too low, add distilled water before starting operations in the morning. To prevent the freezing of battery electrolyte at nighttime, do not add water after the daytime operations.

After Cold Weathers

When the weather becomes warm, fulfill the following operations.

- Replace the fuel and lubricating oil for all parts as per the trademarks specified by "Fuel and Lubricant Table".
Refer to page 5-4 "Fuel and Lubricant Table".



Handling of Rubber Tracks

This machine is equipped with rubber tracks and the rubber tracks have their intrinsic weakness, namely low strength. Please ensure to abide by the following prohibitions and precautions to prevent damage and falloff of rubber tracks.

Prohibition

Do not drive or operate the machine in following sites:



- Driving and steering the machine on gravels, rough and hard rocks, steel beams, or scrap irons or near the edges of steel plates will damage the rubber tracks.



- Driving the machine on a riverbed or place with numerous pebbles can probably result in inclusion of pebbles in the tracks and the damage or falloff of tracks.



- Do not operate this machine by the sea. The salt content will probably corrode the steel core.



- Keep the tracks away from the adhesion of fuel, lubricating oil, salt, and chemical solvent. These substances will probably corrode the welds of track steel cores to cause rusting or falloff. Such substances adhered onto the tracks shall be immediately removed by water.



- Driving the machine on irregular surfaces, such as new asphalt pavement and hot steel plates exposed to campfire or burning sun will result in irregular wear or damage of tracks.
- Do not move the rubber tracks to possibly slip ground. Otherwise, the wear of the tracks will be probably accelerated.

Precautions

Please abide by the following precautions during the operations of this machine:



- Do not slew the under frame (The superstructure is not slewed) when the bucket working device is lifted in the front of machine body. Otherwise, the load will be concentrated at single point of tracks and the tracks will be twisted to cause rapid damage.
- In all cases, avoid changing the route suddenly or avoid the in-situ steering on concrete surface whenever possible. Otherwise the rubber tracks will be worn or damaged.
- Avoid the strong impact onto the rubber tracks due to falloff.
- The tracks will be damaged by salt, potassium chloride, ammonium sulfate,



Operations Handling of Rubber Tracks

potassium sulfate, and lime triple super phosphate. Such substances adhered onto the tracks shall be immediately removed thoroughly by water.

- Keep both sides of rubber tracks away from friction with concrete or wall surface.
- Do not impact the bucket with the rubber tracks, otherwise the tracks will be damaged.
- Take special cautions on snowy or icy surfaces in winter, as the tracks are vulnerable to slip on such conditions.
- Please use rubber tracks within $-25^{\circ}\text{C}\sim 55^{\circ}\text{C}$.
- For long-time storage (≥ 3 months) of rubber tracks, please store in an indoor place without direct sun exposure or rainfall.



- The rubber tracks are not as stable as steel tracks, as they are completely made of rubber. Take special cautions during the lateral slewing and swing.

Guard against Falloff of Rubber Tracks

Abide by the following precautions to prevent the falloff of tracks:

- Always maintain an appropriate tension for the tracks.

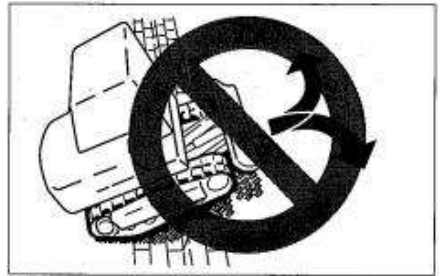

- When driving over pebbles or large steps ($\geq 20\text{cm}$ in depth, such as large rocks), climb on the steps in right angle and do not change route on steps.



- While reversing up a slope, do not change direction at the start point of slope.



Operations Handling of Rubber Tracks



- Please avoid driving the machine with one track on a slope or protrusion and the other track on level surface (In such case, this machine is inclined by 10° or more). Please drive the machine with both tracks on level surface.

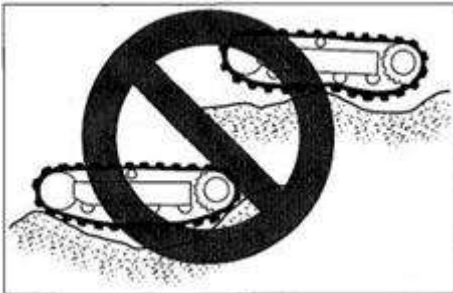

- Do not change the direction when the tracks are loose as shown in the diagram.

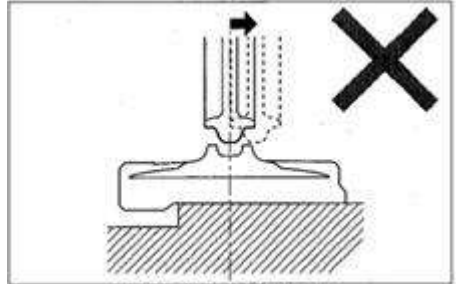

- In such case, the rubber tracks will fall off if the machine drives backward.

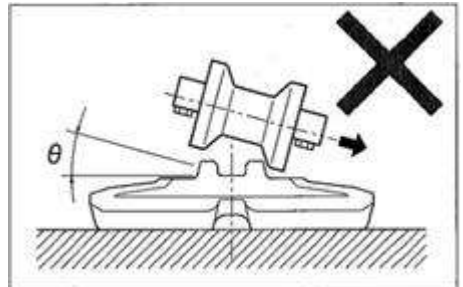

- In such case, the rubber tracks will fall off if the machine slews.

Transportation





Loading and Unloading

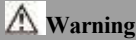

Warning

The machine will probably roll over or fall off during unloading. Ensure to take the following safety measures:

- Select a solid and level ground and keep a sufficient spacing from the road curb.
- Fix the ramps of sufficient strength and dimensions to the cargo body of truck. The inclination of the ramps shall not exceed 15°. If the ramps deflect downward excessively, please support the ramps by supports or cushion blocks.
- Do not load or unload the machine by working device. Otherwise, it will probably result in rollover or falloff of machine.
- Keep the truck cargo body and the ramps clean without oil, sand, ice/snow, or other impurity, in order to prevent the side slip of machine. Clean the tracks.
- Block the wheels of transport truck by wedges to prevent movement.
- While loading or unloading the machine, drive the machine slowly in 1st gear (low speed) as per the signals of the signaler.
- Do not change direction on ramps.

- Do not slew/swing on ramps. Otherwise the machine will probably roll over.
- Slewing/swinging the machine on the cargo body of truck will probably result in unstable legs of machine. Therefore, operate slowly.
- If possible, lock the cab doors after loading. Otherwise the cab doors will probably open during the transport.
- Plug securely the tracks by wedges and then fix the machine to the truck cargo body securely by ropes or chains.

During the loading or unloading of machine, please ensure to use ramps or platform and abide by following procedures.

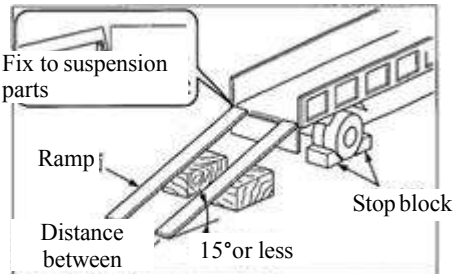

1. Securely apply the parking device of transport truck and block the wheels by wedges.
2. Place the ramps securely onto the truck cargo body. The inclination of the ramps shall not exceed 15°.



Transportation Loading and Unloading

3. Align the center of truck cargo body with the center of machine and align the center of ramps with center of tracks.
4. Ensure that the bulldozing blade will not touch the ramps.
5. Lower the bucket working device as low as possible and take cautions not to impact it with the transport truck.
6. Reduce engine speed.

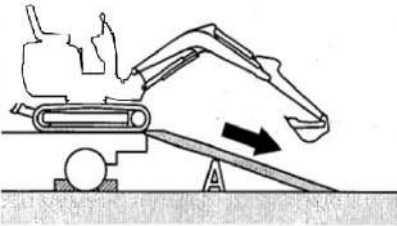
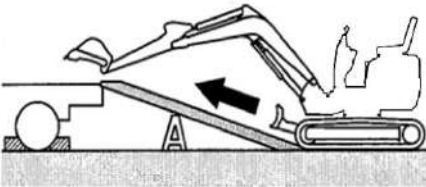

7. According to the signaler's signals, drive the machine straightly up or down along the ramps in 1st gear (low speed).
8. Load the machine to designated position of transport truck. Refer to "Transport Status" in page 4-6 for details.



Lifting of Machine



Warning

- **Master and use the correct lifting signals.**
- **Daily check the lifting device for damaged and missing parts and when necessary replace.**
- **Please use the ropes of sufficient capacity for the machine weight during lifting.**
- **Lift the machine as per the procedure described below. Do not operate by any other method. This is really dangerous as it will probably result in imbalance of machine.**
- **Do not operate the lifting if there is any operator on the machine.**
- **Operate slowly during lifting to prevent the rollover of machine.**
- **During lifting, keep all personnel away from working zone. Do not move the machine over any person.**

Important: This lifting method is applicable for the models with standard overall parameters. The gravity center varies depending on the installed attachments and optional devices. To understand more details, please contact your Ken stone service dealer.

Lifting

1. Slew the superstructure to place the bulldozing blade behind the machine (Adjust the superstructure to be parallel with track frame).
2. Lift the bulldozing blade to highest position.
3. Sufficiently extend the bucket cylinder and bucket arm cylinder and lift the boom to highest position.
4. If the boom swings leftward or rightward, adjust it to neutral position.
5. Raise the safety lock control lever to the locking position.
6. Stop the engine, withdraw the starter key, and leave the machine.
7. Install the ropes as shown in diagram below. Install the ropes and lifting appliance and take caution to keep them away from machine body.
8. Slowly lift the machine, till it's off the ground.
9. Stop the lifting till the machine becomes stable and then lift the machine again.



Transportation Lifting of Machine

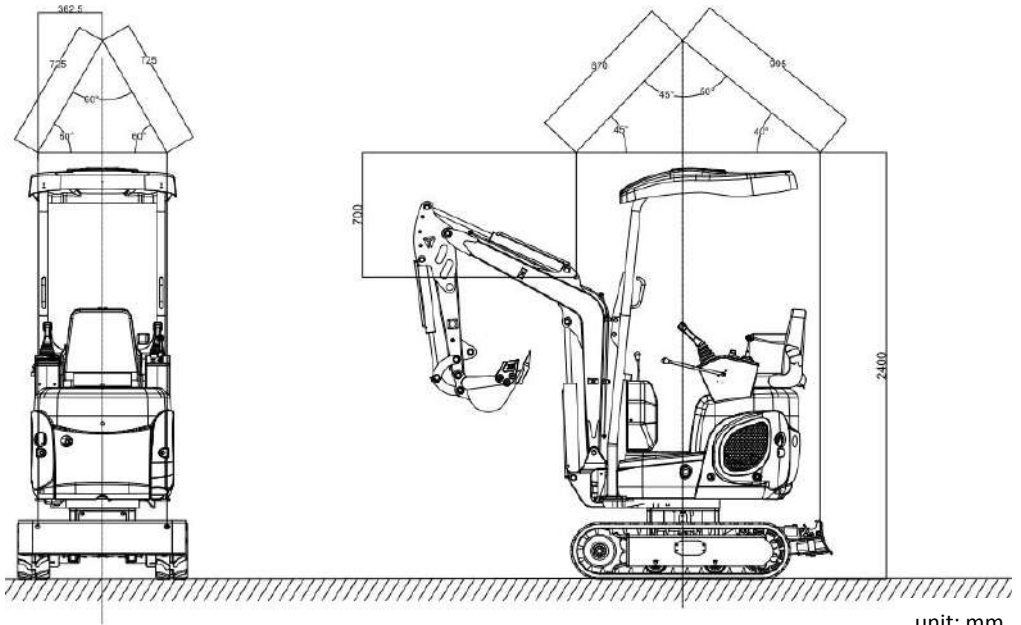



Fixing of Machine

After loading the machine to designated position, fix as per following requirements.

Transport Status

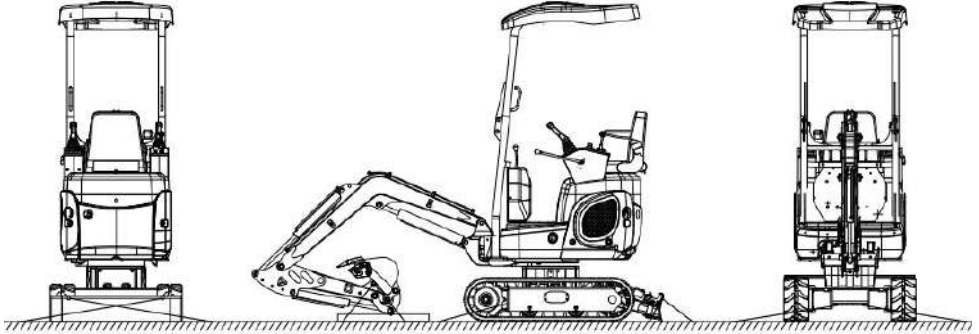

1. Lower the bulldozing blade.
2. Sufficiently extend the bucket cylinder and bucket arm cylinder and then lower the boom.
3. Lift up the safety lock handle to the locking position.
4. Stop the engine, withdraw the starter key, and lock all locks.
5. Place the stop blocks (Wedges) on the front and rear of tracks.
6. Affix chains or ropes securely to the lower framework of machine, in order to prevent the side slip of machine.
7. Fix the bucket by chains or ropes.

Important: A wood board can be placed beneath the bucket to prevent damaging the ground by the bucket.

Safety Measures Taken during Transport



Warning

- During the transport of machine, understand and abide by all applicable safety rules, vehicle codes, and traffic regulations.
- Take the length, width, height, and weight of the transport truck with loaded machine into consideration, in order to select the best transport route.
- During the transport, do not start up or stop the transport truck suddenly or drive at high speed. Otherwise, it will result in movement or unbalance of loaded machine.

Maintenance





Overview

Maintenance Overview

To maintain the good status and long-term serviceability of the machine, please fulfill the checking and maintenance correctly and safely abide by the procedures recommended by this manual.

Based on the total operating time of the machine, the checking and maintenance items can be divided into several groups: Every 10h (Walk-around checking and daily routine checking), every 50h, and every 250h. Please refer to the reading of hour meter to determine the checking and maintenance timing. The items for which the checking and maintenance intervals can't be determined are listed in column "As necessary".

When the machine is operated in extremely severe environment (Dusty or high temperature environment), fulfill the checking and maintenance ahead of the periods specified by maintenance schedule.

Maintenance Precautions

Do not fulfill any other checking or maintenance item not listed in this manual. For the items not listed in this manual, please ask your sales or service dealer for help.

Keeping Machine Clean

- Clean the machine before checking and

maintenance. Keep the machine clean.

- Stop the engine before cleaning the machine. Cover the electric parts against water ingress. The water ingress into the electric parts will probably result in short-circuit or malfunction. Do not clean the battery, electronic control units, sensors, connector, or operating room by water or steam.

Fuel, Lubricating Oils, and Greases

- Select fuel, lubricating oils, and greases as per the "Fuel and Lubricant Table".
- Use the water-free fuel, lubricating oil, and grease. Take cautions to eliminate the ingress of dusts during replacement or filling of fuel, lubricating oil, and grease.
- Store the fuel, lubricating oil, and grease in designated location and guard against the ingress of water and dusts.

Precautions for Refueling

- If the fuel filler port is installed with a filter screen, do not remove the filter screen during refueling.
- Please ensure to tighten the fuel tank cap after refueling.
- The refueled volume shall not exceed the designated fuel volume.

No Cleaning of Engine Parts by Fuel

It's prohibited to clean engine parts by fuel. Use



non-flammable detergent.

Guard against Ingress of Dusts

The installation and disassembling of parts shall be operated in a dust-free place. Clean the working area and clean the parts to guard against ingress of dusts.

Cleaning of Mounting Surfaces

Keep clean the contact surface of parts during the installation and disassembling. If the sealing grooves of the contact surfaces are damaged, please contact your sales or service dealer for repairs or breakup.

Seal Rings and Split Pins

- Ensure to replace all disassembled seal rings and split pins with new ones.
- Take cautions not to damage or twist any seal ring during installation.

Seal Rings

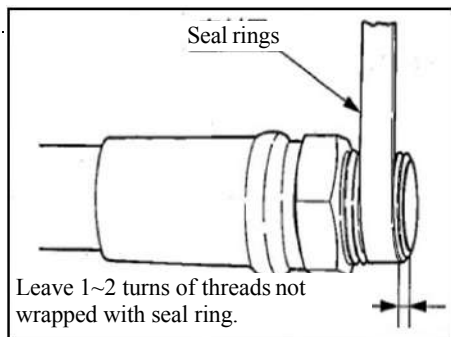

- While wrapping the screw plug with seal ring tape, thoroughly remove the used seal ring tap from the threads and clean the threads.

- Wrap the threads with seal ring and notice to leave 1~2 end threads of screw plug not wrapped with seal ring.

Waste Disposal

- Ensure to collect the drained oil of machine into a container. The improper treatment of waste oil will pollute the environment.
- While disposing harmful objects, including lubricating oil, fuel, coolant, filter, and battery, please abide by the applicable laws and regulations.

Checking after Maintenance

- Accelerate the engine speed gradually from idling speed to fastest speed and check for leakage of oil or water from repaired parts.
- Operate all joysticks and check machine for normal operations.

Precautions for Wire Connections of Battery

- Before operating the electronic system or performing electric welding, disconnect the wires from both electrodes (+ and -) of the battery.
- Ensure to disconnect it from the grounding electrode (-). Finally connect the grounding electrode during connection.
- Do not disconnect the battery wires during the normal running of engine. Otherwise, the rotary converter circuit or other parts will probably be damaged.



Service Data

Fuel and Lubricant Table

Please refer to following table to select appropriate fuel, lubricating oil, and grease based on the temperature.

- Regardless of the specified periods, replace the oil when the oil is too dirty or already deteriorated.
- Never mix the oils of different trademarks while adding fuel/oil. To replace with fuel/oil of other trademark, please replace completely.

Fuel

Specified fuel

The diesel shall meet the following specification. This table lists some diesel specifications available in the world.

Diesel specification	Region	Diesel specifications	Region
GB252	China	JIS K2204, grade 2	Japan
ASTMD975 No. 1-D, S15 No. 2-D, S15	USA Canada	ISO 8217DMX	Worldwide
Bio-diesel Bio-diesel mixture B5 ASTM D6751, D7467			
EN590 : 2009	EU	BS2869-A1 or A2	UK
Bio-diesel Bio-diesel mixture B5 EN14214, EN590			



Fuel tank	Diesel	<p>To maintain the performance and life of engine, please always use clean and high-quality fuel.</p> <ul style="list-style-type: none">● To prevent freezing in cold weathers, please choose diesel still suitable when the actual temperature is less by at least 12°C than the expected minimum outside temperature.● Please use diesel with cetacean number at 45 or higher. During the operations in low temperature or high altitude regions, use fuel of higher cetacean number.● Use fuel with sulfur content (volume ratio) at <0.5%. Use ultra-low sulfur fuel especially in U.S. and Canada. The use of fuel with high sulfur content can probably result in sulfur acid corrosion in engine cylinders.● Do not mix the diesel with kerosene, used engine oil, or residual fuel. It's prohibited to use kerosene.● The low quality fuel will reduce the engine performance and/or damage the engine.● It's not recommended to use fuel additives. Some fuel additives will deteriorate the engine performances. <hr/> <p>Safety measure for use of bio-diesel The warranty regulation of the engine manufacturer is void for the engine using disqualified or deteriorated bio-diesel.</p>
-----------	--------	---



Maintenance Service Data

Lubricant

Position	Type	Type depending on temperature							Replacement period
		-20	-10	0	10	20	30	40°C	
Oil sump	Diesel engine fuel API: grade CD ACEA:E-3,E-4 or E-5					SAE 10W-30			First 50h * Afterwards every 250h
						SAE 15W-40			
Hydraulic oil tank	Anti-wear hydraulic oil					ISO VG32			Every 2000h ***
						ISO VG46			
						ISO VG68			
Cooling system	Coolant (Water+ coolant) ** SAE: J814C or J1034					50% coolant mixture			Every 1000h
						30% coolant mixture			
Traveling reducer gear	Gearbox API: GL-4					SAE 90			First 250h * Afterwards every 1000h
Slewing motor gear	Lithium-base grease EP-2 MLGI 2#								Every 50h
Slewing bearing									Every 50h
Working device									Daily or every 10h
Arm									As necessary

*: If the traveling time accounts for a high ratio of the total operating time, replace the gear oil ahead of the specified periods.

** : Use running water (soft water). Do not use well water or river water. If the outside temperature is <0°C, add coolant (antifreeze). Determine the mixture ratio as per the coolant manufacturer's instructions.

***: The replacement period of hydraulic oil depends on the type of hydraulic oil in use. The new machine is filled with Ken stone genuine hydraulic oil 46 at the time of delivery and the hydraulic oil replacement periods described in this manual are based on the use of Ken stone genuine hydraulic oil 46. When common anti-wear hydraulic oil is used, replace the hydraulic oil once every 2,000h.

API: American Petroleum Institute

ACEA: Association eds Constructors Europeans

SAE: Society of Automotive Engineers



Periodical Replacement of Hydraulic Oil

With installed hydraulic breaking hammer, the hydraulic oil deteriorates faster than the common digging operations. Ensure to replace the hydraulic oil and oil return filter element.

- The failure to replace timely will result in damage of machine and breaking hammer hydraulic system. To prolong the lives of hydraulic devices, please timely replace the hydraulic oil and oil return filter element as per the table below.
- During the replacement of hydraulic oil, clean the oil suction filter screen.

Replacement period (Hour)

Item	Hydraulic oil	Filter element
1 st time	--	25
2 nd time	--	100
Periodic	1200(600)	200

By taking the breaking hammer operating ratio of 100% for instance. Refer to “Hydraulic Breaking Hammer” in page 8-6 for details.

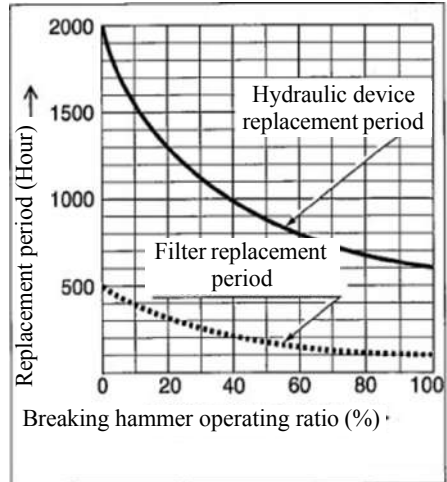

(): For the use of common anti-wear hydraulic oil.



Maintenance Service Data

List of Wearing Parts

Periodically replace the wearing parts, including filters and filter elements, as per the table below.

System	Item	Part name	Replacement period
Hydraulic system	Return oil filter		First 50 hours for new machine or every 500 hours
Hydraulic system	Ventilator		Every 1000 hours
Engine lubrication system	Engine oil filter	Filter cartridge	Replace after first 50 hours, then every 250 hours
Fuel system	Fuel filter	Filter cartridge	Every 250 hours
	Water separator	filter	Every 500 hours
Air filter system	Air filter	Primary (Outer) filter element	Every 1,000h or 6 cleaning cycles (Whichever comes first)
		Secondary (Inner) filter element	At replacement of primary filter element



Maintenance Service Data

List of Tools (If installed)

List of tools				
S/N	Name and specification	Unit	Quantity	Remark
1	Tool box	PCs	1	
2	Socket hex. wrench (4mm)	Piece	1	
3	Socket hex. wrench (5mm)	Piece	1	
4	Socket hex. wrench (6mm)	Piece	1	
5	Socket hex. wrench (8mm)	Piece	1	
6	Socket hex. wrench (10mm)	Piece	1	
7	Socket hex. wrench (12mm)	Piece	1	
8	Stud dead spanner 22*24	Piece	1	
9	Stud dead spanner 27*30	Piece	1	
10	Stud dead spanner 30*32	Piece	1	
11	Stud dead spanner 36*41	Piece	1	
12	Combination wrench 8mm	Piece	1	
13	Combination wrench 10mm	Piece	1	
14	Combination wrench 12mm	Piece	1	
15	Combination wrench 13mm	Piece	1	
16	Combination wrench 14mm	Piece	1	
17	Combination wrench 15mm	Piece	1	
18	Combination wrench 16mm	Piece	1	
19	Combination wrench 17mm	Piece	1	
20	Combination wrench 18mm	Piece	1	
21	Combination wrench 19mm	Piece	1	
22	Socket head, 10mm	Piece	1	
23	Socket head 11mm	Piece	1	
24	Socket head 12mm	Piece	1	
25	Socket head 13mm	Piece	1	
26	Socket head 14mm	Piece	1	
27	Socket head 15mm	Piece	1	
28	Socket head 16mm	Piece	1	
29	Socket head 17mm	Piece	1	
30	Socket head 18mm	Piece	1	
31	Socket head 19mm	Piece	1	Extended socket head
32	Socket head 21mm	Piece	1	
33	Socket head 22mm	Piece	1	
34	Socket head 24mm	Piece	1	
35	Socket head 27mm	Piece	1	
36	Socket head 30mm	Piece	1	Changed to 30mm
37	Curved extension rod, 12.5mm	Piece	1	
38	Short extension rod, 12.5mm	Piece	2	One long and one short each
39	Wire cutter, 200mm	Piece	1	
40	Nipper pliers, 200mm	Piece	1	
41	Ratchet wheel handle, 12.5mm	Piece	1	
42	Adjustable wrench, 300mm	Piece	1	
43	Ball hammer, 1.5pon	Piece	1	
44	Straight screwdriver, 200mm*8mm	Piece	1	
45	Phillips screwdriver, 200mm*8mm	Piece	1	
46	Grease gun, 400g	Piece	1	
47	Belt wrench, 60-140mm	Set	1	

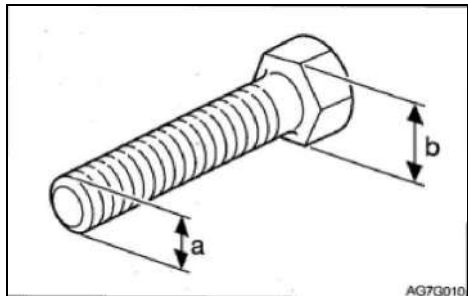
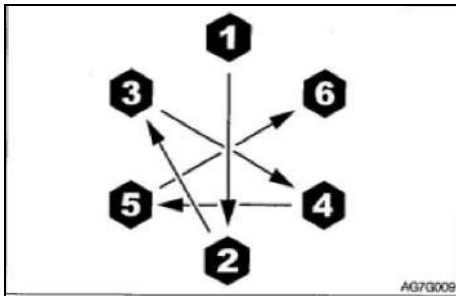

Table of Tightening Torques

Nuts and Bolts (Grade ISO10.9)

Unless otherwise specified, tighten the nuts and bolts to the torques listed in table below.

- The tightening torques for installation of plastic caps are not listed in the table below. To understand more details, please consult with your sales or service dealer. The excessive tightening torque will cause damages.
- If the replacement is required, replace with nuts and bolts of same dimensions and specifications.



Category	Width across flats (b) mm	Dimension (a) X pitch mm	Tightening torque	
			Common connection	
			N·m	Ft·lb
Coarse thread	10	M6 X 1.0	9,8 ±0,5	7, 2±0,4
	12, 13	M8 X 1.25	22,6±1,1	16,6±0,8
	14, 17	M10 X 1.5	47,1±2,4	34, 7 ±1,7
	17,19	M12 X 1.75	83,4±4,1	61,5±3,0
	19, 22	M14 X 2,0	134,4±6,7	99,1±4,9
	22, 24	M16 X 2.0	207,9±10,4	153, 3 ± 7,7
	27, 30	M20 X 2, 5	410,9±20,5	303,1 ± 15,1
Fine thread	12, 13	M8 X 1.0	24,5±1,2	18,1±0,9
	14, 17	M10 X 1.25	50±2, 5	36,9±1,8
	17, 19	M12 X 1.5	87,3±4,3	64,4 ± 3,2
	19, 22	M14 X 1.5	135, 3±6,8	99,8±5,0
	22, 24	M16 X 1.5	220,6±11	162,7 ± 8,1
	27, 30	M20 X 1.5	452, 1 ±22,6	333,4 ± 16,6

**Critical Safety Parts**

To operate the machine safely, please fulfill the periodical checking and maintenance. The following critical safety parts shall be replaced periodically to improve safety. These parts can cause serious injuries or fire accident if they are damaged.

List of Critical Safety Parts

Vehicle body		Periodically replaced critical safety part	Replacement period	
Fuel system		Fuel pipes	Every 2 years	
		Packing on fuel tank cover		
Heater		Heater hoses		
Cooling system		Rubber hoses		
Hydraulic system	Main machine	Hydraulic pipe (Pump outlet)		
		Hydraulic pipe (Pump oil suction port)		
		Hydraulic pipe (Slewing motor)		
		Hydraulic pipe (Traveling motor)		
	Working device	Hydraulic pipe (Boom cylinder pipeline)		
		Hydraulic pipe (Bucket arm cylinder pipeline)		
		Hydraulic pipe (Bucket cylinder pipeline)		
		Hydraulic pipe (Swing cylinder)		
		Hydraulic pipe (Bulldozing blade cylinder)		
		Hydraulic pipe (Span cylinder)		
		Hydraulic pipe (Pilot valve)		
		Hydraulic pipe (Auxiliary pipeline)		
	Seat Belt		Seat Belt	Every 3 years
			Anti skid plate	



The materials of the above-mentioned critical safety parts will deteriorate along with time to cause wear or deteriorated performance. It's difficult to determine the deterioration extent during periodical checking. Therefore, such parts shall be replaced with new ones to guarantee stable performance, even if such parts are still working well. Please be noted that, regardless of the replacement schedule, any part with wear symptom must be replaced immediately. Upon detection of any deformed or cracked pipe clamp, immediately replace it together with hose. Please consult with your sales or service dealer for the replacement of safety parts.

Except the critical safety parts, check and tighten the hydraulic pipes and when necessary replace.

During the replacement of hydraulic pipes, replace the O-ring and seal ring as well.

Check the fuel and hydraulic pipes as per the schedule specified by the following table.

Refer to "Maintenance".

Checking type	Checking item
Daily routine checking	Leakage of hydraulic or fuel pipe connector
Monthly checking	Leakage of hydraulic or fuel pipe connector Damage (Cracking, wear, and tear) of hydraulic or fuel pipe
Yearly checking	Leakage of hydraulic or fuel pipe connector Aging, distortion, and damage (Cracking, wear, and tear) of hydraulic or fuel pipe and/or status of hose in contact with other machine parts

**Maintenance List**

Checking and maintenance item	Page
Walk-Around Checking	
Opening of engine hood and machine hood for checking	5-16
Walk-around checking of machine	5-16
Checking in driver seat	5-16
Daily routine checking (Every 10h)	
Checking and adding of coolant	5-17
Checking and adding of engine oil	5-18
Checking of fuel level	5-18
Checking of hydraulic oil tank oil level and adding of oil	5-19
Lubrication of Working Device	5-21
After first 50h (For new machine only)	
Checking and adjustment of fan belt	5-23
Replacement of hydraulic oil return filter	5-24
Every 50h	
Checking and adjustment of track tension	5-25
Lubricate slewing support and slewing motor gears	5-26
Water drainage from fuel tank	5-27
Checking of battery electrolyte level and adding of electrolyte	5-28
Every 250h	
Checking and adjustment of fan belt	5-30
Replacement of engine oil and filter	5-30
Cleaning of air filter	5-31
Checking of accelerator control system	5-32
Cleaning of radiator fins and oil cooler fins	5-32
Replacement of fuel filter	5-33
Every 1000h	
Replace the air filter	5-35
Check and adjust the engine valve clearance	5-35
Clean the engine cooling system	5-36
Every 1500h	
Check and clean the engine fuel injector	5-39
Check the crankcase vent system	5-39
Every 2000h	
Overlap engine valve seat	5-40
Replace hydraulic oil and clean suction filter	5-40



Maintenance

Maintenance List

Maintenance List

Checking and maintenance item	Page
when needed	
Replace the teeth	5-42
Replace the bucket	5-43
Lubricate Joysticks	5-44
Check the rubber track	5-45
Replace the rubber track	5-47



Walk-Around Checking

Fulfill the following checking before the first start of engine each day.

 **Warning**

- **Before operations, fulfill the walk-around checking and when necessary repair immediately.**
 - **Before operations within the machine, please securely fix the engine hood or machine hood. Keep the engine hood and machine hood closed under windy weather or while parking the machine on a slope.**
-

Before starting the engine, patrol around the machine and remove any combustible materials around the engine. At the same time, check the machine for oil or water leakage, as well as loose or damaged nuts, bolts or wires.

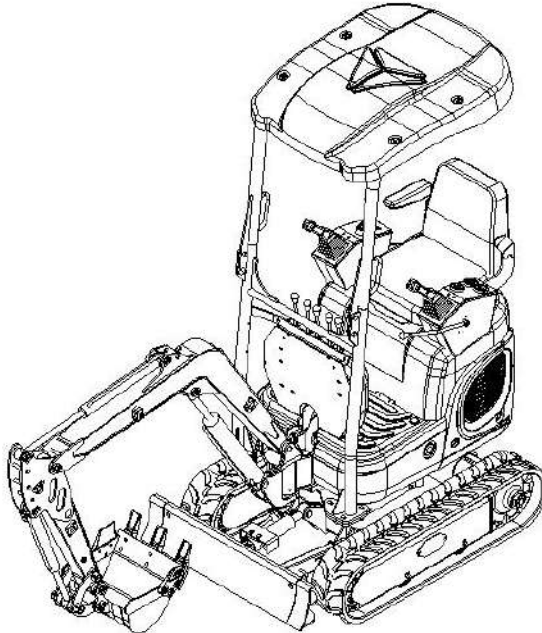



Opening of engine hood and machine hood for checking

1. Check for presence of branches, leaves, oil, and other inflammable around the engine and battery.
2. Check for presence of lubricating oil and coolant leakages around the engine.
3. Check hydraulic oil pipes, hydraulic devices, hoses, and connectors for oil leakage.

Walk-around checking of machine

1. Check lamps for presence of dusts and damages and check lamp bulbs for burnout.
2. Check hydraulic accessories and hoses for damage.
3. Check bucket, bucket teeth, and side teeth for wear, damage, and looseness.
4. Check hook, anti-slip stop block, and hook seat on bucket for presence of damage.
(Optional)
5. Check handrails, footplates, and anti-slip surfaces for damage and check for any loose bolt.
6. Check tracks and track shoes for presence of slip, check track carrier rollers, idling device, and sprocket for presence of damage and wear, and check for loose bolt.

7. Check traveling motor for oil leakage.
8. Check shelter and guard plates for damage and check for loose nuts and bolts.
9. Check exterior and interior rear view mirrors for contamination and damage and when necessary adjust.
10. Check labels for presence of dusts and damage.

Checking in Driver Seat

1. Check seat and seat belt for presence of dust and damage.
2. Check driver seat for presence of dust, oil dirt, and other inflammable.
3. Check monitor, electric devices, and switches for oil dirt, dust, and damage.



Daily routine checking (Every 10h)

Fulfill the following checking before the first start of engine each day.

 **Warning**

- Before operations, fulfill the daily routine checking and when necessary repair immediately.
- Before operations within the machine, please securely fix the engine hood or machine hood. Keep the engine hood and machine hood closed under windy weather or while parking the machine on a slope.

Checking and adding of coolant

 **Warning**

- Do not disassemble the radiator cap or drainage plug when the coolant is hot. Stop the engine, wait for the engine and radiator to cool down, and then slowly loosen and take out the radiator cap and drainage plug.
 - While handling the coolant (antifreeze), ensure to wear goggles and gloves. In event of splashing of coolant (antifreeze) into your eyes or onto your skin, clean by clean water immediately. Otherwise it will cause injuries.
-



1. Open the engine hood.
2. Check the coolant level in the water tank (1). The coolant level shall be within upper limit and lower limit. If below the lower limit, add coolant.

Adding

1. Take out the cap of water tank (1).
2. Add coolant, till the coolant level reaches upper limit of water tank (1).
Upon detection of empty water tank (1) during checking, check for presence of water leakage and then check water level of radiator (2). When necessary, add water to the radiator (2) and then add water to the water tank (1).
3. Install the cap (1).

Note: Add clean water (soft water) only to compensate the lost coolant due to evaporation. Add the coolant (antifreeze) and clean water (soft water) of specified mixing ratio only to



Daily routine checking (Every 10h)

compensate the lost coolant due to leakage.

Checking and adding of engine oil



Warning

Please stop the engine and wait for the machine to cool down before maintenance.

Checking

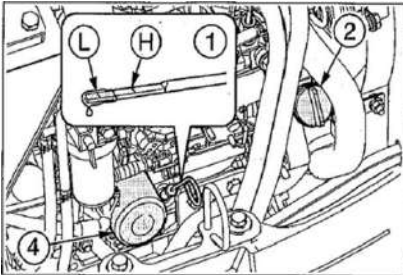

1. Open the engine hood.
2. Withdraw the engine oil dipstick (1) and wipe it dry by a rag.
3. Insert the oil dipstick (1) to the end and then withdraw again.
4. Check the oil on the oil dipstick (1). The oil level shall be within upper limit and lower limit. If below the lower limit, add oil.

Adding

1. Take out the oil filler cap (2).
2. Add oil till the oil level is within upper limit and lower limit of oil dipstick (1). Both excessive and insufficient oil levels will cause malfunction.

3. Tighten the oil filler cap (2).
4. Start the engine, run at low idling speed for 5min, and then stop the engine.
5. Check the oil level after approximately 10min.

Checking of fuel level



Warning

- Do not smoke or use open fire while handling fuel or performing the operations of fuel system.
- Do not disassemble the fuel tank cap or refuel while the engine is running or is not cooled down. Do not splash fuel to any high temperature surface of machine.
- Refuel the fuel tank in a well-ventilated place.
- Any overflow fuel shall be wiped away immediately.
- Do not top up the fuel tank. Leave an expansion space for the fuel.
- Tighten the fuel tank cap securely.
- Use correct fuel grade based on the season.



Add fuel

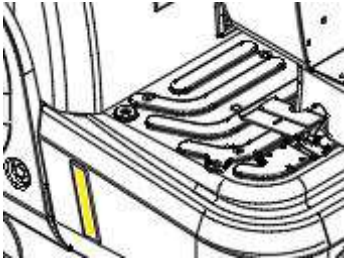

1. Check the fuel level by fuel gauge .
2. If the fuel level is low, open the fuel tank cap and add fuel.

Checking of hydraulic oil tank oil level and adding of oil



Warning

Disassembling cap or filter or disconnecting pipeline before the pressure relief of hydraulic system will probably result in out-spray of hydraulic oil.

- **Slowly loosen the ventilation plug to relieve the internal pressure of tank.**

Checking

The oil level varies along with the oil temperature. Maintain the machine and check the fuel status by the posture shown in the diagram below.

- Posture of machine for checking of hydraulic oil level

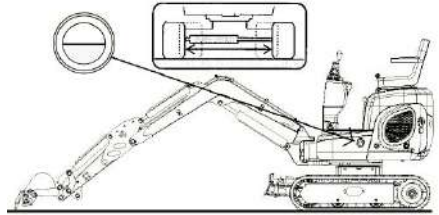

1. Start the engine and run at low speed.
2. Fully extend the track width.
3. Fully retract the cylinders (Bucket arm and bucket cylinders) and lower the bucket onto the ground.
4. Lower the bulldozing blade and then stop the engine.
5. Check the oil level by level gauge.

When the oil temperature is approximately 20°C: The oil level shall be within upper limit and lower limit. If below the lower limit, add oil.

When the oil temperature is approximately 50~80°C: The oil level shall be slightly lower than upper limit.



Add hydraulic oil



Important: While adding oil, the oil level shall not be above the upper limit. Otherwise it will damage the hydraulic circuit or cause oil spray. If the oil level is too high due to carelessness, stop the engine, wait for the hydraulic oil to cool down, and drain the excessive oil from oil drainage port.

Important: Do not forget applying pressure to the hydraulic oil tank, in order to prevent the damage of pump due to air inhalation. (If no ventilator is installed.)

1. Open the engine hood.
2. Slowly loosen the bleeding plug (2) to relieve the internal pressure and then take out the plug.
3. Add hydraulic oil, till the oil level is in the middle of level gauge (1).
4. Pressurize the hydraulic oil tank as shown in diagram below.

Note: For machines equipped with a ventilator, there is no need to pressurize.

Pressurization of Hydraulic Oil Tank

1. Start the engine and run at low speed.
2. Disassemble the bleeding plug (2) and set the safety lock handle to unlocking position.

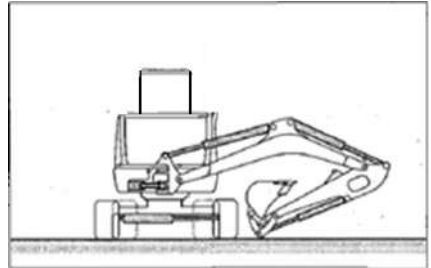

3. Fully extend the bucket, bucket arm, boom, swing, and span cylinders.
4. Stop the engine and lift up the safety lock handle to locking position.
5. Tighten the bleeding plug and then pressurize by retracting cylinders.



Lubrication of Working Device

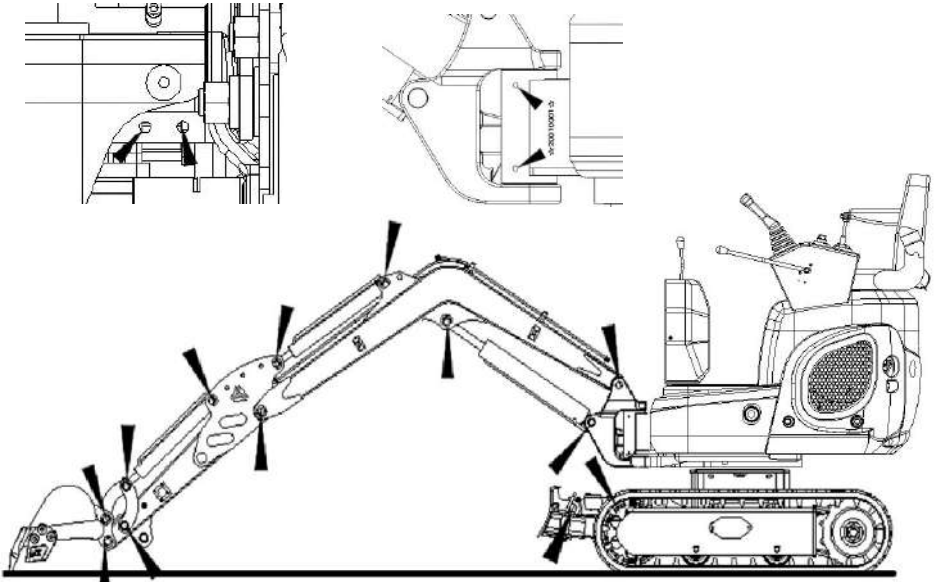

1. Maintain the machine under the status shown in above diagram, lower the working device to the ground, and then stop the engine.
2. Lubricate the grease fitting by a grease gun.
3. Wipe away excessive grease.

Records



After first 50h (For new machine only)

Checking and adjustment of fan belt



Warning

Please stop the engine and wait for the machine to cool down before maintenance. .

- The engine, exhaust pipe, radiator, hydraulic pipes, sliding parts, and many other machine parts are really hot when the engine is just stopped. Touching such parts can cause scalding.

Important: A loose belt can cause poor charging of battery, overheating of engine, or earlier wear of belt. The over-tight belt will damage the water pump or bearing and alternator drive belt.

Important: Keep the belts away from all greases.

Checking



1. Lift up and open the machine cover.

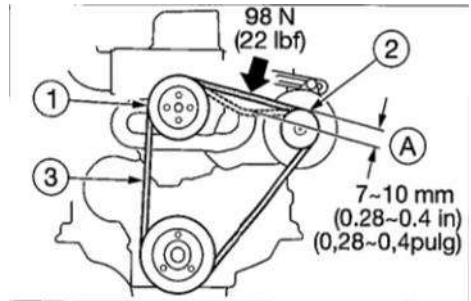

2. Check the tension (Approximately 98N) based on the centers of fan pulley (1) and alternator pulley (2).
3. Check the fan belt (3). Upon detection of any of following conditions, replace.
 - Rupture or cracking.
 - The belt is worn to touch the bottom of pulley V-grooves.
 - The belt is stretched loosely and is non-adjustable.

Adjustment

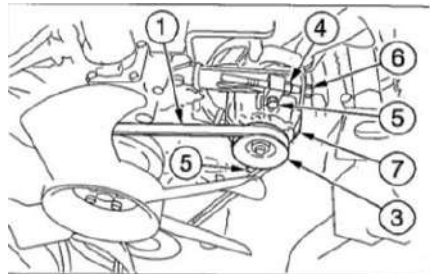

1. Loosen bolt (5) and lock nut (4).
2. Rotate the adjustment bolt (6) to move the



alternator (7) and adjust the tension of fan belt (1).

Increase tension: Clockwise

Reduce tension: Counter-clockwise

3. Tighten bolt (5) and lock nut (4).

Note: After the replacement with new belt, run the engine at low idling speed for approximately 3~5min to run in new belt and then adjust the tension.

Replacement of engine oil and filter

Refer to page 5-30“Replacement of engine oil and filter”.



Every 50h

Check and adjust track tension



Warning

- If it's necessary to operate beneath the lifted machine or working device, always use cushion woods, jack, or other firm and stable supports. Do not access the area beneath the machine or working device before it's firmly supported. This operation is especially important for the hydraulic cylinder operations.
- Guard against high pressure grease.
- In the track pensioner, the grease is injected under high pressure. If the tension is not adjusted by the following designated procedure, the grease relief valve will probably fly out to cause injuries.
- Never loosen the grease pipe fittings.
- Slowly loosen the grease relief valve. Do not rotate it for >1 turn.
- Do not place your face, arms, legs, or body in front of the grease relief valve.
- If no grease flows out when the grease relief valve is loosened, the valve is malfunctioned. Please contact a Ken stone Heavy Machinery service dealer for repairs.

Checking

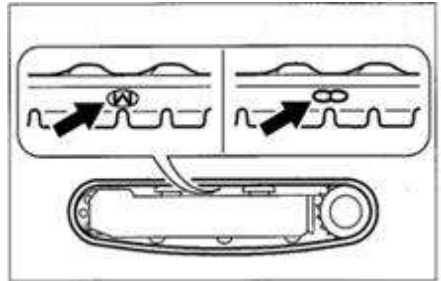

1. For rubber tracks, adjust the marking "M" at the joints to the top center of track frame.

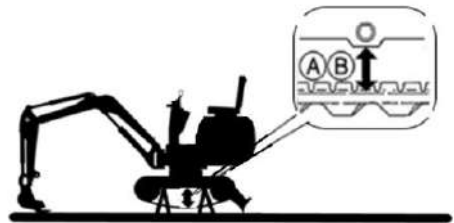

2. Lift the machine body by working device. Slowly operate the joysticks.

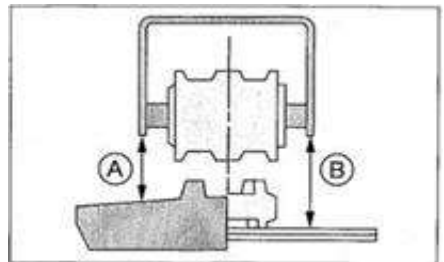



3. Check the clearance (A or B) between the frame bottom face and track top face in the middle of track frame. The clearance (A or B) shall be within following range:

(A) Rubber tracks

59~64mm

(B) Steel tracks

95 to 110mm

Adjustment

Increasing of Tension

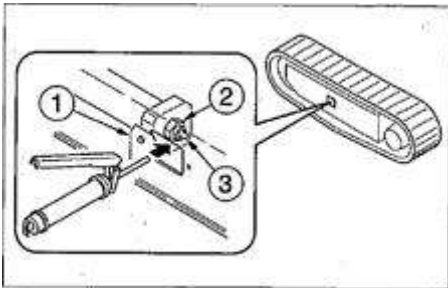

1. Take out the cover plate (1).
2. Use a grease gun to inject lubricating grease via the grease fitting (3) of grease relief valve (2).
3. Check the track tension.

Reduce tension

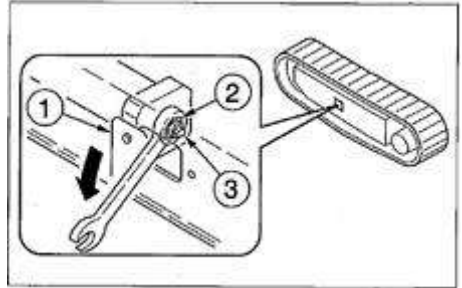

1. Remove the cover plate.
2. Slowly loosen (by one turn) the grease relief valve (2) by a wrench to drain the grease. If it's difficult to drain the grease, drive the machine back and forth.
3. Tighten the grease relief valve (2).
 - Tightening torque: 177 N·M

Lubricate slewing support and slewing motor gears



Warning

Do not slew during lubrication. Otherwise, you will probably be entangled into the machine, which is really dangerous.



Maintenance Every 50h

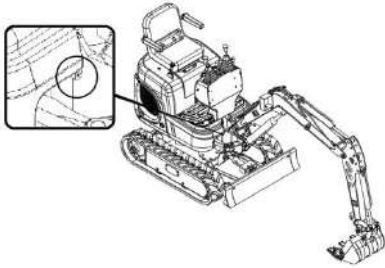

1. Stop the machine as per the posture shown in above diagram and stop the engine.
2. Lubricate the grease fitting by a grease gun.

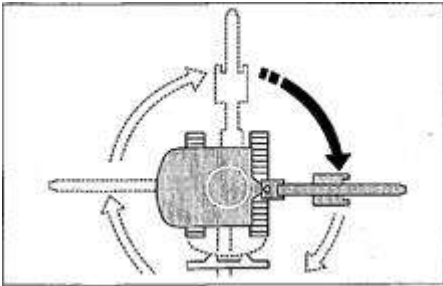

3. Start the engine, lift the bucket, and rotate clockwise for 90°.
4. Lower the bucket onto the ground and then stop the engine.
5. Repeat above steps 2~4 for 3 times.
6. Wipe away the grease drained from the slewing bearing and grease pipe.

Water drainage from fuel tank



Warning

- Do not smoke or use open fire while handling fuel or performing the operations of fuel system.
- Do not disassemble the fuel tank cap or refuel while the engine is running or is not cooled down. Do not splash fuel to any high temperature surface of machine.
- Refuel the fuel tank in a well-ventilated place.
- Do not top up the fuel tank. Leave an expansion space for the fuel.
- Any overflowed fuel shall be wiped away immediately.
- Tighten the fuel tank cap securely.
- Use correct fuel grade based on the season.

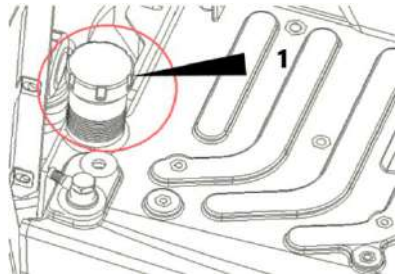

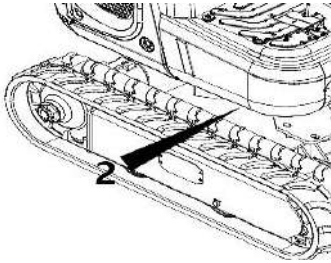

Start the machine only after draining.

1. Slew the upper frame to a position easy for water drainage.
2. Lift up and open the hood, Take out the fuel tank cap (1).
3. Place a box beneath the water drainage plug (2).
4. Loosen the water drainage plug (2) to fully drain the water and the deposits from the tank.
5. Tighten the water drainage plug (2).
6. Tighten and lock the fuel tank cap (1).
7. Exhaust air.

Air exhausting of Fuel System

Refer to page 6-8“Air exhausting from Fuel System”.

Note: The air content in the fuel system will cause start failure or start difficulty of engine.

Bleed the air by same procedure described above when the fuel tank is empty.

Checking of battery electrolyte level and adding of electrolyte



Danger

- Do not use the battery when the electrolyte level is below the lower limit. Otherwise it will speed up the internal aging and shorten the life of battery. In addition, it can lead to burst (explosion).
- The battery can generate inflammable hydrogen to probably cause explosion. Keep away from fire sources including open fire, spark, and ignited cigarette.
- Clean the area above electrolyte level marking by a wet cloth and check the level. Do not clean by a dry cloth, otherwise it can cause electrostatic accumulation and combustion or explosion.



Warning

- During the operations of battery, wear goggles and protective clothing.
- Do not fill the distilled water till the level is above the upper limit. Otherwise the electrolyte will leak out. The contact with such electrolyte can harm your skin or corrode the machine parts.
- The battery contains sulfur acid. The accidental touch will harm your eyes or



Maintenance Every 50h

skin.

- **In event of accidental contact with eyes, immediately flush by clean water and quickly seek for medical treatment.**
 - **In event of accidental swallowing, drink a lot of water or milk and immediately seek for medical treatment.**
 - **If the sulfur acid comes into contact with your skin or clothing, immediately flush by a lot of water.**
-

Checking

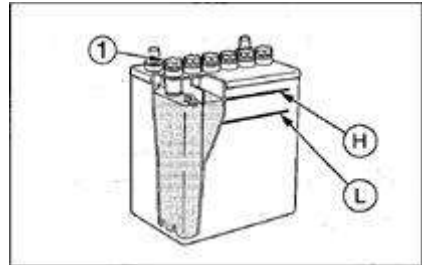

1. Open the maintenance cover.
2. Check the fluid level. The fluid level must be between upper limit (H) and lower limit (L). If not, add distilled water till the fluid level reaches upper limit (H).
3. Check terminals for looseness and contamination.

Adding

If the adding of distilled water is required, add water before start of operations, in order to prevent freezing.

1. Take out the cap (1) and add distilled water till the upper limit (H) is reached.
2. Clean the ventilation port on the cap and securely tighten the cap (1).



Every 250 hour

Checking and adjustment of fan belt

Refer to page 5-23 “Checking and adjustment of fan belt”.

Replacement of engine oil and filter



Warning

Please stop the engine and wait for the machine to cool down before maintenance. .

- The engine, exhaust pipe, radiator, hydraulic pipes, sliding parts, and many other machine parts are really hot when the engine is just stopped. Touching such parts can cause scalding.
- The engine oil is really hot. Take cautions not to touch the hydraulic oil while loosening engine hood or connector. Operating the machine in such case will cause scalding and injuries.

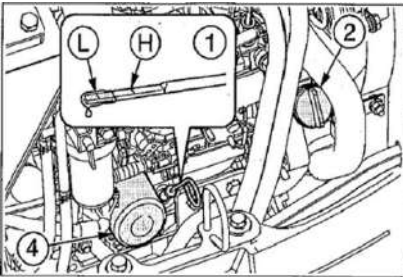

1. Open the engine hood and take out the oil filler port (2).

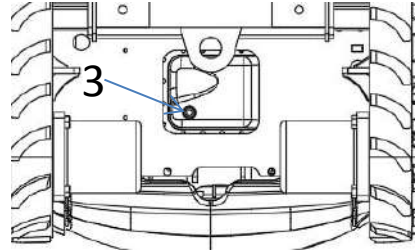

1. Open the engine cover and remove the fuel filler opening (2).
2. Place a tray under the drain plug (3) for the waste oil.
3. Remove the oil drain plug (3) to drain the oil.
Important: Check for metal powder in the waste oil. If it contains a large amount of metal powder, please consult your sales or service agent.
4. Press the oil drain plug (3) and tighten it with a wrench.
5. Use the oil filter wrench to turn the filter (4) counterclockwise to remove it.
6. Clean the installation surface of the filter housing.
7. Apply a small amount of oil to the gasket of the new filter.
8. Install the new filter manually.
9. After the filter gasket touches the mounting surface, tighten one more turn (use an oil filter wrench). (Tightening torque with an



Maintenance Every 250h

oil filter wrench: 19.6 to 23.5N·m).

10. Add lubricating oil between the upper limit (H) and lower limit (L) of the oil dipstick (1). If the oil level is too low or too high, it will cause problems.
11. Tighten the fuel filler cap.
12. Start the engine, run it at a low idle speed for 5 minutes and turn off the engine.
13. After about 10 minutes, check the oil level.

Cleaning of Air Filter

Warning

- Please stop the engine and wait for the machine to cool down before maintenance.
- The engine, exhaust pipe, radiator, and many other machine parts are really hot when the engine is just stopped. Touching them will cause scalding.
- While using compressed air, please wear necessary protection appliances, including goggles and filtration mask, as the metal fragments and other objects will splash to cause accidents of serious harms.

Important: Take cautions not to scratch the filter element. Do not use any damaged filter element.

Important: During the operations under dusty environment, please daily fulfill the checking and maintenance for the machine.

Important: Ensure to steadily install the filter element and dust cover. Otherwise, the ingress of dusts into the cylinders will damage the engine.

1. Open the engine hood.

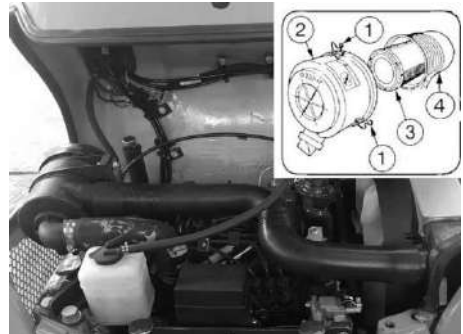

2. Loosen the clamp (1) and take out the dust collector (2).

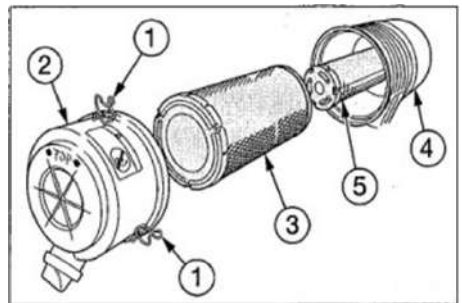

3. Clean the inside of dust collector (2).
4. Take out the primary filter element (3).
5. Cover the inlet and outlet on the back of



Maintenance Every 250h

body (4) by cloth or tape to guard against ingress of dusts.

<If the secondary filter element is installed>

To prevent the ingress of dusts into engine, do not take out the secondary filter element (5).

6. Clean the inside of housing (4).

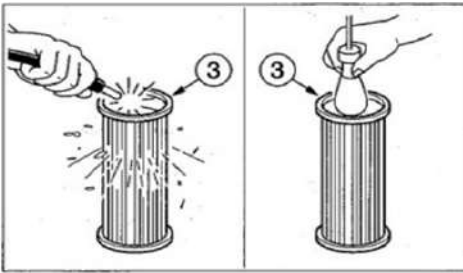

7. Clean primary filter element (3) by dry compressed air (294~490kPa). Firstly, blow along the wrinkles from the inside of filter element. Then blow from outside and finally blow from inside.
8. Illuminate the inside of primary filter element (3) by a lamp to check. Upon detection of any pinhole or dirt, replace.
9. Remove the cloth or tape used in step 5.
10. Install the primary filter element (3).
11. Install the dust collector (2) by facing upward the “↑TOP↑” and then secure it by clamp (1).

Checking of accelerator control system

- The accelerator joystick and the speed regulator on the engine side are connected by wiring. Check the wires at their fixing positions for presence of stretching and looseness.
- If the wires at their fixing positions are stretched or loose, there probably has a malfunction.
- The replacement and adjustment of wires require experiences. Please ask your sales or service dealer for operations.

Cleaning of radiator fins and oil cooler



Warning

While using compressed air, please wear necessary protection appliances, including goggles and filtration mask, as the metal fragments and other objects will splash to cause accidents of serious harms.

Important: Take cautions not to damage the radiator fins during cleaning.

- **While using compressed air or high pressure water, ensure that the pressure is no higher than 200kPa and keep the air nozzle from the radiator for a sufficient spacing.**

Important: While cleaning by water, please cover the electric system against water



Maintenance Every 250h

ingress.

Important: During the operations under dusty environment, please daily fulfill the checking and maintenance for the machine.

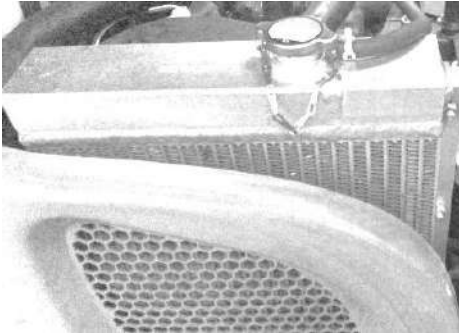

1. Open the engine cover..
2. Blow compressed air towards the radiator fins to remove the adhered dusts and mud.

Replacement of Fuel Filter



Warning

- Do not smoke or use open fire while handling fuel or performing the operations of fuel system.
- Stop the engine in a well-ventilated place and wait for the machine to cool down before maintenance.
- Any overflowed fuel shall be wiped away immediately.



1. Open the engine hood.
2. Rotate the filter (1) counter-clockwise by a filter wrench to take it out.
3. Clean the mounting surfaces of filter housing.
4. Apply a thin film of fuel to the washer of new filter housing.
5. Manually install new filter.
6. After the filter washer comes into contact with the mounting surface, tighten the filter further for one turn.
(Tightening torque by filter wrench: 20~24N.m).
7. Exhaust the air.

Refer to page 6-8“Air Exhausting from Fuel System”.

Records



Every 1000h

Replace the air filter



Warning

Please stop the engine and wait for the machine to cool down before maintenance. .

- The engine, exhaust pipe, radiator, and many other machine parts are really hot when the engine is just stopped.

Touching such parts can cause scalding.

Important: Do not use a wrinkled filter element or a filter element with damaged washer or seal ring.

Important: Ensure to steadily install the filter element and dust cover. Otherwise, the ingress of dusts into the cylinders will damage the engine.

1. Open the engine hood.

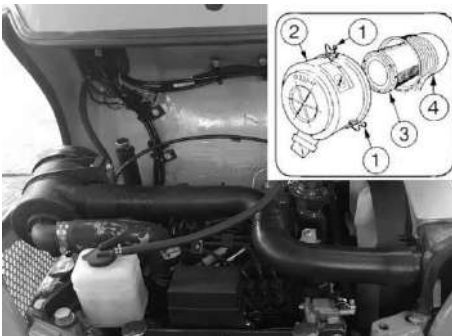

2. Loosen the clamp (1) and take out the dust collector (2).
3. Clean the inside of dust collector (2).

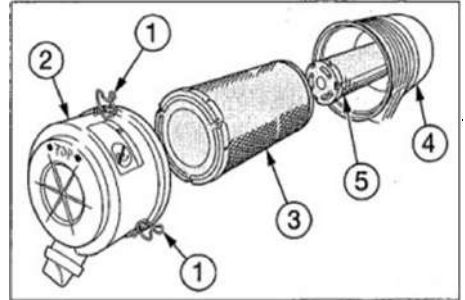

4. Take out the primary filter element (3).
5. Cover the inlet and outlet on the back of body (4) by cloth or tape to guard against ingress of dusts.
6. Clean the inside of housing (4).
7. Remove the cloth or tape used in step 5.
8. Install new filter element.
9. Install the dust collector (2) by facing upward the “↑TOP↑” and then secure it by clamp (1).

Checking and Adjustment of Engine Valve Clearance

These operations require experiences. Please ask your sales or service dealer for operations.



Cleaning of Engine Cooling System



Warning

- Please stop the engine and wait for the machine to cool down before maintenance. .
- The engine, exhaust pipe, radiator, and many other machine parts are really hot when the engine is just stopped. Touching such parts can cause scalding.
- The engine coolant is also under high temperature and high pressure when the engine is just stopped. Take special cautions while loosening the cap or plug. Operating the machine in such case will cause scalding and injuries by splashing high temperature coolant.
- If the maintenance requires the running of engine, assign two operators for teamwork and keep contact with each other.
- One operator must sit in the driver seat to get ready to stop the engine immediately when necessary. This operator must pay special attention not to touch any joystick or pedal, unless it's absolutely necessary.
- The other operator for the maintenance must keep the body and clothing away from motion parts of machine.

- While the engine is running, it's really dangerous standing behind the machine, as the machine probably moves suddenly. While the engine is running, never stand behind the machine.
- Do not disassemble the radiator cap or drainage plug when the coolant is hot. Stop the engine, wait for the engine and radiator to cool down, and then slowly loosen and take out the radiator cap and drainage plug.

During cleaning, if the coolant temperature is low, the thermostat will be closed and the coolant will not flow within the radiator. Before cleaning, heat up the coolant to at least 90°C.

1. Open the engine hood.



2. Slowly loosen the radiator cap (3) to relieve the internal pressure and then take out the cap.



Maintenance Every 1000h

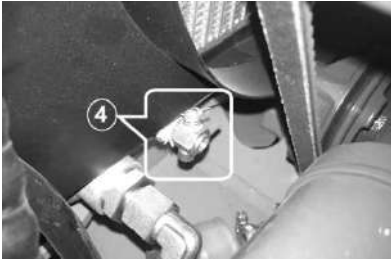

3. Place a tray beneath the water drainage plug (4) to collect the used coolant and then loosen the water drainage plug (4) to drain the coolant.
4. Tighten the water drainage plug (4).
5. Add running water through the water filler port into the radiator, till the water level reaches the top of filler port. Add the water slowly and easily to prevent the ingress of air into radiator.
6. Install the radiator cap (3).
7. Start the engine and run the engine at a speed slightly higher than the low idling speed. Heat up the water temperature to at least 90°C, open the thermostat, and then run the engine for approximately 10min.
8. Stop the engine, wait for the coolant to cool down, and then take out the drainage plug (4) to drain the water.
9. After water drainage, clean the cooling system by detergent. Use the detergent as per the attached operation instructions of the detergent.
10. Repeat steps 4~8 to clean the cooling system.
11. Tighten the water drainage plug (4).
12. Add new coolant (Mixture of antifreeze and running water) through filler port to the radiator, till the radiator is full. Add the coolant slowly and easily.
13. Install the radiator cap (3).
14. Warm up the engine. Use instruments to check the cooling system for presence of abnormality.
15. Increase the water temperature to at least 90°C. Then, open the thermostat and run the engine for approximately 10min.
16. Stop the engine, wait for the coolant to cool down, and then check the coolant level in the radiator.
17. Install the radiator cap (3).
18. Clean the inside of water tank (1) and add coolant, till the water level reaches upper limit (H).
19. If the coolant is replaced, re-check the coolant level after the operations of machine.

Once the machine starts operations, the coolant is distributed to the whole system so that the coolant level drops. Add the coolant to compensate the consumed coolant.

Records



Maintenance Every 1500h

Every 1500-hour

Checking and Cleaning of Engine Fuel Injector Nozzles

These operations require experiences. Please ask your sales or service dealer for operations.

Checking of Crankcase Ventilation Hole System

These operations require experiences. Please ask your sales or service dealer for operations.



Every 2000h

Connection of Engine Valve Seats

These operations require experiences. Please ask your sales or service dealer for operations.

Replacement of Hydraulic Oil and Cleaning of Oil Suction Filter Screen



Warning

- **Please stop the engine and wait for the machine to cool down before maintenance. .**
- **The engine, hydraulic system and most of parts are very hot when the engine stalls. You may get scalded if you touch them.**
- **The hydraulic oil is also under high temperature and high pressure. Take cautions not to touch the hydraulic oil while loosening engine hood or connector. Operating the machine under such condition will cause out-spray of hot oil to result in scalding and**
- **Disassembling cap or filter or disconnecting pipeline before the pressure relief of hydraulic system will probably result in out-spray of hydraulic oil.**
- **Slowly loosen the bleeding plug to relieve the pressure of oil tank.**

- **While disassembling connector or plug or disconnecting hose, stand on one side, loosen slowly to gradually relieve internal pressure, and then take out.**

1. Adjust the machine to the hydraulic oil level checking status.

Refer to page 5-19“Checking of hydraulic oil tank oil level and adding of oil”.

2. Lift up the safety lock handle to the locking position.

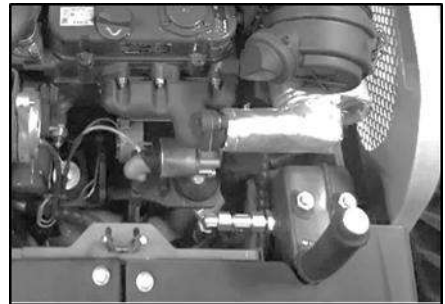

3. Lift up and open the engine cover.
4. Slowly loosen the air plug (7) to reduce the internal pressure, and then lower the plug.
5. Place a tray under the drain plug (3) for waste oil.
6. Loosen the oil plug (3) and drain the hydraulic oil.
7. Loosen the hose strap and remove the hose from the flange (1).
8. Loosen the bolts and take out the flange (1).

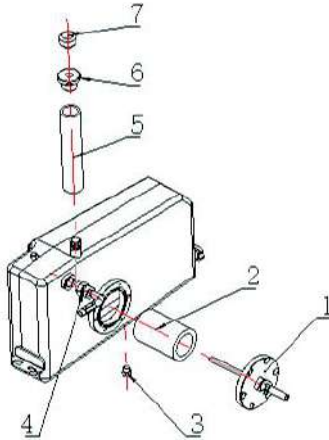

9. Loosen the bolt, remove the suction filter element (2), and clean it.
10. Clean the inside of the hydraulic oil tank.
11. Replace the bleed plug (7) (if equipped).
12. Install the suction filter element (2) on the flange (1).
13. Install the flange (1) back to its original position.
14. Tighten the oil drain plug (3).
15. Remove the rubber plug (6).
16. Fill the rubber tube (5) with hydraulic oil to the center of the round oil mark.
17. Install the hose back to the original position of the flange (1) and tighten it.
18. Pressurized hydraulic oil tank. (If not equipped with a breather, please refer to "Pressurized Hydraulic Oil Tank" on page 5-20)

19. Install the rubber plug (6), and then install the bleed plug (7).
20. Exhaust the air from the hydraulic oil circuit as described in the "Exhaust" section below.
21. Adjust the machine to the hydraulic oil level check posture, and check the oil level after the oil temperature drops.

(For details, please refer to "Checking of hydraulic oil tank oil level and adding of oil" on page 5-19)

Air Exhausting

Important: After the replacement of hydraulic oil, bleed the air from hydraulic pipelines and hydraulic devices. Otherwise, the hydraulic devices will probably be damaged.

Cylinders

1. Start the engine and run at low idling speed for 10min.
2. Keep the engine running at low idling speed, extend and retract all cylinders for 4~5 times, but take caution not to telescope any cylinder to the end.
3. Run the engine at high speed, extend and retract all cylinders for 4~5 times, but take caution not to telescope any cylinder to the end.
4. Restore the engine to low idling speed, extend and retract all cylinders for 4~5 times, and always telescope to the end.



Maintenance As Necessary

As necessary

Replace bucket teeth

Replace the bucket teeth when the tooth sleeves are worn. Do not wait for the bucket to be damaged before replacement.

Warning



- **Before the maintenance or repairs beneath the machine, lower all movable working devices onto the ground or lowest position.**
- **During the repairs and replacements of bucket teeth or side teeth, to prevent the accidental movement of machine, securely fix the working device.**
- During the use of hammer, the pins and the metal fragments will probably fly out. It will probably cause serious personal harms.
- While hammering hard metal parts such as tooth pins, bucket teeth, side teeth, and bearings, please wear protective articles including goggles and gloves.
- While hammering tooth pins and bucket teeth, ensure there is no person in surrounding area.
- During operations, the non-authorized personnel are prohibited to access the working zone.

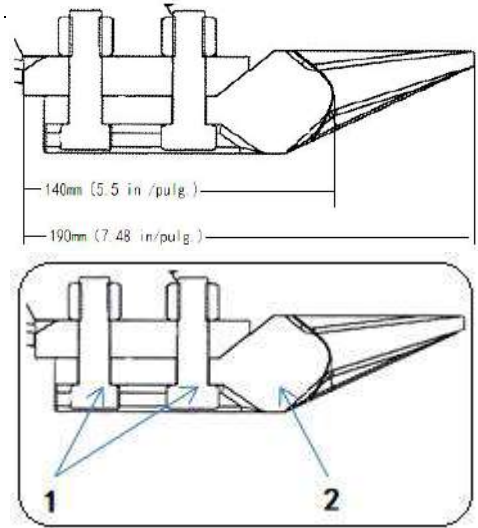

If the teeth are worn down to 140 mm, replace them.

Disassemble

1. Clean the bucket and park the machine on a flat, firm and safe ground.
2. Lay the bottom of the bucket flat, and pad the bottom with spacers to take out the bolts (1).
3. Remove the starting key, and then check whether the bucket is stable.
4. Remove the bolt (1).
5. Replace the bucket teeth (2).

Installation

1. Clean the area for installation of bucket



Maintenance As Necessary

tooth. If there is any soil or mud in this area, the bucket tooth and tooth sleeve probably can't be inserted completely.

2. Place the bucket tooth into the bucket.
 3. If the bucket tooth is insecure, please insert a shim to reduce the gap.
 4. Insert the bolt from outer side of bucket and tighten by nut.
- Tightening torque: 102 N.m.

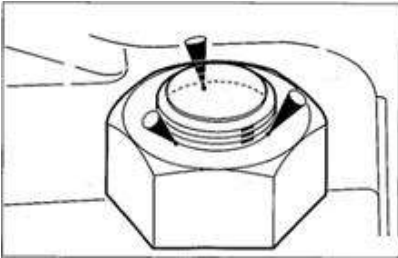

5. Rivet the bolt by a press or perform three-point welding at the threaded portion (Nut end).

Replacement of Bucket



Warning

- Before the maintenance or repairs beneath the machine, lower all working devices onto the ground or lowest position.
 - If the maintenance requires the running of engine, assign two operators for teamwork and keep contact with each other.
 - One operator must sit in the driver seat to get ready to stop the engine immediately when necessary. This operator must pay special attention not to touch any joystick or pedal, unless it's absolutely necessary.
 - The other operator for the maintenance must keep the body and clothing away from motion parts of machine.
 - During the use of hammer, the pins and the metal fragments will probably fly out. It will probably cause serious personal harms.
 - While hammering hard metal parts such as tooth pins, bucket teeth, side teeth, and bearings, please wear protective articles including goggles and gloves.
 - While hammering tooth pins and bucket teeth, ensure there is no person in surrounding area.
 - While aligning pinholes, always check by visual observation. Do not insert your finger into pinholes, otherwise your finger will probably be lost.
-



Maintenance As Necessary

Disassembling

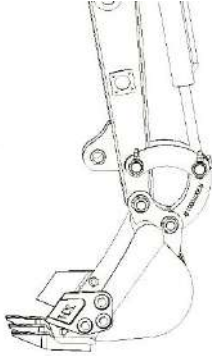

1. Lower the bucket steadily onto the ground as shown in above diagram.

Note: While disassembling the tooth pin, adjust the bucket position in such manner that the bucket barely comes into contact with the ground. If the bucket is steadily on the ground, the resistance will be really high so that it's difficult to disassemble the tooth pin.

2. Place the safety lock handle to locking position and stop the engine.

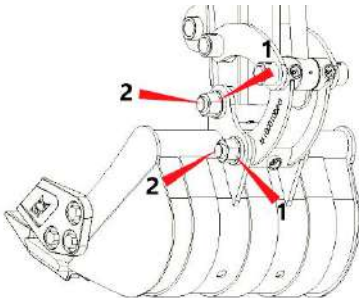

3. Unfasten the fastening nut (1) and remove it.
4. Use a hammer to knock the tooth pin (2) off the bucket.
5. Remove the bucket.

Installation

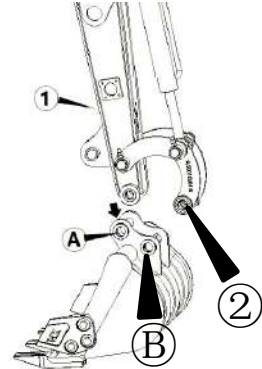

1. Align the pin hole (A) on the bucket with the pin hole on the stick ①, install the tooth pin and the fastening nut.
2. Operate the cylinder, align the pin hole (B) on the bucket with the pin hole on the connecting rod ②, and install the tooth pin and the fastening nut.

Lubrication of Joysticks

Warning



Adjust the machine to stop status, stop the engine, and withdraw and properly preserve the starter key. Otherwise, the machine will probably move suddenly to cause serious injuries or deaths.

In event of inflexible operation of any joystick, please add oil for lubrication.



Joysticks

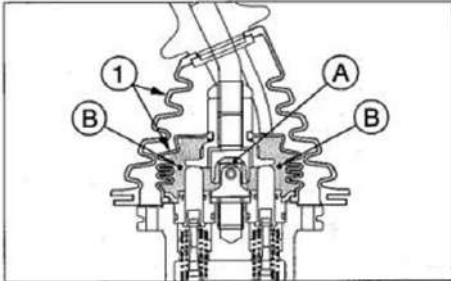

1. Remove the lower base part of the sheath (1) and turn it up.
2. Wipe off the old grease.
3. Spray grease to points (A) and (B).
4. Put the sheath (1) back in place.



Checking of Rubber Tracks

If the status of rubber tracks is as shown in the diagram below, please repair or replace. For detailed repair or replacement, please consult with your sales or service dealer.

Rubber Tracks

If any track is stretched and non-adjustable, please replace the track.

(1) Rubber bump

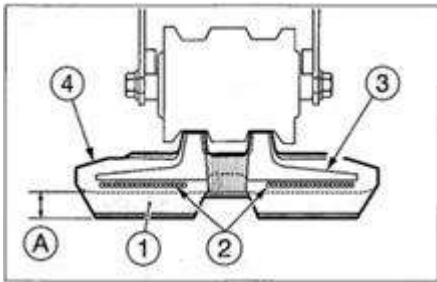

If the height (A) is $\leq 5\text{mm}$, replace.

(2) Wire rope

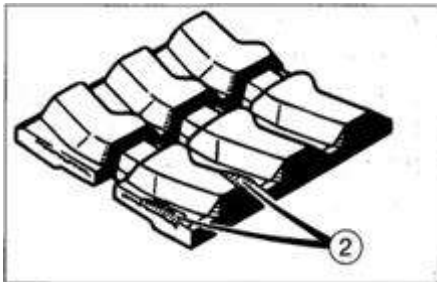

If two or more segments of the wire rope are exposed, please replace.

If more than half of the side face of wire rope is cut, please replace.

(3) Metal core

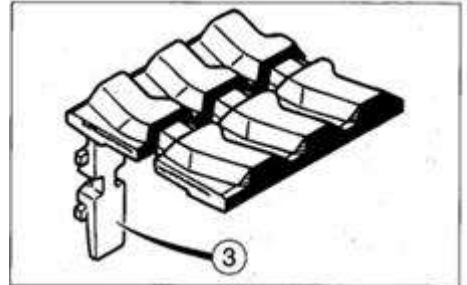

Replace even if only one metal core falls off.

(4) Rubber

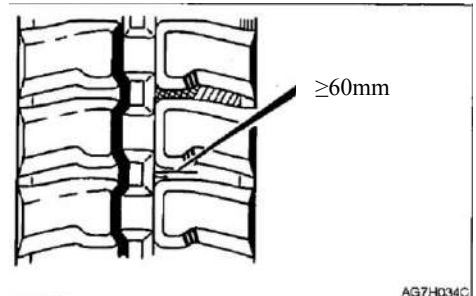

AG7H034C1

If the cracking length is $\geq 60\text{mm}$, repair. If the wire rope is visible, repair as soon as possible, regardless of the cracking length.



Replacement of Rubber Tracks



Warning

- If it's necessary to operate beneath the lifted machine or working device, always use cushion woods, jack, or other firm and stable supports. Do not access the area beneath the machine or working device before it's firmly supported.
- If the maintenance requires the running of engine, assign two operators for teamwork and keep contact with each other.
- One operator must sit in the driver seat to get ready to stop the engine immediately when necessary. This operator must pay special attention not to touch any joystick or pedal, unless it's absolutely necessary.
- The other operator for the maintenance must keep the body and clothing away from motion parts of machine.

Disassembling

1. Completely loosen the tension of rubber tracks.
Refer to page 5-25 "Check and adjust track tension".



2. Lift the machine body by working device.

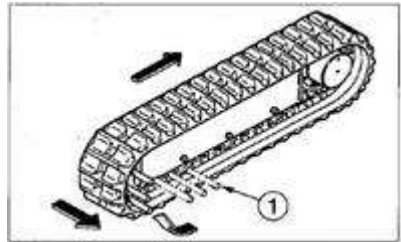

3. Place a steel tube (1) in the rubber track and rotate the sprocket slowly towards opposite direction.
4. Rotate the sprocket till the steel tube (1) closes to the pensioner and the rubber track is lifted off the pensioner and then stop the rotation of sprocket.
5. Laterally slide the rubber track to take out it from track frame. Take out the other rubber track by same procedure.



Maintenance As Necessary

Installation

1. Lift the machine body by working device.

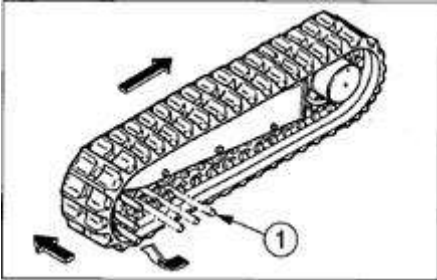

2. Place rubber track on the sprocket.
3. Place a steel tube (1) in the rubber track and rotate the sprocket slowly towards opposite direction.
4. Rotate the sprocket till the steel tube (1) closes to the pensioner and the rubber track is lifted off the pensioner and then stop the rotation of sprocket.
5. Slide inward the rubber track to install it onto the pensioner and then pull out the steel tube.
6. Check rubber track for secure installation on sprocket and pensioner.
7. Tension the rubber track to standard tension.
Refer to the “Checking and adjustment of track tension” in page 5-25 for details.
8. Install the other rubber track by same procedure.



Maintenance during Long-Time Parking

Parking Procedure

If it's necessary to park the machine for ≥ 30 days, please park the machine indoors. If it's necessary to park outdoors, please park the machine on a wood-paved level ground and cover the machine by water-proof cap to keep dry.

1. Clean the machine.
2. Check for oil/water leakage and cracking and check for any loose nut or bolt.
3. Refuel and replace hydraulic oil and lubricating oil.
4. To prevent rusting and freezing, replace the engine coolant with long-life coolant (LLC).

Refer to page 5-35 "Cleaning of radiator fins and oil cooler fins".

5. Lubricate the grease fitting by a grease gun.
6. Fully retract the bucket and bucket arm cylinders and lower the bucket and bulldozing blade onto the ground.
7. Apply anti-rusting oil to the hydraulic cylinders.
8. Disconnect the negative cable of battery and cover the battery to guard against freezing.

During Parking



Warning

- Do not operate the machine in an enclosed place with poor ventilation.
- If the natural ventilation is not possible, install ventilation fan, fan, extended exhaust pipe, or other ventilation device.

1. To prevent rusting, operate the machine once a month to circulate the oil throughout whole system.
2. Check the battery and when necessary charge the battery. Please ask your sales or service dealer for charging.

Start of Machine after Parking

Important: If the above-mentioned

"Parking procedure" is not followed during the long-time parking of machine, please consult with your sales or service dealer before restarting the machine.

1. Wipe away the lubricating oil from the piston rods of the hydraulic cylinders.
2. When necessary, add lubricating oil or grease.

Reuse of Engine

1. Fulfill the daily checking.
2. Pre-lubricate the engine before start.
 - a. Crank the engine for 15s and notice to keep the fuel system closed to prevent start of engine.



- b. Stop for 30s.
 - c. Repeat this procedure, till the engine is already cranked for 1min in total.
This can enable the sufficient oil circulation throughout the lubrication system of engine.
2. Get ready the fuel system.
 3. Start the engine. Idle the engine for approximately 15min and then:
 - Check for normal oil pressure.
 - Check for leakage of fuel, engine oil, and coolant and check indicator lamps and/or level gauge for normal functioning.
5. Avoid operating for a long time at minimum or maximum engine speed or operating the loaded residue within the first loading hour.

Troubleshooting





Symptoms that are not malfunctions

The following symptoms are not malfunctions.

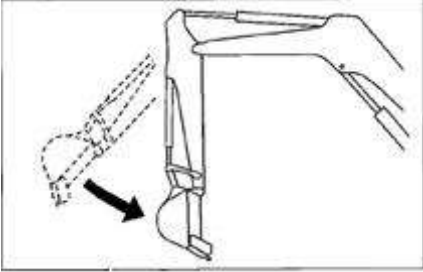

- With engine running at low speed, when the arm reaches a nearly vertical position, its retraction speed will drop shortly.

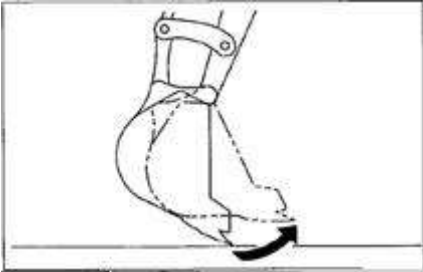

- With engine running at low speed, when the bucket teeth reach a nearly horizontal position, its movement speed will drop shortly.
- A noise of slewing motor can be heard at the start and end of slewing.

- A noise of traveling motor can be heard when the machine stops suddenly during high speed traveling.
- A noise of control valve can be heard when the working device is subject to excessive external force or moves to the end of travel.
- The operations of the machine are more labor some when an attachment heavier than the standard bucket arm or bucket is installed.



Engine Overheating

Warning

- If the steam overflows from the engine, do not open the engine hood or machine hood. The steam or hot water will probably spray out to cause scalding.
- Do not disassemble the radiator cap or drainage plug when the coolant is hot. Stop the engine, wait for the engine and radiator to cool down, and then slowly loosen the radiator cap to relieve the internal pressure.
- Please stop the engine and wait for the machine to cool down before maintenance.

The following symptoms indicate overheating.

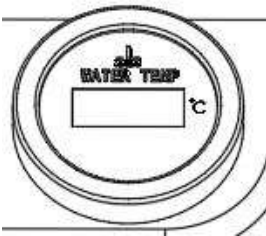

- Engine water temperature should be $<105^{\circ}\text{C}$
- Steam came out of the engine room.

Remedy procedure

1. Park the machine on a safe place.
2. Check whether the steam overflows from the closed engine hood or machine hood.
3. If the steam overflows from engine compartment, immediately stop the engine and contact your sales or service dealer for repair. If no steam overflows, run the engine at low idling speed to cool down the coolant.
4. When the water temperature is less than 105°C , turn off the engine.
5. After the engine cools down, immediately take the following checking and remedy measures.

Loose fan belt ... Refer to page 5-23 for adjustment.

Low coolant level ... Refer to page 5-17 for adding of coolant.

Water leakage ... Repair.

Dirty radiator fins ... Refer to page 5-32 for cleaning.

Deposits in cooling system... Refer to page 5-36 for cleaning.

If the malfunction still exists after the above-mentioned remedy procedures are taken, please contact your sales or service dealers for repairs.



Troubleshooting No Battery Power

No Battery Power

The following symptoms indicate no battery power.

- No rotation of starter motor or start failure of engine.
- Low volume of horn.

Remedy procedure

Start the engine by the booster battery on other machine (booster machine) and jumper cable.



Warning

- To start the engine by jumper cable, ensure to connect the cable by correct procedure. The improper use of jumper cable will result in battery explosion or unexpected machine motions.
- The booster machine and the machine with depleted battery are prohibited for mutual contact.
- The positive (+) and negative (-) clamps of the jumper cable are prohibited for mutual contact.
- During connection, firstly connect the jumper cable to positive (+) terminal. During disconnection, firstly disconnect the cable from negative (-) terminal.
- Connect the last clamp of jumper cable to a point as far as possible from the battery.
- Always wear goggles while using jumper

cable to start engine.

Important: The jumper cable and clamps in use shall be suitable to the battery capacity. Do not use any damaged or corroded jumper cable or clamp.

Important: Ensure the same capacity for the battery on the rescue machine and the battery on malfunctioned machine.

Important: Ensure to connect the cable clamps securely.

Connection of Jumper Cable

Important: Place the starter keys of both rescue machine and malfunctioned machine to OFF.

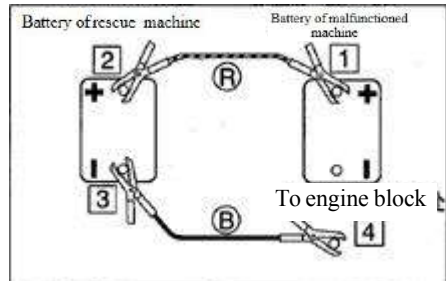

1. Connect a clamp of jumper cable (R) to the positive (+) pole of malfunctioned machine.
2. Connect the other jumper cable clamp (R) to the booster (+).
3. Connect the jumper cable clamp (B) to the charger (-).
4. Connect the other clamp of jumper cable



Troubleshooting No Battery Power

(B) to the engine support of the malfunctioned machine. Connect the clamp to a point as far as possible from the battery.

After Start of Engine

1. Check and ensure that the wire clamps are already connected securely to various terminals.
2. Start the engine of rescue machine and run it at high speed.
3. Start the engine of the malfunctioned machine.

Disconnection of Jumper Cable

After the successful start of the engine of malfunctioned machine, disconnect the jumper cable in reverse sequence of the connection procedure.

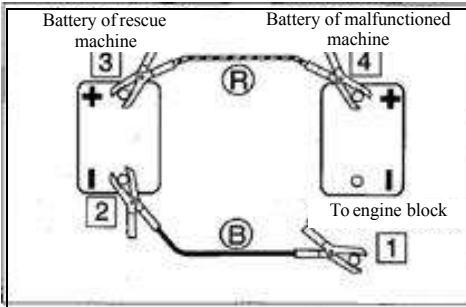

1. Disconnect the clamp of jumper cable (B) from the engine support of malfunctioned machine.
2. Disconnect the other jumper cable (B)

from the charger (-).

3. Disconnect the jumper cable (R) clamp from the charger (+).
4. Disconnect the jumper cable clamp (R) from the uncharged machine (+).

Recharging

Please ask your sales or service dealer to recharge the depleted battery.



Troubleshooting Burnout of Fuse

Burnout of Fuse

If a lamp fails to turn on or the electronic system fails to work, the fuse is probably burnt. Check the fuse.

Checking and Replacement of Fuses



Warning

If a fuse is burnt again shortly after replacement, the electronic system is probably malfunctioned. The improper repair will probably cause fire danger. If the consultation is required, please contact your sales or service dealer.

1. Rotate the starter key to OFF to stop the engine.
2. Open the engine hood.

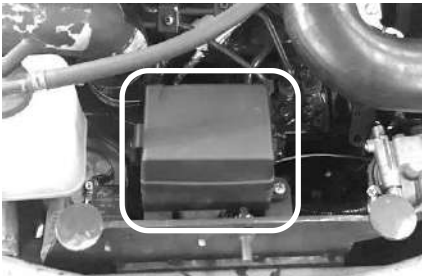

1. Open the fuse case cover (1).
2. Check fuses for burnout.

Burnout

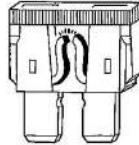

Normal

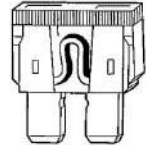

3. If a fuse is burnt, please replace with spare fuse of same specification.

Layout and protected circuits of fuses

Current	Circuit
20A	Rectifier
30A	Start signal
30A	Electric lock/preheat relay
10A	Working lamp
30A	Spare
10A	Spare

Current	name
12V60A	NO backup relay
12V60A	NO start relay
12V40A	NO charge relay
12V40A	NO lamp relay



Troubleshooting **Burnout of Fuse**

Checking of Fuses

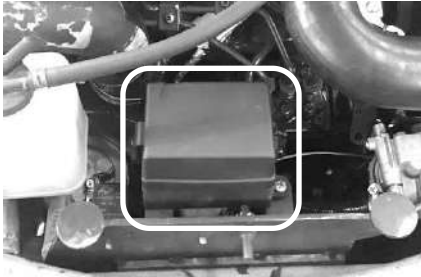

If the machine does not start after turning the start switch to the ON position, it may be that the starting power fuse has blown. Open the service cover and check. If the fuse has blown, please contact your sales or service agent.

Note: The fuse is a large fuse used in high current applications. Like ordinary fuses, they function as fuses, protecting electrical components and wiring from damage caused by excessive current.

Precautions for external maintenance power supply

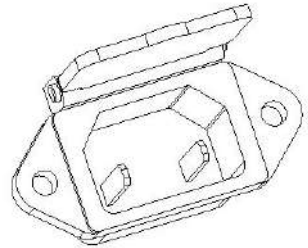

Note: The external power supply is limited to 12V15A. Can not be charged.



Restart after Refueling

Air exhausting from Fuel System

Important: Do not rotate the engine by starter motor to get ready the fuel system. This will probably cause overheating of starter motor to damage coil, pinion, and/or ring gear.

Important: If the engine stops due to shortage of fuel, please add fuel, rotate the key to ON for 60s, and then rotate it to START position. Running the starter motor for a long time before the supply of sufficient fuel will cause start failure of starter

2. Turn the starter key to the ON position and hold it for about 60 seconds..

Note: The air content in the fuel system will cause start failure or other problems of engine. Ensure to exhaust when the fuel tank is empty or the fuel system contains air.

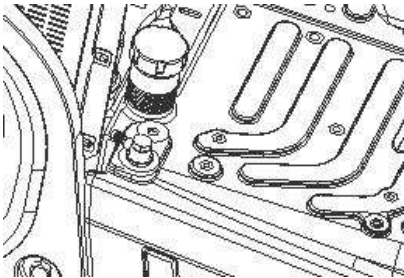

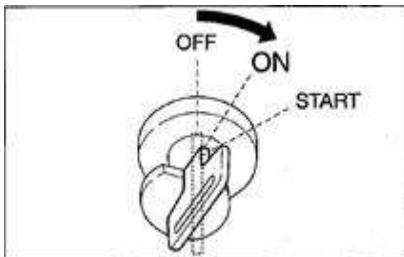

1. Add fuel.



**Flashing of Warning Lamps**

If a warning tone is heard or a warning lamp starts to flash during operations, park the machine in a safe place and take the following remedy measures.

Warning lamp	Lamp name	Cause and solution
	Charging warning lamp	<p>There is a problem with charging.</p> <p>If the light continues to flash after maintenance, there may be a problem with the charger. If you need help, please consult your sales or service agent.</p>
	Engine oil pressure indicator lamp	<p>The engine lubrication system is internally malfunctioned.</p> <p>Check the engine oil level.</p> <p>If this lamp flashes when the oil level is normal or still flashes after adding of oil, please consult with your sales or service dealer.</p> <p>Refer to page 5-18 “Checking and adding of engine oil”.</p>



Other Symptoms

For the symptoms not listed in table below or the further existed problems after appropriate solutions, please consult with your sales or service dealer.

Problem	Cause	Solutions
The left and right joysticks cannot move flexibly	<ul style="list-style-type: none">● Lack of grease on left and right joysticks	<ul style="list-style-type: none">● Lubricate the joystick
Throttle lever cannot move flexibly	<ul style="list-style-type: none">● The throttle line is loose	<ul style="list-style-type: none">● Adjust or replace (consult your sales or service agent).
Bucket, slewing or walking operations cannot be performed	<ul style="list-style-type: none">● The safety lock lever has been raised (locked)● The travel lock adjustment is faulty	<ul style="list-style-type: none">● Lower (release) the safety lock lever. Please refer to page 2-11.● Adjust the walking lock (consult your sales or service agent).
Not enough digging power	<ul style="list-style-type: none">● Hydraulic oil level is too low● The hydraulic oil is not hot enough● Air filter is clogged● Incorrect hydraulic oil type	<ul style="list-style-type: none">● Add to the specified liquid level. Please refer to page 5-17.● Clean the air filter. Please refer to page 5-27.● Replace hydraulic oil. Please refer to page 5-34.
Unable to walk or inflexible	<ul style="list-style-type: none">● Stone or foreign object stuck	<ul style="list-style-type: none">● Remove foreign objects
The machine turns right/left	<ul style="list-style-type: none">● A stone or foreign object is stuck.● The track tension adjustment is faulty	<ul style="list-style-type: none">● Remove foreign objects● Adjust the track to the specified tension. Please refer to page 5-21.



Troubleshooting Other Symptoms

Problem	Cause	Solutions
Can't turn or turn inflexibly	<ul style="list-style-type: none">● Insufficient grease for slewing support	<ul style="list-style-type: none">● Lubricate the bearings Please refer to page 5-23
The hydraulic oil temperature is too high	<ul style="list-style-type: none">● Hydraulic oil level is too low	<ul style="list-style-type: none">● Add to the specified liquid level. Please refer to page 5-17
The starter motor rotates but the engine does not start	<ul style="list-style-type: none">● Insufficient fuel● There is air in the fuel system● Water in the fuel system	<ul style="list-style-type: none">● Add fuel. Please refer to page 5-16.● Exclude air. Please refer to pages 6-8.● Drain the water. Please refer to pages 5-24.
Tracks fall off	<ul style="list-style-type: none">● Tracks are too loose	<ul style="list-style-type: none">● Increase the tension. Please refer to page 5-21.
The engine emits black smoke from time to time	<ul style="list-style-type: none">● Air filter is clogged	<ul style="list-style-type: none">● Clean the air filter. Please refer to pages 5-27.
Engine exhausts white or blue smoke	<ul style="list-style-type: none">● Too much oil● Inferior fuel	<ul style="list-style-type: none">● Adjust to the specified liquid level. Please refer to page 5-16.● Change the fuel.
The engine produces irregular noise (combustion or mechanical noise)	<ul style="list-style-type: none">● Inferior fuel is being used	<ul style="list-style-type: none">● Replace the fuel
	<ul style="list-style-type: none">● overheat of engine	For details, please refer to "If the Engine Overheats" on page 6-3.
	<ul style="list-style-type: none">● Internal damage of exhaust pipe	<ul style="list-style-type: none">● Replace the exhaust pipe. For replacement matters, please consult your sales or service agent.



Towing



Warning

During towing, the improper operations, the incorrect use of rope, or the improper checking will cause serious injuries or deaths.

- The breakage or disengagement of rope can cause danger. Use ropes compatible with the towing force.
- Do not use any kinked, twisted, or even damaged rope.
- Do not suddenly apply heavy load onto the rope.
- Please wear safety gloves during the handling of rope.
- Ensure that an operator is assigned each on the towing machine and the towed machine.
- Do not operate the towing operation on a slope.
- Keep all personnel away from the rope during towing.

Important: Do not tow the machine when the engine is not started or the machine is not running. Otherwise, the towed machine will probably be damaged.

Important: Please ensure to abide by the following procedure when the machine is towed by traction hole. The negligence of any

of following steps will probably damage the traction hole or other framework part.

Towing of Machine

Use the following procedure to drag a heavy object or a machine entrapped in mud.

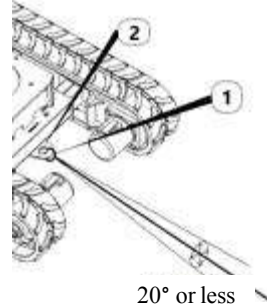

- Permissible force: 28.2KN
1. Affix the rope to the hook ring (1).
 2. Hook the hook ring (1) to the traction hole (2).
 3. Ensure that the rope maintains a 20° or smaller angle with the traveling frame.
 4. Move the machine to tension the rope.
 5. Drive the machine at 2km/h or lower speed to a position (Easy for repairs) within a short range from the site.

Parameter



**Applicable models: XN12-9**

XN12-9	Technical parameters	Unit		
Overall weight		kg	1123	1130
Bucket capacity		m ³	0.02	0.02
Type of working device			Backhoe	Backhoe
Engine	Model		Kubota D902	Yanmar3TNV74
	Displacement	L	0.898	0.993
	Rated output power/speed	kw/r/min	11.8/2300	11.2/2400
	Maximum torque/rotating speed	N.m/t/min	51.3/1800	51.8/100
Speed	Maximum traveling speed (High/low)	km/h	1.5	1.3
	Slewing speed	rpm	11	11
	Maximum grade ability		30%	30%
Track sub assembly	Ground pressure	k Pa	34.64	29.9
	Material		Rubber	Rubber
	Tension control type		Tightening cylinder	Tightening cylinder
Type of pump			gear pump	gear pump
Fuel/oil/fluid pressure and capacity	Working pressure	Mpa	16	16
	Flow	(L/min)	18.4	19
	Hydraulic oil tank capacity	(L)	16	15
	Fuel tank capacity	(L)	11	11

All ratings of the machine are obtained when the machine is operating on a solid horizontal support surface. If the working environment conditions of the machine differ from the above-mentioned reference conditions (Such as the operations on uneven ground and slope), the operator shall take these conditions into consideration.



Applicable models: XN12-9

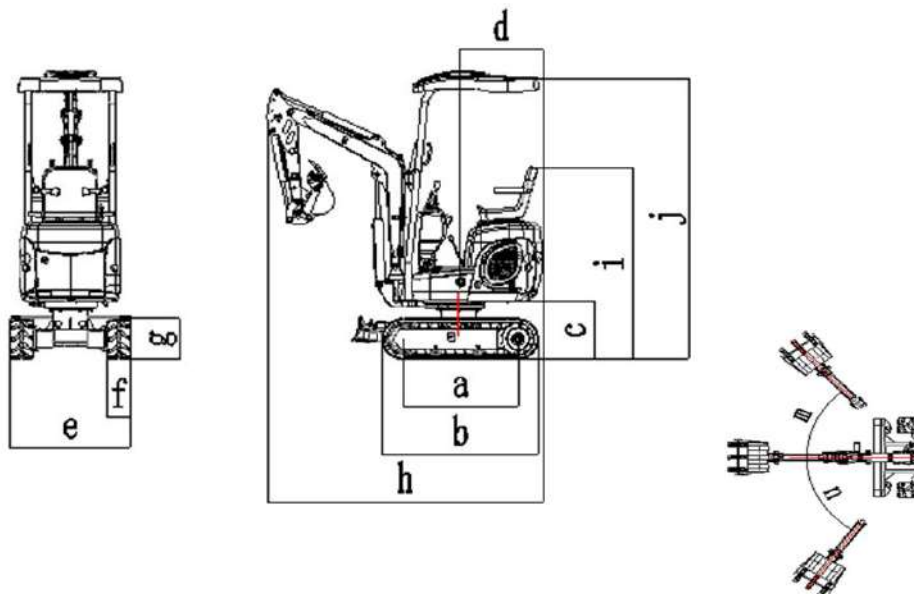

	Overall dimensions	Unit: mm
a	Wheel track	910
b	Overall length of crawler	1235
c	Ground clearance of platform	460
d	Tail slewing radius of platform	660
e	Chassis width	800-950
f	Track width	180
g	Track height	320
h	Transport length	2170/2850
i	Ground clearance of seat	1520
j	Overall height	2270
m	Boom slewing - right	50°
n	Boom slewing - left	55°



Parameter

Operating Range

Applicable models: XN12-9

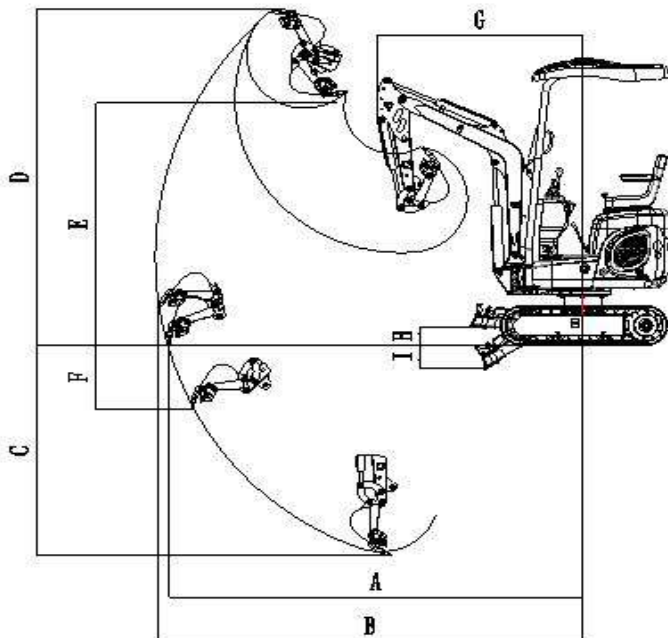

	Working range	Unit: mm
A	Ground maximum digging radius	3040
B	Maximum digging radius	3135
C	Maximum digging depth	1580
D	Maximum digging height	2620
E	Maximum Dump height	2000
F	Maximum vertical digging depth	1580
G	Minimum slewing radius	1510
H	Maximum lifting height of bulldozing blade	140
I	Maximum digging depth of bulldozing blade	200



Parameter

Machine lifting power

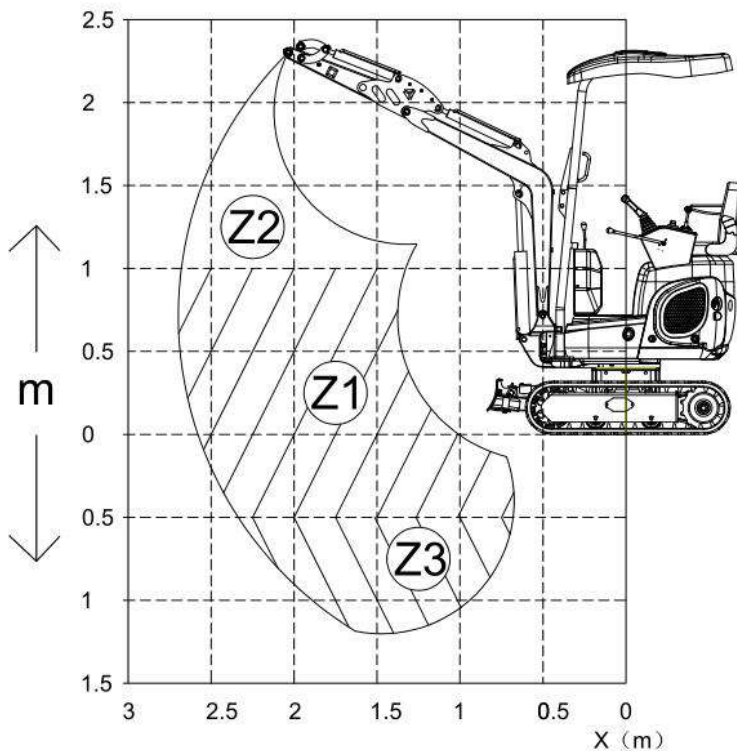

XN12-9					kg
	1m	1.5m	2m	2.5m	MAX
Z2	—	310	260	290	—
Z1	520	440	360	260	280
Z3	540	370	310	—	—

Records

Accessories





General Safety Measures Safety Measures



Warning

Please take the following safety measures while disassembling or installing attachments.

- Please consult with Ken stone Heavy Machinery before installing optional products.
- Do not use any attachment not approved by Ken stone Heavy Machinery. Otherwise it will probably cause safety issues or cause adverse influence on operations or life of machine.
- Ken stone Heavy Machinery will not be liable for any injury, accident, or product damage arising from the use of non-approved attachments.
- Select a stable and level working zone. Ensure to park the machine in a well-ventilated place.
- Remove obstacles and dangerous objects and immediately clear any splashed fuel.
- During lifting, ensure to assign one person as signaler. For detailed procedure and measures, please follow the instructions of the signaler.
- If it's necessary to place temporarily heavy weights or accessories onto the ground during disassembling or installation, please ensure to place them in a steady place.
- During lifting, keep all personnel away from working zone. There is probably a danger of object falling or contact with personnel in the working zone.
- Use a crane to move heavy weights ($\geq 25\text{kg}$).
- Ensure to properly support the heavy weights before movement. While lifting a load by a crane, notice the gravity center of the load and keep balance the machine.
- Do not operate the machine when a load is lifted by a crane.
- Follow the correct procedures to install boom and bucket arm, otherwise it will probably result in serious injuries. If the help is needed, please consult with your sales or service dealer.

Precautions for Installation of Working Device

Ensure to fulfill commissioning after the replacement with optional product or other special attachment. Check the hydraulic oil level and if necessary add oil. For detailed



installation/disassembling procedures of attachments, please consult with your sales or service dealer.

Precautions for Operations of Attachment



Warning

The extended attachment will deteriorate the machine stability. While the machine is traveling or slewing on a steep slope, the imbalance will probably result in rollover. Do not take the following operations, otherwise it will be extremely dangerous.



Driving down a steep slope with attachment lifted



Driving laterally on a steep slope



Slewing on a steep slope

If a heavy attachment is installed, while stopping the machine, the impulsion force of the machine will be larger than usual value before the complete stop. Please carefully take the distance into consideration to prevent impact against surrounding objects. Keep a safe distance from surrounding obstacles.

If a heavy attachment is installed, the gravity lowering (Slow lowering of attachment under the action of dead weight when the



attachment is stopped in the air) will speed up.

The machine is more vulnerable to rollover in lateral direction than longitudinal direction.

- (1) Do not slew laterally when the bucket working device is heavily loaded.
Especially, do not slow laterally on a slope.
- (2) For a machine with installed breaking hammer or grinder, the attachment is heavier than the installed standard bucket. Do not operate this machine laterally, especially during the down slope digging.

Please carefully take the distance into consideration to prevent impact against surrounding objects of machine and keep a safe spacing from surrounding obstacles.



Precautions for Operations of Attachment



Warning

- Please consult with Ken stone Heavy Machinery before installing optional products.
- Do not use any attachment not approved by Ken stone Heavy Machinery. Otherwise it will probably cause safety issues or cause adverse influence on operations or life of machine.
- Ken stone Heavy Machinery will not be liable for any injury, accident, or product damage arising from the use of non-approved attachments.
- If a bucket in width of >450M installed, the swing stop block must be installed. If no swing stop block is installed, it will probably result in impact of bucket with machine body.



Hydraulic Breaking Hammer

For the operations of breaking hammer, please refer to the separately provided manual of hydraulic breaking hammer.



Warning

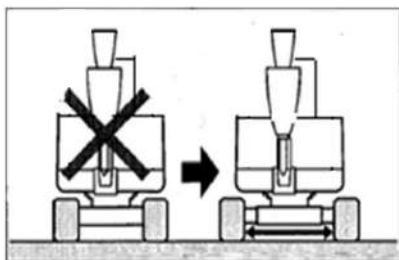

Do not use breaking hammer when the track width becomes narrower.

- **Always operate the machine with extended track width of 950mm, in order to improve the machine stability to the maximum extent. Operating the machine with narrow track width (800mm) will probably result in rollover of machine due to poor stability.**
- **If it's necessary to operate the machine with narrow track width (800mm), retract the bucket working device and lower the boom to reduce the gravity center and face the machine towards front before traveling.**

While operating the optional products such as breaking hammer, tipping bucket, and grab bucket, ensure that the track width is extended to 950mm.

Important: While installing an attachment, ensure that it's suitable for the machine model in use.

If the recommendations are required for the choice of attachment, please contact your sales or service dealer.



Precautions for Operations

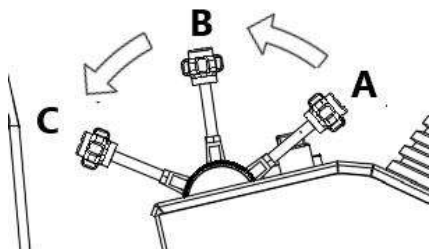

- Start the engine and run at 75% of maximum speed.

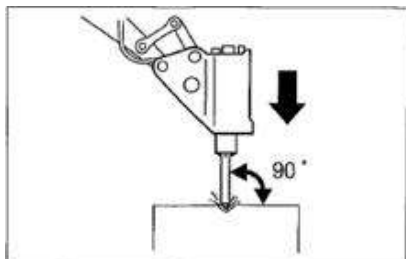

- Perform the crushing operation by placing the hammer head perpendicular to the working face.
- During the crushing operations, appropriately aim the hammer head at the object to be crushed and avoid the air impact.



- Do not pry by hammer head or pry during breaking.
- Do not move the hammer head during crushing.
- Do not impact one same surface continuously for >30s.

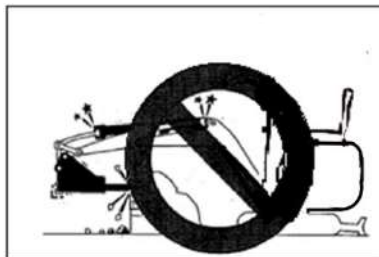

- Do not crush when the cylinder is fully extended or retracted (at travel end). Reserve at least 50mm travel.

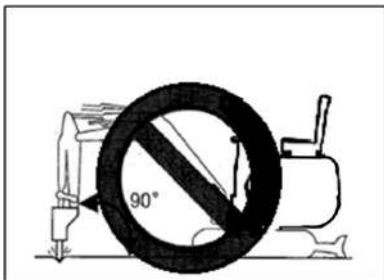

- Do not crush when the bucket arm is perpendicular to the ground.

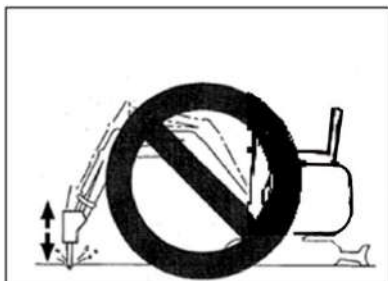

- Do not crush any object to be impacted by the gravity drop of breaking hammer.
- Do not use the breaking hammer to move any object or rock to be crushed.
- Slew the machine occasionally to cool down the engine.
- In event of abnormal vibration of hydraulic pipes, the nitrogen in the accumulator is probably leaking. Please check as soon as possible.

Periodical Replacement of Hydraulic Oil

With installed hydraulic breaking hammer, the hydraulic oil deteriorates faster than the normal operations. Ensure to replace the hydraulic oil and oil return filter element.

- The failure to replace timely will result in damage of machine and breaking hammer hydraulic system. To prolong the life of hydraulic system, ensure to replace the hydraulic oil and oil return filter element after the hours listed in table below.
- During the replacement of hydraulic oil, clean the oil suction filter screen.

Replacement period (Hour)

Item	Hydraulic oil	Filter element
1 st time	—	25
2 nd time	—	100
Periodic	1200(600)	200

By taking the breaking hammer operating ratio of 100% for instance.



Accessories



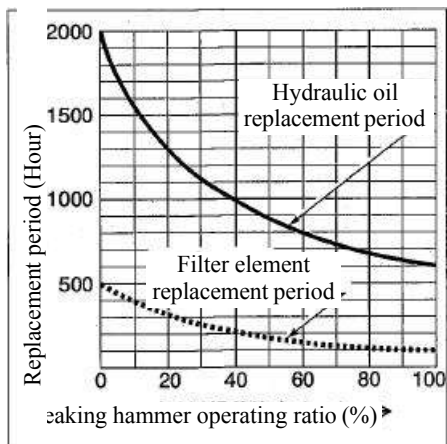





Hydraulic Hammer

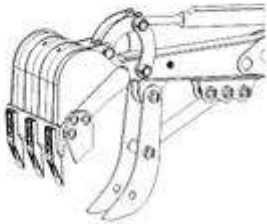

(): For the use of common anti-wear hydraulic oil.

Records

Optional accessories

Auger		Ripper	
Thumb part		Quick hitch	
Grab		Rake	
Digging bucket		Tilt bucket	
200mm			600mm
300mm			
500mm			
600mm			
700mm			
800mm			
900mm			

Optional accessories

Canopy

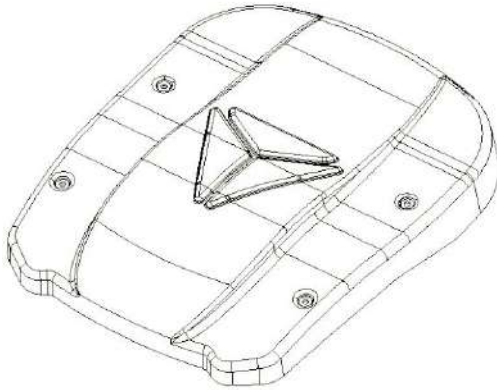

Parts number position

Upper-frame number

☆20060001☆

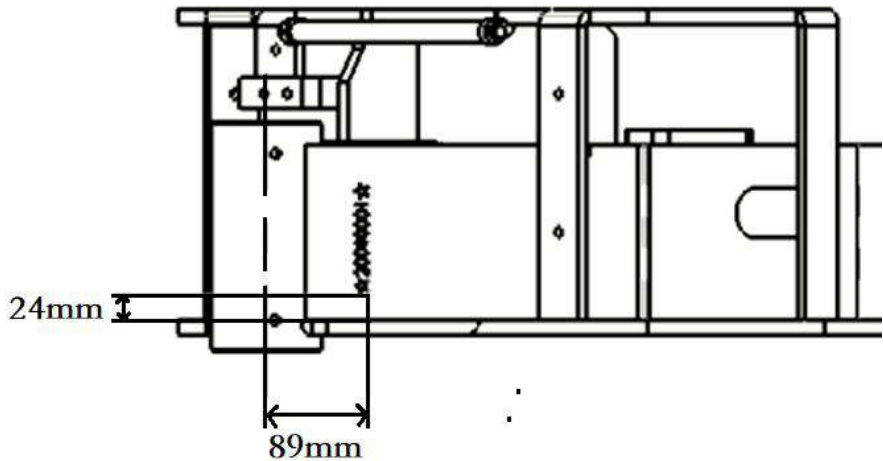

Operating manual

XN12-9 Mini crawler excavator

Editor: Hongrui Zhang
2021. 12

The information in this manual is subject to change without notice.

Version 1, December, 2021

SHANDONG KEN STONE HEAVY MACHINERY CO., LTD.
ADD: DINGYUANZHAI INDUSTRIAL PARK, GUAN
COUNTY, SHANDONG PROVINCE
POST CODE: 252512
SERVICE LINE: +86-635-8362550

<https://tractormanualz.com/>